

Upgrading to OES—Best Practices Guide

Open Enterprise Server 2 SP3

January 21, 2013

Legal Notices

Novell, Inc., makes no representations or warranties with respect to the contents or use of this documentation, and specifically disclaims any express or implied warranties of merchantability or fitness for any particular purpose. Further, Novell, Inc., reserves the right to revise this publication and to make changes to its content, at any time, without obligation to notify any person or entity of such revisions or changes.

Further, Novell, Inc., makes no representations or warranties with respect to any software, and specifically disclaims any express or implied warranties of merchantability or fitness for any particular purpose. Further, Novell, Inc., reserves the right to make changes to any and all parts of Novell software, at any time, without any obligation to notify any person or entity of such changes.

Any products or technical information provided under this Agreement may be subject to U.S. export controls and the trade laws of other countries. You agree to comply with all export control regulations and to obtain any required licenses or classification to export, re-export or import deliverables. You agree not to export or re-export to entities on the current U.S. export exclusion lists or to any embargoed or terrorist countries as specified in the U.S. export laws. You agree to not use deliverables for prohibited nuclear, missile, or chemical biological weaponry end uses. See the [Novell International Trade Services Web page \(http://www.novell.com/info/exports/\)](http://www.novell.com/info/exports/) for more information on exporting Novell software. Novell assumes no responsibility for your failure to obtain any necessary export approvals.

Copyright © 2009 Novell, Inc. All rights reserved. No part of this publication may be reproduced, photocopied, stored on a retrieval system, or transmitted without the express written consent of the publisher.

Novell, Inc., has intellectual property rights relating to technology embodied in the product that is described in this document. In particular, and without limitation, these intellectual property rights may include one or more of the U.S. patents listed on the [Novell Legal Patents Web page \(http://www.novell.com/company/legal/patents/\)](http://www.novell.com/company/legal/patents/) and one or more additional patents or pending patent applications in the U.S. and in other countries.

Novell, Inc.
1800 South Novell Place
Provo, UT 84606
U.S.A.
www.novell.com

Online Documentation: To access the latest online documentation for this and other Novell products, see the [Novell Documentation Web page \(http://www.novell.com/documentation\)](http://www.novell.com/documentation).

Novell Trademarks

For Novell trademarks, see the [Novell Trademark and Service Mark list \(http://www.novell.com/company/legal/trademarks/tmlist.html\)](http://www.novell.com/company/legal/trademarks/tmlist.html).

Third-Party Materials

All third-party trademarks are the property of their respective owners.

Contents

About This Guide	9
1 Frequently Asked Questions	11
1.1 Why Not Stay on NetWare?	11
1.2 What About My Older NetWare Servers?	12
1.3 What's New in OES 2?	12
1.4 What Do Novell Customers Recommend?	12
1.5 What Are the Differences Between NetWare and OES 2?	14
1.5.1 System and Administrative User and Group Differences	14
1.5.2 Comparing Services Between NetWare and OES 2	15
1.5.3 Services Not Included in OES 2	21
1.6 How Much Training Is Needed?	22
1.6.1 What Our Customers Tell Us.	22
1.6.2 Conduct a Training Assessment	22
1.7 What Training Is Available?	23
1.7.1 Novell Training Services	23
1.7.2 Complimentary Free Training	24
1.7.3 Product Documentation	24
1.8 Does Novell Have Community Support to Help Me with My Migration?	24
2 Getting Started	25
2.1 Assessing Your Current Network	25
2.1.1 Running Novell Support Advisor	25
2.1.2 Recording Your Current Network Information	25
2.2 Identifying Needed Improvements	27
2.2.1 Server Hardware Considerations	28
2.2.2 Consolidation Considerations	29
2.2.3 Virtualization Considerations	29
2.2.4 File System Considerations	30
2.2.5 Method Considerations	30
2.2.6 Network Considerations	30
2.2.7 eDirectory/LDAP Considerations	30
2.2.8 Time Synchronization	31
2.2.9 Cluster Considerations	31
2.2.10 Application Compatibility Considerations	31
2.2.11 LAN/WAN Connection Considerations	32
3 Upgrading eDirectory to OES	33
3.1 About eDirectory in OES 2	33
3.1.1 The Role of eDirectory in OES 2	33
3.1.2 eDirectory Version Considerations	34
3.1.3 About eDirectory Management Tools in OES 2	35
3.2 Planning Your eDirectory Upgrade	36
3.2.1 Deciding Whether to Redesign Your Tree	36
3.2.2 Checking eDirectory Health	38
3.2.3 For More Information	40
3.3 Upgrading eDirectory	40
3.3.1 Do Not Install or Upgrade to eDirectory 8.8 Separately from OES 2	40

3.3.2	Choosing an Upgrade Strategy	40
3.3.3	Moving, Creating, or Importing eDirectory Users	41
3.4	Post-Upgrade Checks	42
3.5	About Domain Services for Windows	42
3.6	Additional eDirectory Resources	45

4 Upgrading NSS and Data Storage to OES 47

4.1	About NSS in OES 2	47
4.1.1	NSS Is Designed for the Enterprise	47
4.1.2	More Reasons to Consider NSS	47
4.2	Platform Differences in NSS	48
4.3	Planning to Upgrade NSS	48
4.3.1	Identify NSS Coexistence and Migration Issues	48
4.3.2	Limitations	49
4.4	Moving NSS and Data	50
4.4.1	Moving NSS Devices Cross-Platform	50
4.4.2	Moving Data from NSS on NetWare to NSS on OES 2	50
4.4.3	Moving Data from NSS to Other Volume Types	51
4.5	Post-Upgrade Procedures	51
4.6	Upgrading Distributed File Services (DFS) to OES	52

5 Upgrading File Services to OES 53

5.1	Upgrading AFP File Services to OES	53
5.1.1	About AFP File Services in OES 2	53
5.1.2	Platform Differences in AFP File Services	54
5.1.3	Planning to Transfer AFP Services	56
5.1.4	Upgrading AFP	56
5.1.5	Post-Upgrade Checks	57
5.2	Upgrading CIFS File Services to OES	57
5.2.1	About CIFS File Services in OES 2	57
5.2.2	Platform Differences in CIFS File Services	58
5.2.3	Planning to Upgrade CIFS Services	59
5.2.4	Upgrading CIFS	60
5.2.5	Post-Upgrade Checks	61
5.3	Upgrading Novell FTP to OES	61
5.3.1	About FTP File Services	61
5.3.2	Platform Differences in FTP File Services	61
5.3.3	Planning	61
5.3.4	Transferring FTP Services to OES	62
5.3.5	Post-Upgrade Checks	62
5.4	Upgrading iFolder to OES	62
5.4.1	About iFolder on OES 2	62
5.4.2	Platform Differences in iFolder File Services	64
5.4.3	Planning	64
5.4.4	Upgrading iFolder	65
5.4.5	Post-Upgrade Checks	65
5.5	Upgrading NetWare Core Protocol (NCP) File Services	65
5.5.1	About NCP File Services in OES 2	65
5.5.2	Planning to Upgrade NCP File Services	67
5.5.3	Only Data Transfers Are Required	68
5.6	Upgrading NetStorage	68
5.6.1	About NetStorage	68
5.6.2	Platform Differences in NetStorage File Services	70
5.6.3	NetStorage Is Not Transferred	71

6	Upgrading Print Services to OES	73
6.1	About iPrint	73
6.2	Platform Differences in iPrint	73
6.3	Planning to Upgrade iPrint to OES	73
6.3.1	Requirements and Recommendations	74
6.3.2	Limitations	74
6.4	Upgrading iPrint to OES	75
6.5	Additional Information	75
7	Upgrading QuickFinder to OES	77
7.1	About QuickFinder in OES 2	77
7.2	Platform Differences in QuickFinder	77
7.3	Planning to Upgrade QuickFinder	78
7.4	Upgrading QuickFinder to OES	78
7.5	Post-Upgrade Considerations	78
8	Upgrading Backup Services to OES	79
8.1	Upgrading Novell Archive and Versioning Services to OES	79
8.1.1	About Archive and Versioning Services in OES 2	79
8.1.2	Platform Differences in Archive and Versioning Services	79
8.1.3	Planning to Upgrade Archive and Versioning Services	79
8.1.4	Upgrading Archive and Versioning Services	80
8.1.5	Post-Upgrade Procedures	80
8.2	About Upgrading Storage Management Services (SMS)	80
9	Upgrading Network Services to OES	81
9.1	Upgrading DNS Services to OES	81
9.1.1	About Novell DNS in OES 2	81
9.1.2	Platform Differences in Novell DNS	81
9.1.3	Planning to Upgrade Novell DNS	81
9.1.4	Upgrading DNS	82
9.2	Upgrading DHCP Services to OES	82
9.2.1	About Novell DHCP in OES 2	82
9.2.2	Platform Differences in Novell DHCP	83
9.2.3	Planning to Upgrade Novell DHCP	83
9.2.4	Upgrading DHCP	83
9.3	Time Synchronization	83
9.3.1	About Time Synchronization in OES 2	83
9.3.2	Planning to Upgrade Time Synchronization Services	84
9.3.3	Transferring Time Synchronization Services	85
9.4	Service Location Protocol (SLP)	85
9.4.1	About SLP in OES 2	85
9.4.2	Platform Differences in SLP Services	85
9.4.3	Setting Up SLP on OES 2	86
10	Upgrading Novell Cluster Services to OES	89
10.1	Overview	89
10.2	Planning to Upgrade Novell Cluster Services	90
10.2.1	Reviewing the Current Cluster	90
10.2.2	Upgrading Novell Cluster Services to OES 2	90
10.2.3	Additional Information	91
10.3	Prerequisites	91

10.4	Caveats	92
10.5	Rolling Cluster Conversions.....	92
11	Upgrading Other Novell Products to OES	93
11.1	GroupWise 7 and GroupWise 8	93
11.1.1	Source Platform Requirements	93
11.1.2	Target Platform Requirements.....	93
11.1.3	Preparing to Migrate	94
11.1.4	Caveats	94
11.1.5	Tool Options	94
11.1.6	Migration Instructions	95
11.1.7	Migrating GroupWise as Part of a Transfer ID Migration.....	95
11.1.8	Additional Information	96
11.2	Identity Manager	97
11.3	ZENworks	97
11.3.1	Upgrading to ZENworks 10 Configuration Manager	97
11.3.2	Migrating ZENworks 7 from NetWare to Linux	97
12	About Third-Party Applications	99
A	Tools for Upgrading to OES 2 SP3	101
A.1	OES 2 SP3 Migration Tool	101
A.1.1	Consolidating Selected Data or Services	101
A.1.2	Transferring an Entire NetWare Server	102
A.1.3	More About Using the Migration Tool	102
A.2	Server Consolidation and Migration Tool (SCMT)	103
A.3	NetWare Migration Wizard	103
A.4	Additional Information	103
B	About the Management Tools in OES 2	105
B.1	Novell iManager 2.7	105
B.1.1	What's New in Version 2.7	105
B.1.2	Supported Web Browsers	106
B.1.3	Caveats	106
B.1.4	Upgrading to iManager 2.7	106
B.2	Novell Remote Manager (NRM)	106
B.2.1	Prerequisites	107
B.2.2	About Novell Remote Manager and OES 2	107
B.3	About Other Management Tools	107
C	Workstation Considerations	109
D	Server Consolidation	111
E	Examples	113
E.1	Replica and CA Server Migration	113
E.1.1	Overview	113
E.1.2	FAQs	114
E.1.3	Preparing and Transferring Your Replica Server.....	114
E.1.4	Post-Migration Configuration	115
E.2	Cluster Migration	115

E.2.1	Overview	115
E.2.2	General Notes and Tips	116
E.2.3	Preparing to Migrate the Cluster	116
E.2.4	Transferring DHCP in the Cluster	117
E.2.5	Transferring DNS in a Cluster	118
E.2.6	iPrint Migration in a Cluster	120
E.2.7	Transferring AFP in a Cluster	122
E.2.8	Transferring CIFS in a Cluster	122
E.3	Server Identity Migration	122
E.3.1	Preparing and Transferring Your Replica Server	123
E.3.2	Post-Migration Steps	124

F Documentation Updates

127

About This Guide

Open Enterprise Server (OES) 2 SP3 is the next generation of the Novell® services that have long been valued by a wide variety of businesses and other organizations, ranging from small businesses to multi-national enterprises.

When you install OES 2 SP3, you install SUSE® Linux Enterprise Server (SLES) 10 SP4 as the core OS and the OES 2 SP3 components as an “add-on product.”

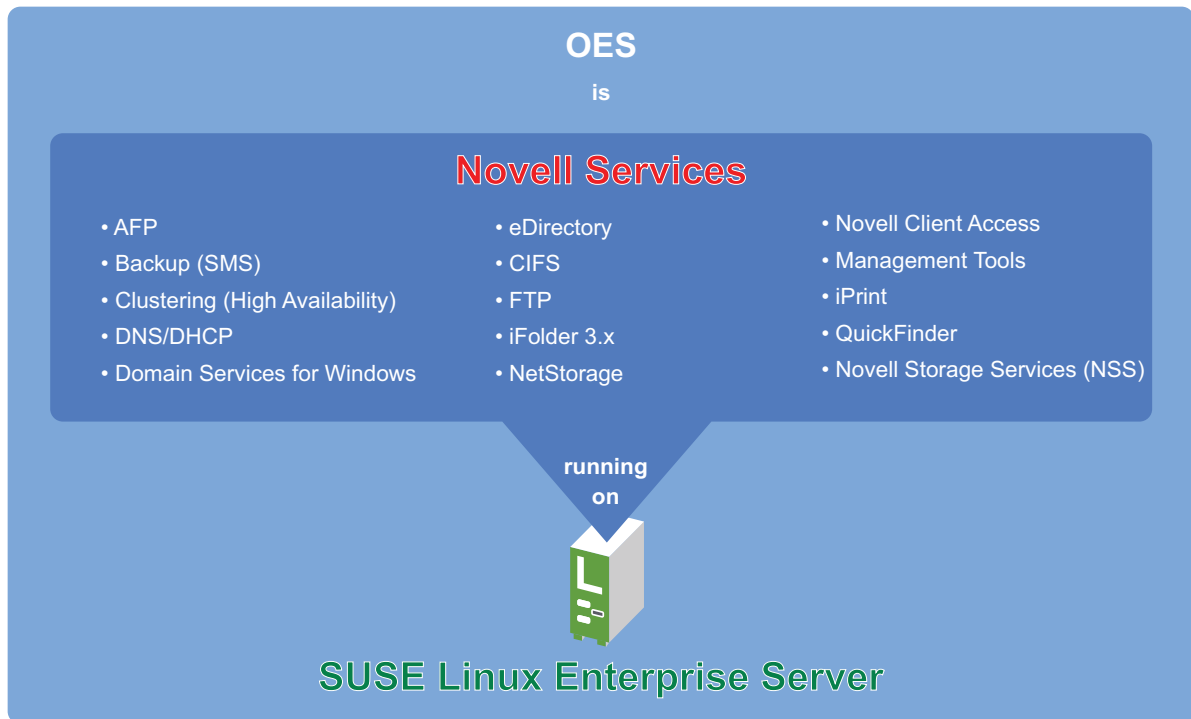

What This Guide Provides

This guide provides an overview of the planning and implementation processes involved in upgrading from NetWare® to OES 2 SP3. It provides overview and planning information along with links to specific implementation instructions.

What This Guide Does Not Replace

This guide does not replace the specific upgrading and planning instructions found in the regular installation and migration guides that you should follow carefully to ensure a successful upgrade to OES.

Audience

This guide is intended for network administrators.

Feedback

We want to hear your comments and suggestions about this manual and the other documentation included with this product. Please use the User Comments feature at the bottom of each page of the online documentation to enter your comments.

Documentation Updates

For the most recent version of this guide, see the [OES 2 Documentation Web site \(http://www.novell.com/documentation/oes2/upgrade_to_oes_lx/data/front.html\)](http://www.novell.com/documentation/oes2/upgrade_to_oes_lx/data/front.html).

Documentation Conventions

In Novell documentation, a greater-than symbol (>) is used to separate actions within a step and items in a cross-reference path.

A trademark symbol (®, ™, etc.) denotes a Novell trademark. An asterisk (*) denotes a third-party trademark.

When a single pathname can be written with a backslash for some platforms or a forward slash for other platforms, the pathname is presented with a backslash. Users of platforms that require a forward slash, such as Linux* or UNIX*, should use forward slashes as required by your software.

1 Frequently Asked Questions

You probably have a few questions up front. Here are some answers.

- ♦ [Section 1.1, “Why Not Stay on NetWare?”](#) on page 11
- ♦ [Section 1.2, “What About My Older NetWare Servers?”](#) on page 12
- ♦ [Section 1.3, “What’s New in OES 2?”](#) on page 12
- ♦ [Section 1.4, “What Do Novell Customers Recommend?”](#) on page 12
- ♦ [Section 1.5, “What Are the Differences Between NetWare and OES 2?”](#) on page 14
- ♦ [Section 1.6, “How Much Training Is Needed?”](#) on page 22
- ♦ [Section 1.7, “What Training Is Available?”](#) on page 23
- ♦ [Section 1.8, “Does Novell Have Community Support to Help Me with My Migration?”](#) on page 24

1.1 Why Not Stay on NetWare?

There are distinct advantages to moving to OES 2 over staying on NetWare®. Gartner has issued [report](http://mediaproducts.gartner.com/reprints/novell/vol2/article4/article4.html) (<http://mediaproducts.gartner.com/reprints/novell/vol2/article4/article4.html>) which you should find enlightening. Novell has also published a [technical white paper](http://www.novell.com/rc/docrepository/public/37/basedocument.2009-03-19.8740935430/OES%20v%20WIN%20FINAL_en.pdf) (http://www.novell.com/rc/docrepository/public/37/basedocument.2009-03-19.8740935430/OES%20v%20WIN%20FINAL_en.pdf) on this subject.

Here are a few of the benefits of upgrading to OES 2.

- ♦ **NetWare Enters Extended Support in 2010:** As Novell® has stated for a number of years now, NetWare enters its extended support phase in 2010.
- ♦ **Continued Hardware Support:** When NetWare enters extended support, hardware vendors will cease to certify it on new server hardware.
- ♦ **Continued Third-party Solutions Support:** As hardware vendors cease certification support, third-party software solutions providers, such as anti-virus and backup software vendors, will stop developing for the NetWare platform.
- ♦ **Dynamic Storage Technology:** This breakthrough Novell technology drastically reduces storage costs and runs only on OES 2, not on NetWare. However, NSS volumes on NetWare can be assigned as secondary volumes in a pair.
- ♦ **iFolder 3.8:** NetWare supports only Novell iFolder® 2.x, which lacks important features found in the latest version, such as automatic server provisioning, multiple iFolders per user, iFolder sharing between users, reassigning iFolder ownership, provisioning for LDAP groups, and numerous administrative enhancements.
- ♦ **Open Source Solutions:** Open source initiatives such as Apache* and Tomcat* have been supported on NetWare only as Novell or others have ported them to the platform, but they are automatically available on OES.

- ♦ **Xen virtualization technology:** This no-cost virtualization solution runs on OES 2 servers and lets you create NetWare virtual machines for those services that you want to keep on NetWare for the time being.
- ♦ **Domain Services for Windows:** This OES 2 technology integrates eDirectory™ and Active Directory* users as well as Windows* and Novell file services.
- ♦ **File Systems:** OES 2 not only supports the Novell Storage Services™ (NSS) file system, but also traditional Linux file systems, such as Ext3, XFS, and Reiser FS.
- ♦ **OES Services enhancements:** As Novell OES services continue to evolve, the new features and technologies are almost always only available on OES 2.

1.2 What About My Older NetWare Servers?

Earlier versions of NetWare should be upgraded to OES 2 as outlined in [Table 1-1](#).

Table 1-1 Upgrade Paths from Earlier Versions of NetWare

NetWare Version	Minimum DS Version	Tool to Use	Other Information
NetWare 4.11 SP9	NDS® 6.21	n/a	You must perform a down-server upgrade to NetWare 5.1 SP8 as an interim step.
NetWare 4.2	NDS 6.21	n/a	You must perform a down-server upgrade to NetWare 5.1 SP8 as an interim step.
NetWare 5.0 SP6a	NDS 7.62c of 8.85c	n/a	You must perform a down-server upgrade to NetWare 5.1 SP8 as an interim step.
NetWare 5.1 SP8	eDirectory 8.7.3.7 or later	OES 2 Migration Tool	For more information, see “ Transfer ID Migration ” in the OES 2 SP3: Migration Tool Administration Guide .
NetWare 6.0 SP5	eDirectory 8.7.3.7 or later	OES 2 Migration Tool	For more information, see “ Transfer ID Migration ” in the OES 2 SP3: Migration Tool Administration Guide .

1.3 What’s New in OES 2?

The “[What’s New or Changed](#)” section in the [OES 2 SP3: Planning and Implementation Guide](#) includes brief summaries of the new features and services in OES 2 plus a list of links to the What’s New sections in each OES 2 guide. We recommend you take a few minutes to look at the section. The list is quite impressive.

1.4 What Do Novell Customers Recommend?

Periodically, Novell polls customers to get a reality check. The table below summarizes customer advice from a survey of OES 2 customers.

Table 1-2 From a Recent Novell Customer Survey

Customer Tip

Learn basic Linux skills first (before starting) or have someone handy. Make sure you:

- ◆ Understand the Linux file system and rights.

For help, see “[Understanding Directory Structures in Linux POSIX File Systems](#)” in the *OES 2 SP3: File Systems Management Guide* and “[Aligning NCP and POSIX File Access Rights](#)” in the *OES 2 SP3: Planning and Implementation Guide*

- ◆ Know Linux command line tools for the equivalent NetWare commands (DSTrace, DSRepair, etc.). Learn the commands by setting up a test server and playing out the scenario you want to see on your production server.

For help, see the *OES2 SP3: Linux Tips for NetWare Administrators* guide.

- ◆ Understand that in-house Linux expertise is a necessary prerequisite. (The good news is that fully 89% of survey respondents who have deployed OES 2 discovered that they already had Linux expertise on their deployment teams.)

For help, see [Section 1.6, “How Much Training Is Needed?”](#) on page 22 and [Section 1.7, “What Training Is Available?”](#) on page 23.

Plan ahead and know your NetWare, OES, and eDirectory environments very well:

- ◆ Make sure eDirectory is clean and that you are current on all patches.
- ◆ Plan the deployment scenario and find the holes and gotchas.
- ◆ Plan data locations, file systems, and LUM configuration objects.
- ◆ Perform a complete inventory of all applications (and their dependencies) before you get too far into planning in case they or their dependencies can't be moved to OES/SLES.

Upgrade slowly and cautiously, but start now

- ◆ Start in small scale (a couple of servers) or just move DHCP for a couple of weeks, then DNS for a couple of weeks, then GroupWise®, WebAccess, etc.
- ◆ Be careful; you can harm your OES production environment if you don't understand what you are doing; don't start with your most important servers.

Test, test, test.

- ◆ Test everything multiple times, including third-party products like backup solutions, before full deployment.
- ◆ Create an initial test box if you don't have previous Linux experience.

For help, see the *OES 2 SP3: Getting Started with OES 2 and Virtualized NetWare*.

- ◆ Use VMware* (or other virtualization products) and install many times to get the feel for it, then test, test, test.

Give it a try.

- ◆ Moving to OES 2 is easy and relatively painless.

Start your upgrade in a lab environment first and play with the product.

Customer Tip

- ♦ Try installing Linux at home and use it as your primary OS.
- ♦ Make sure you have a test environment that mimics your production installation.

It works the same as NetWare.

- ♦ The Novell management Interfaces look the same. iPrint, iManager, etc.—all of the benefits of NetWare are available on OES 2.

Don't freak out about service and management differences

- ♦ Learn the iMonitor and iManager Web tools for service and server management.
- ♦ Become familiar with the basic management commands, such as `ndsconfig` for eDirectory management.

Do your homework and read everything you can find.

- ♦ Scour the discussion forums and see what problems others are having and how they solved them, ask questions, and make notes.

Avoid mixing OES 2 and NetWare, if possible.

- ♦ Create separate servers providing other services such as DNS, DHCP, etc., on OES first to gain familiarity with Linux as a whole.

YaST is your friend.

- ♦ It's not always the answer, though. Learn which things are best configured in the configuration files and which things you really should use YaST for.

Find out how well your hardware vendor supports Linux.

- ♦ Make sure your hardware vendor not only “supports Linux,” but also provides regular driver updates for the version of SLES you are planning to deploy.
-

1.5 What Are the Differences Between NetWare and OES 2?

- ♦ [Section 1.5.1, “System and Administrative User and Group Differences,”](#) on page 14
- ♦ [Section 1.5.2, “Comparing Services Between NetWare and OES 2,”](#) on page 15
- ♦ [Section 1.5.3, “Services Not Included in OES 2,”](#) on page 21

1.5.1 System and Administrative User and Group Differences

Because OES 2 services run on Linux rather than on NetWare, there are noticeable differences between the system and administrative users and groups on OES 2 servers. For example, many OES 2 services, Novell CIFS require proxy users to retrieve service-related information and service attributes, and in some cases to write service information in eDirectory.

For more information, see “[System User and Group Management in OES 2 SP3](#)” and “[Administrative Users in OES 2 SP3](#)” in the *OES 2 SP3: Planning and Implementation Guide*.

1.5.2 Comparing Services Between NetWare and OES 2

Table 1-3 Service Comparison Between NetWare 6.5 SP8 and OES 2

Service	NetWare 6.5 SP8	OES 2	Platform Differences / Migration Issues
Access Control Lists	Yes	Yes	In combination with NCP™ Server, Linux supports the Novell® trustee model for file access on NSS volumes and NCP volumes on Linux.
AFP (Apple* File Protocol)	Yes - NFAP	Yes - Novell AFP	AFP services on NetWare and OES are proprietary and tightly integrated with eDirectory™ and Novell Storage Services (NSS).
Apache Web Server	Yes - NetWare® port of open source product	Yes - Standard Linux	<p>Administration Instance vs. Public Instance on NetWare (http://www.novell.com/documentation/nw65/web_apache_nw/data/aipcu6x.html#aipcu6x).</p> <p>What's Different about Apache on NetWare (http://www.novell.com/documentation/nw65/web_apache_nw/data/ail8hvj.html) .</p>
Archive and Version Services (Novell)	Yes	Yes	Setup varies slightly, but there are no functional differences.
Backup (SMS) <ul style="list-style-type: none"> ◆ SMS ◆ NSS-Xattr 	Yes	Yes	<p>SMS provides backup applications with a framework to develop complete backup and restore solutions. For information, see the OES 2 SP3: Storage Management Services Administration Guide for Linux.</p> <p>NSS provides extended attribute handling options for NSS on Linux. For information, see “Using Extended Attributes (xAttr) Commands” in the OES 2 SP3: NSS File System Administration Guide for Linux.</p>
CIFS (Windows File Services)	Yes - NFAP	Yes - Novell CIFS and Novell Samba	<p>Both NFAP and Novell CIFS are Novell proprietary and tightly integrated with eDirectory and Novell Storage Services (NSS).</p> <p>Samba is an open source product distributed with SUSE® Linux Enterprise Server (SLES).</p> <p>Novell Samba is enhanced by Novell with configuration settings for eDirectory LDAP authentication via Linux User Management (LUM). Novell Samba is not tightly integrated with NSS on Linux and works with any of the “File Systems Available on OES 2 Servers.” (See the OES 2 SP3: Planning and Implementation Guide.)</p>

Service	NetWare 6.5 SP8	OES 2	Platform Differences / Migration Issues
Clustering	Yes	Yes	<p>“Product Features” in the OES 2 SP3: Novell Cluster Services 1.8.8 Administration Guide for Linux.</p> <p>“Product Features” in the NW6.5 SP8: Novell Cluster Services 1.8.5 Administration Guide.</p>
DFS (Novell Distributed File Services)	Yes	Yes	In combination with NCP Server, DFS supports junctions and junction targets for NSS volumes on Linux and NetWare. DFS also supports junction targets for NCP volumes on non-NSS file systems such as Reiser and Ext3. The VLDB command offers additional options to manage entries in the VLDB for NCP volumes.
DHCP	Yes	Yes	<p>For a comparison between what is available on OES 2 and NetWare, see “DHCP Differences Between NetWare and OES 2” in the OES 2 SP3: Planning and Implementation Guide.</p> <p>To plan your DHCP implementations, see “Planning a DHCP Strategy” in the OES 2 SP3: Novell DNS/DHCP Administration Guide and “Planning a DHCP Strategy” in the NW 6.5 SP8: Novell DNS/DHCP Services Administration Guide.</p>
DNS	Yes	Yes	<p>For a comparison between what is available on OES 2 and NetWare, see “DNS Differences Between NetWare and OES 2” in the OES 2 SP3: Planning and Implementation Guide.</p> <p>See “Planning a DNS Strategy” in the OES 2 SP3: Novell DNS/DHCP Administration Guide and “Planning a DNS Strategy” in the NW 6.5 SP8: Novell DNS/DHCP Services Administration Guide.</p>
Dynamic Storage Technology	No	Yes	DST runs on OES 2. An NSS volume on NetWare is supported only as the secondary volume in a shadow pair. When using DST in a cluster, each of the NSS volumes in a shadow pair must reside on OES 2.
eDirectory 8.8	Yes	Yes	No functional differences.
eDirectory Certificate Server	Yes	Yes	No functional differences.

Service	NetWare 6.5 SP8	OES 2	Platform Differences / Migration Issues
eGuide (White Pages)	Yes	No	This functionality is now part of the Identity Manager 3.6 User Application. For more information, see the Identity Manager 3.6 Documentation Web Site . (http://www.novell.com/documentation/idm36/index.html).
FTP Server	Yes	Yes	Support for eDirectory LDAP authentication has been added to PureFTP on OES 2. The FTP/SFTP gateway available on NetWare is not currently available on Linux. See " FTP Services ". See " Features of the NetWare FTP Server " in the <i>NW 6.5 SP8: Novell FTP Administration Guide</i> .
Health Monitoring Services	Yes	Yes	The Health Monitoring Server, which was included in OES 1, has been removed in OES 2. This is now available in various Novell Remote Manager dialog boxes on both platforms. For more information, see " Health Monitoring Services " in the <i>OES 2 SP3: Planning and Implementation Guide</i> .
Identity Manager 3.6.1 Bundle Edition	No	Yes	IDM 3.6.1 is not available on NetWare.
iPrint	Yes	Yes	See " Overview " in the <i>OES 2 SP3: iPrint for Linux Administration Guide</i> , and " Overview " in the <i>NW 6.5 SP8: iPrint Administration Guide</i> .
IPX™ (Internetwork Packet Exchange™) from Novell	Yes	No	Novell has no plans to port IPX to OES.
iSCSI	Yes	Yes	The iSCSI target for Linux does not support eDirectory access controls like the NetWare target does. Nor is the iSCSI initiator or target in OES 2 integrated with NetWare Remote Manager management. You use YaST management tools instead. On the other hand, the iSCSI implementation for Linux is newer and performs better. See Linux-iSCSI Project on the Web (http://linux-iscsi.sourceforge.net). See " Overview " in the <i>NW 6.5 SP8: iSCSI 1.1.3 Administration Guide</i> .
LDAP Server for eDirectory	Yes	Yes	No functional differences.

Service	NetWare 6.5 SP8	OES 2	Platform Differences / Migration Issues
Multipath Device Management	Yes	Yes	NetWare uses NSS multipath I/O. Linux uses Device Mapper - Multipath that runs underneath other device management services.
MySQL*	Yes - NetWare port of open source product	Yes - Standard Linux	See MySQL.com on the Web (http://www.mysql.com) . See “ Overview: MySQL ” in the <i>NW 6.5 SP8: Novell MySQL Administration Guide</i> .
NCP Volumes	No	Yes	NCP Server on Linux supports creating NCP volumes on Linux POSIX file systems such as Reiser and Ext3. For information, see “ Managing NCP Volumes ” in the <i>OES 2 SP3: NCP Server for Linux Administration Guide</i> .
NCP Server	Yes	Yes	NCP services are native to NetWare 6.5 and NSS volumes; to have NCP services on OES, the NCP Server must be installed. See “ Benefits of NCP Server ” in the <i>OES 2 SP3: NCP Server for Linux Administration Guide</i> .
NetStorage	Yes	Yes	NetStorage on Linux offers connectivity to storage locations through the CIFS, NCP, and SSH protocols. NetWare uses only NCP. These and other differences are summarized in “ NetStorage ” in the <i>OES 2 SP3: Planning and Implementation Guide</i> .
NetWare Traditional File System	Yes	No	Novell has no plans to port the NetWare Traditional File System to Linux.
NetWare Traditional Volumes	Yes	N/A	
NFS	Yes - NFAP	Yes - native to Linux	For NetWare, see “ Working with UNIX Machines ” in the <i>NW 6.5 SP8: AFP, CIFS, and NFS (NFAP) Administration Guide</i> .
NICI (Novell International Cryptography Infrastructure)	Yes	Yes	No functional differences.
NMAS™ (Novell Modular Authentication Services)	Yes	Yes	No functional differences.
Novell Audit	Yes	No	Novell Audit is not included with OES. However, the Novell Audit 2.0 Starter pack is available for download at no cost on Novell.com (http://www.novell.com/downloads) .

Service	NetWare 6.5 SP8	OES 2	Platform Differences / Migration Issues
Novell Client™ for Windows and Linux support	Yes	Yes	Novell Client connectivity to OES 2 requires that the NCP Server be installed.
Novell Cluster Services™	Yes	Yes	See “ Product Features ” in the <i>OES 2 SP3: Novell Cluster Services 1.8.8 Administration Guide for Linux</i> . See “ Product Features ” in the <i>NW6.5 SP8: Novell Cluster Services 1.8.5 Administration Guide</i> .
Novell iFolder® 2.x	Yes	No	For migration information, see “ Migrating iFolder 2.x ” in the <i>OES 2 SP3: Migration Tool Administration Guide</i>
Novell iFolder 3.8	No	Yes	OES 2 includes Linux, Macintosh*, and Windows clients.
Novell Licensing Services	Yes	No	See “ OES 2 Doesn't Support NLS ” in the <i>OES 2 SP3: Planning and Implementation Guide</i> .
NSS (Novell Storage Services™)	Yes	Yes	Most NSS services are available on both platforms. For a list of NSS features that are not used on Linux, see “ Cross-Platform Issues for NSS ” in the <i>OES 2 SP3: NSS File System Administration Guide for Linux</i> .
NTPv3	Yes	Yes	The <code>ntpd.conf</code> file on NetWare can replace an OES server's NTP configuration file without modification.
OpenSSH	Yes	Yes	Netware includes a port of the open source product. Linux includes the open source product itself. See “ Functions Unique to the NetWare Platform ” in the <i>NW 6.5 SP8: OpenSSH Administration Guide</i> .
PAM (Pluggable Authentication Modules)	No	Yes	PAM is a Linux service that Novell leverages to provide eDirectory authentication. eDirectory authentication is native on NetWare.
Pervasive.SQL*	Yes	No	Pervasive.SQL is available for Linux from the Web (http://docs.pervasive.com/products/database/psqlv11/wwhelp/wwhimpl/js/html/wwhelp.htm#href=welcome/libwelcome.html) .
PKI (Public Key Infrastructure)	Yes	Yes	No functional differences.
Printing	Yes	Yes	See “ iPrint ” in the <i>OES 2 SP3: Planning and Implementation Guide</i> .
QuickFinder™	Yes	Yes	

Service	NetWare 6.5 SP8	OES 2	Platform Differences / Migration Issues
RADIUS	Yes	Yes	See the information on forge.novell.com (http://forge.novell.com/modules/xfmod/project/?edirfreeradius) .
Samba	No	Yes	Samba is an open source technology available on OES. Novell provides automatic configuration for authentication through eDirectory. For more information, see the OES2 SP3: Samba Administration Guide .
Search (QuickFinder)	Yes	Yes	<p>When indexing a file system, the QuickFinder engine indexes only what it has rights to see.</p> <p>On NetWare, it has full access to all mounted volumes. On Linux, it has rights to only the files that the novlwww user in the www group has rights to see.</p> <p>For more information, see “Security Characteristics” and “Generating an Index For a Linux-Mounted NSS Volume” in the OES 2 SP3: Novell QuickFinder Server 5.0 Administration Guide.</p>
SLP	Yes - Novell SLP	Yes - OpenSLP	<p>For OES 2, see “SLP Services in the Network” (http://www.novell.com/documentation/sles10/book_sle_reference/data/cha_slp.html) in the SLES 10 SP4: Installation and Administration Guide (http://www.novell.com/documentation/sles10/book_sle_reference/data/book_sle_reference.html) and “Implementing the Service Location Protocol” (http://www.novell.com/documentation/edir87/edir87/data/a2iimc.html).</p> <p>NetWare uses Novell SLP, which provides caching of Directory Agent scope information in eDirectory. This provides for sharing of scope information among DAs.</p> <p>Novell SLP is not available on Linux. OpenSLP on Linux is not customized to provide DA synchronization. Therefore, DA synchronization is only available for eDirectory on NetWare.</p>
Software RAIDS (NSS volumes)	Yes (0, 1, 5, 10, 15)	Yes (0, 1, 5)	See “ Understanding Software RAID Devices ” in the OES 2 SP3: NSS File System Administration Guide for Linux .

Service	NetWare 6.5 SP8	OES 2	Platform Differences / Migration Issues
Storage Management Services™ (SMS)	Yes	Yes	No functional differences, except that the SBCON backup engine is not supported on Linux. The nbackup engine is available for exploring SMS capabilities, but in a production environment, you should use a third-party, full-featured backup engine.
TCP/IP	Yes	Yes	No functional differences.
Timesync NLM™	Yes	No	Timesync will not be ported to Linux. However, NTPv3 is available on both Linux and NetWare. See “ Time Services ” in the <i>OES 2 SP3: Planning and Implementation Guide</i> .
Tomcat	Yes	Yes	NetWare includes Tomcat 4 and a Tomcat 5 servlet container for iManager 2.7. OES 2 includes Tomcat 5. There is no impact to any of the OES 2 administration tools, which are tested and supported on both platforms. See “ Administration Instance vs. Public Instance on NetWare ” (http://www.novell.com/documentation/nw65/web_tomcat_nw/data/ahdyran.html#ahdyran)
Virtual Office (Collaboration)	Yes	No	Virtual Office has been replaced by Novell Teaming + Conferencing. A separate purchase is required. For more information, see the Novell Teaming + Conferencing Web Site (http://www.novell.com/products/teaming/index.html).
WAN Traffic Manager	Yes	No	
Xen Virtualization Guest	Yes	Yes	NetWare 6.5 SP8 (and NetWare 6.5 SP 7) can run on a paravirtualized machine. OES 2 can run on a paravirtualized machine or fully virtualized machine.
Xen Virtualization Host Server	N/A	Yes	

1.5.3 Services Not Included in OES 2

See “[eGuide, IFolder 2, and Virtual Office Are Still Available on Netware](#)” in the *NW 6.5 SP8: Planning and Implementation Guide*.

1.6 How Much Training Is Needed?

- ◆ [Section 1.6.1, “What Our Customers Tell Us,” on page 22](#)
- ◆ [Section 1.6.2, “Conduct a Training Assessment,” on page 22](#)

1.6.1 What Our Customers Tell Us

Some customers have found that their administrators need Linux training. Novell provides several training courses to help bring administrators up to speed with administering OES services on Linux. Familiar tools, such as iManager and Novell Remote Manager (NRM), and utilities such as NSSMU are also used to administer Novell services on OES 2. Many administrators are pleasantly surprised when they see that their knowledge and skills apply very well to managing Novell services on OES 2.

We recognize that time and resources are a problem for customers, and we recommend following the example of one of our customers: Four months prior to rollout, Novell provided OES and SLES training for their administrators at their site and on their hardware and software.

When we survey customers, they consistently tell us they want training that addresses:

- ◆ Differences in day-to-day support and management versus NetWare
- ◆ How to install and upgrade existing NetWare servers to OES 2
- ◆ Differences between NetWare and OES: services, features, and interoperability
- ◆ Troubleshooting

1.6.2 Conduct a Training Assessment

Novell recommends that you conduct a training needs assessment. You should determine whether current skill sets are absent, adequate, or proficient, so that you can recommend a training package. Three levels of Linux expertise are recommended:

Table 1-4 *Recommended Linux Training Levels*

Level of Expertise	Training Needed	Qualities of Potential Candidates
Certified Linux Expert	You will probably want at least some of your technical staff to be Linux certified (LPI level 1 and/or LPI level 2). Many third-party Linux certification courses are available to meet this need.	<ul style="list-style-type: none">◆ Are typically already UNIX (AIX*, Solaris*, etc.) experts.◆ Have some Linux experience.◆ Are willing to attend additional class and lab sessions.◆ Are willing to serve as trainers and mentors.◆ Have accredited certifications.

Level of Expertise	Training Needed	Qualities of Potential Candidates
Linux Administrator	<p>Novell recommends SUSE Linux-specific training.</p> <p>Novell offers a variety of instructor-led and self-study certification and training options including Novell Advanced Technical Training (ATT), which is highly recommend.</p> <p>The comprehensive courses address a wide range of advanced topics including support issues, in-depth architectural reviews, and enterprise solutions. ATT classes provide real-world expertise that can be put to immediate use.</p>	<ul style="list-style-type: none"> ◆ Are currently UNIX or NetWare administrators who are willing to expand skills ◆ Have data center and server farm administrative experience. Deep technical skills are less important. ◆ Have expertise in services above the OS level. OS knowledge is necessary.
Linux Support Staff	<p>Support staff need to be knowledgeable about how specific network services (eDirectory, edge services, iPrint, etc.) work on Linux.</p> <p>Novell offers service-specific courses for most major services.</p>	<ul style="list-style-type: none"> ◆ Support current file, print, and other network systems. ◆ Will need to move to more Linux support, but system focus will remain the same.

1.7 What Training Is Available?

Here are some of the avenues you can use to get the training you need:

- ◆ [Section 1.7.1, "Novell Training Services," on page 23](#)
- ◆ [Section 1.7.2, "Complimentary Free Training," on page 24](#)
- ◆ [Section 1.7.3, "Product Documentation," on page 24](#)

1.7.1 Novell Training Services

Novell certification and training options change periodically as new needs are identified and courses are developed. To learn more about these and other training options, visit the OES Novell training Web site at www.novell.com/training (<http://www.novell.com/training/courseware/catalog.jsp?pl=7660>).

- ◆ To find the dates and local availability of the Novell Advanced Technical Training and other Novell offerings, go to: www.novell.com/training/pep/map.html (<http://www.novell.com/training/att/map.html>).
- ◆ To request additional information on Novell Advanced Technical Training, send an e-mail to technicaltraining@novell.com (<mailto:technicaltraining@novell.com>)
- ◆ To subscribe to the Technical Training Newsletter, see <http://www.novell.com/info/list> (<http://www.novell.com/company/subscribe/>)

1.7.2 Complimentary Free Training

For a good introduction to OES, see [Bridging NetWare Skills to Novell Open Enterprise Server for Linux](http://www.novell.com/training/promotions/netwaretolinux/modules.html) (<http://www.novell.com/training/promotions/netwaretolinux/modules.html>)

To help you get started with OES and Linux, Novell also provides some [training material at no cost on the Web](http://www.novell.com/training/complimentary/) (<http://www.novell.com/training/complimentary/>).

1.7.3 Product Documentation

Yes, the old adage is true: “If all else fails, read the documentation.” This document contains numerous cross-references to sections relative to a specific topic or service. If you can't find what you need on Novell's documentation site, add a comment, tell us what we missed, and we'll see that you get the answer you need. Open Enterprise 2 documentation is available at the following URL: <http://www.novell.com/documentation/oes2/index.html> (<http://www.novell.com/documentation/oes2/index.html>).

One especially useful guide for those who are transitioning from NetWare to OES and Linux is the *OES2 SP3: Linux Tips for NetWare Administrators* guide. Novell partner [BrainStorm, Inc.](http://www.brainstorminc.com/oes) (<http://www.brainstorminc.com/oes>) provides a printed Administrator's Command Reference card based on the tips guide; it shows common NetWare commands and their OES/Linux counterparts. This reference card is nicely formatted and very helpful in bridging the gap between NetWare and OES/Linux commands.

And finally, Novell also publishes all of the [SLES 10 documentation on the Web](http://www.novell.com/documentation/sles10/index.html) (<http://www.novell.com/documentation/sles10/index.html>).

1.8 Does Novell Have Community Support to Help Me with My Migration?

There are a two good places to connect with other administrators, ask questions, and find answers to your specific migration questions.

- ♦ [Novell Forums](http://forums.novell.com/) (<http://forums.novell.com/>)
- ♦ [Cool Solutions Upgrade to OES Community Page](http://www.novell.com/communities/cool-solutions/upgrade-to-oes) (<http://www.novell.com/communities/cool-solutions/upgrade-to-oes>)

There is a list of the top [TIDs](http://www.novell.com/communities/node/8781/top-oes-upgrade-tids) (<http://www.novell.com/communities/node/8781/top-oes-upgrade-tids>) to help you troubleshoot and deal with migration issues.

Finally, you can get OES information from Twitter by following [NovelloES](http://www.twitter.com/novelloes) (<http://www.twitter.com/novelloes>), and there's a [FaceBook Page](http://www.facebook.com/desktopapp.php?api_key=97e8a45d27cbe2bd96a957cb9cd22f10#/pages/I-Upgraded-to-Novell-Open-Enterprise-Server-on-SUSE-Linux-Enterprise/154405544072?ref=ts) (http://www.facebook.com/desktopapp.php?api_key=97e8a45d27cbe2bd96a957cb9cd22f10#/pages/I-Upgraded-to-Novell-Open-Enterprise-Server-on-SUSE-Linux-Enterprise/154405544072?ref=ts) as well.

2 Getting Started

You can ensure a successful upgrade by

- ♦ [Section 2.1, “Assessing Your Current Network,” on page 25](#)
- ♦ [Section 2.2, “Identifying Needed Improvements,” on page 27](#)

2.1 Assessing Your Current Network

- ♦ [Section 2.1.1, “Running Novell Support Advisor,” on page 25](#)
- ♦ [Section 2.1.2, “Recording Your Current Network Information,” on page 25](#)

2.1.1 Running Novell Support Advisor

To ensure you are equipped with the latest pre-upgrade information and area aware of known issues, we recommend you validate your OES upgrade readiness using the Novell Support Advisor 1.1 (or later) tool. For more information and to obtain this free tool, access the [Novell Support Advisor Web page \(http://support.novell.com/advisor\)](http://support.novell.com/advisor).

2.1.2 Recording Your Current Network Information

Whether you will be upgrading on your own, using Novell® Global Services, or working with another consulting firm, you need a complete and accurate record of your current network setup.

- 1 If you don't already have one, create one or more diagrams of your network, including the following information:
 - ♦ Router/switch/subnet/firewall diagrams; note particularly any blocked ports
 - ♦ Current WAN configuration, including link speeds for all sites running NetWare®. Duplicate the following tables or use a spreadsheet, as necessary, to accommodate multiple sites.

Table 2-1 *Sample WAN Environment Overview*

Site Location	WAN Speed	# of Servers	Server Breakdown
Home Office	Local	25	3-NW4.11 3-NW5.0 4-NW5.1 3-NW6.0 3-NW6.5 5-W2K3 2-W2K 2-RHEL3

Table 2-2 *Sample WAN Location Environment Overview*

Site Location	# of NetWare Servers	NetWare Versions	Server Notes	# of Clients	Client Breakdown	Client Notes
Southwest Office	6	2-NW4.11 1-NW5.1 3-NW6.5	All NetWare are being retired. Users will be moved to OES 2 servers	30	4-Win98 6-W2K 20-WinXP	Win9x clients will be migrated to Windows XP Professional SP2

- 2 If you don't already have a current directory design document, create one that includes:
 - ◆ NDS®/eDirectory™ tree diagrams.
 - ◆ Partition and replication diagrams.
 - ◆ NDS versions, such as NDS v6, v7, and/or v8.
 - ◆ Versions of NDS/eDirectory that are installed on non-NetWare operating systems.
 - ◆ Other Novell applications that are directly dependent on eDirectory, such as Novell Account Management, DirXML®, and Identity Manager.
 - ◆ Any bindery contexts currently in use, including a brief description of how they are used.
- 3 List all of the NetWare servers in your tree along with their context, IP address information, and any other information you might need as you plan to migrate them.
- 4 Identify any NetWare traditional (non-NSS) volumes being used on your NetWare servers.
- 5 Identify the file services provided by NetWare servers, including AFP, CIFS, iFolder, NetStorage, FTP, and NCP™ (Novell Client™), then list the servers that provide them and the contexts of the users that use them.

- 6 Identify the printers that are serviced by NetWare servers, along with the print services associated with them, including iPrint, NDPS-based printing, and legacy queue-based printing.
- 7 Identify any in-house applications developed specifically for NetWare and briefly describe the services that these provide.
- 8 Identify other Novell products, such as GroupWise®, ZENWorks®, or Identity Manager that are currently running on NetWare, and verify which of these are supported on OES 2 SP3.
- 9 Document how your e-mail infrastructure is currently set up.
- 10 Identify any third-party applications currently running on the NetWare servers, such as backup/restore and anti-virus solutions.

Verify with the vendors whether these applications are supported on SLES 10/OES 2 SP3 and whether they are Novell YES Approved.

Specify which applications will be ported to OES 2 SP3 and which must continue to run on NetWare for the time being.
- 11 List any databases (critical or otherwise) that are stored on NetWare servers.
- 12 Create a design document that outlines your network service configurations, including time synchronization, SLP, DNS, DHCP, and any other network protocols or services that might be impacted by an upgrade to OES, such as IPX™.
- 13 Collect any standards documents you have, such as server standards and naming standards.
- 14 Collect or document the hardware information for your NetWare servers, including processor specs, RAM configuration and storage adapters.
- 15 Document any NetWare clusters in your network, both Novell Clustering Services™ clusters and Business Continuity Clustering clusters. Specify the function of each cluster node, including service failover configurations.
- 16 Specify any security standards that must be met on OES/Linux. Unlike NetWare, Linux security is much more modular/granular.

The tables in the next section suggest additional information you might need to collect before you begin planning your upgrade to OES.

2.2 Identifying Needed Improvements

- ♦ [Section 2.2.1, “Server Hardware Considerations,” on page 28](#)
- ♦ [Section 2.2.2, “Consolidation Considerations,” on page 29](#)
- ♦ [Section 2.2.3, “Virtualization Considerations,” on page 29](#)
- ♦ [Section 2.2.4, “File System Considerations,” on page 30](#)
- ♦ [Section 2.2.5, “Method Considerations,” on page 30](#)
- ♦ [Section 2.2.6, “Network Considerations,” on page 30](#)
- ♦ [Section 2.2.7, “eDirectory/LDAP Considerations,” on page 30](#)
- ♦ [Section 2.2.8, “Time Synchronization,” on page 31](#)
- ♦ [Section 2.2.9, “Cluster Considerations,” on page 31](#)
- ♦ [Section 2.2.10, “Application Compatibility Considerations,” on page 31](#)
- ♦ [Section 2.2.11, “LAN/WAN Connection Considerations,” on page 32](#)

2.2.1 Server Hardware Considerations

How is your server hardware holding up? Do you need to invest in some new hardware for the upgrade to OES 2 SP3 to succeed?

Many customers tell us that choosing the right hardware is not a straightforward task.

Your best bet is to start with the [Novell OES Partner Products page \(http://www.novell.com/partnerguides/section/677.html\)](http://www.novell.com/partnerguides/section/677.html), particularly the [Server Hardware List \(http://www.novell.com/partnerguides/section/677.html#c_531\)](http://www.novell.com/partnerguides/section/677.html#c_531).

If you don't already have an agreement with a hardware vendor, all Novell Partners deserve consideration. Be sure to communicate with your chosen hardware vendors regarding server sizing guidelines to ensure that you select the right server and hardware configuration.

[Table 2-3](#) outlines both "minimum" and "recommended" requirements for running OES 2 SP3.

NOTE: The RAM and disk space amounts shown in [Table 2-3](#) are for system components only. The OES 2 components you install might require additional RAM and disk space.

Table 2-3 *Minimum and Recommended Hardware Requirements*

System Component	Minimum	Recommended
Computer	Server-class computer with Intel Pentium* II or AMD * K7 450 MHz processor	Server-class computer that has been certified by the hardware vendor for SLES 10 SP4. Pentium III, Pentium III Xeon *, Pentium 4, Intel * Xeon 700 MHz, AMD K8 CPUs (Athlon* 64 and Opteron*), Intel EM64T or higher processor.
Memory	1 GB of RAM	2 GB of RAM
Free Disk Space	10 GB of available, unpartitioned disk space.	20 GB of available, unpartitioned disk space. Additional disk space might be required depending on which OES components are selected and how they are used.
CD-ROM Drive	4X CD-ROM or DVD drive if installing from physical media	48X CD-ROM drive or DVD drive if installing from physical media.
Network Board	Ethernet 100 Mbps	
Storage Adapter	N/A	When determining what hardware bus adapters (HBAs) to use for SAN-attached OES 2 servers, take all of the software and hardware components into account. Linux drivers are available for almost all enterprise-class HBAs and many of them are OES 2 certified. However, hardware vendors tend to be more restrictive with certification than the operating system is. Any HBA used with OES 2 must be certified by both the storage vendor for a specific model as well as the Fibre Channel switch vendor.

System Component	Minimum	Recommended
IP Address	<ul style="list-style-type: none"> ◆ One IP address on a subnet ◆ Subnet mask ◆ Default gateway 	Internet connectivity from the server in order to complete registration and configure patches
Mouse	N/A	USB or PS/2
Server Computer BIOS	If you are doing a CD-ROM installation, prepare the BIOS on your server computer so that it boots from the CD-ROM drive first.	

2.2.2 Consolidation Considerations

This might be a good time to consider taking advantage of today's more powerful hardware platforms and doing some server consolidation. Server consolidation often pays off in lower hardware costs, as well as lower cooling, power consumption, and rack space costs. For example, Novell recently consolidated fourteen older file and print servers to two new servers.

Which combinations of eDirectory, file, print, GroupWise, WebAccess, etc., might reasonably work together on the same host server?

2.2.3 Virtualization Considerations

To help with the transition from NetWare to OES 2, virtualization has been optimized in OES 2 so that you can run NetWare 6.5. SP7 and later as a paravirtualized guest operating system on OES servers.

Doing this provides another option for running NetWare-dependent applications and services. For example, most third-party NLM™ software can be accommodated this way until suitable alternatives can be developed for Linux.

Which NetWare-dependent applications and services will you need to run on an interim basis as part of your transition to OES 2? Will virtualization help with this?

Installing Hosts: For information about installing a virtual machine host and setting up virtual machines in general, see *Virtualization with Xen* (http://www.novell.com/documentation/sles10/xen_admin/data/bookinfo.html), particularly "Setting Up Virtual Machines" (http://www.novell.com/documentation/sles10/xen_admin/data/xen_virtualization_vm.html).

Installing Guest Operating Systems: For information about installing NetWare as a guest operating system, see "Installing and Managing NetWare on a Xen-based VM" in the *OES 2 SP3: Installation Guide*. For information about installing OES 2 SP3 as a guest operating system, "Installing, Upgrading, or Updating OES on a Xen-based VM" in the *OES 2 SP3: Installation Guide*.

2.2.4 File System Considerations

Which file system should be used: Linux traditional volumes (ReiserFS and ext3), NSS, or another file system?

- ◆ Does it make sense to have different servers using different file systems depending on the server's primary role?
- ◆ Are you already using Novell Storage Services™ (NSS) volumes on NetWare?

If so, you should probably preserve all the rights, metadata, and trustee information associated with the data on those volumes, so it makes sense to stay with Novell Storage Services.

- ◆ Are your volumes already in a SAN environment with NSS?

If so, switching to a SAN environment that uses NSS on Linux is quite easy. Using DFS junctions also requires NSS to support volume moves and splits. And if business continuity clusters are in your plans, you might find them easier to implement if you're using NSS.

NOTE: For Groupwise under Linux, the recommended filesystem for **GW7** was **reiserfs** (http://www.novell.com/documentation/gw7/gw7_install/data/b3kipez.html#b77qw4a) and the recommended filesystem for **GW8** is **ext3** (http://www.novell.com/documentation/gw8/gw8_install/data/b3kipez.html#b77qw4a).

2.2.5 Method Considerations

Which of the various [tools](#) best meets your needs? Knowing which tools you will use is important to planning your upgrade strategy.

2.2.6 Network Considerations

Is the network functioning optimally, or do you need to make changes before you upgrade?

Are required ports available?

Make sure that services such as DNS, DHCP, and SLP are optimally configured and in good working order. This is critical for all installations and upgrades.

2.2.7 eDirectory/LDAP Considerations

Is the eDirectory partition and replication layout optimal:

- ◆ Where are the replica rings located?
- ◆ Which servers have partitions on them?
- ◆ Where do you want replication rings and partitions to be after you finish your upgrade to OES?

If you fail to plan properly in this area, you can count on running into network replication problems. Refer to the *Novell eDirectory 8.8 Administration Guide*, particularly “[Designing Your Novell eDirectory Network](#)” for detailed information.

- ◆ If your current eDirectory tree structure doesn't meet your needs, is it time to redesign it?

Novell recommends implementing multiple LDAP servers because of the critical nature of the LDAP service. LDAP servers should be fronted with an L4 switch for load sharing and redundancy. If an L4 switch is not available, then DNS round-robin could be used as an alternative.

2.2.8 Time Synchronization

Is time synchronization on your network in order?

- ♦ Are all NetWare virtual machines using Timesync rather than NTP?
- ♦ Is the TCP/IP protocol is loaded on any physical NetWare servers that use NTP?
- ♦ Is only one server used as the *ultimate* time source?

NTP uses a time provider group in which all servers in a geographical network obtain time from other servers in the same network. Only one network server should communicate with a server outside the network in order to keep traffic across routers and WANs at a minimum.

To understand time synchronization requirements and possibilities in an OES 2 network, see “Time Services” in the *OES 2 SP3: Planning and Implementation Guide*.

2.2.9 Cluster Considerations

If clusters are part of your plan, how will your cluster environment impact your efforts to upgrade to OES?

- ♦ What is the primary role of your cluster (GroupWise high availability, file and print services, directory services)?
- ♦ Do you need to consider splitting large clusters into multiple smaller clusters, one for each service?

By separating clusters this way, problems in one service cluster won't spill over and potentially affect other clustered services.

Splitting your clusters can also simplify administration efforts, because you can independently manage each cluster. Also, if you need to do a cluster update, a rolling upgrade of a six-node cluster is much easier than a rolling upgrade of a 32-node cluster.

- ♦ Are you planning to implement Novell Business Continuity Clustering to allow automated management of site-to-site failovers? If so, how will this affect your efforts and will your network topology be affected? Business Continuity Clustering lets you define which of your resources are considered “vital,” so only those services move to an off-site location rather than the entire cluster.
- ♦ Will a rolling upgrade help you upgrade your clustered services?

Refer to the “[Upgrading OES 2 Clusters \(Rolling Cluster Upgrade\)](#)” in the *OES 2 SP3: Novell Cluster Services 1.8.8 Administration Guide for Linux* for detailed information.

2.2.10 Application Compatibility Considerations

What applications are currently hosted on your NetWare servers? Are comparable Linux applications available and are they certified for OES 2 or SLES 10?

Because of the multitude of applications being used by our customers, it is impossible for Novell to make recommendations in every instance, so you might need to contact the vendor directly. But first check the [Novell Partner Products site \(http://www.novell.com/partnerguides/section/677.html\)](http://www.novell.com/partnerguides/section/677.html) for the latest certifications.

2.2.11 LAN/WAN Connection Considerations

Is the performance of all of your WAN links within acceptable limits? Are there any indications of systemic problems? Are all replica rings maintaining proper synchronization?

It is essential that all of your LAN/WAN connections be performing within the expected parameters before you begin your upgrade to OES.

3 Upgrading eDirectory to OES

This section discusses upgrading eDirectory™ to OES 2 and includes the following sections:

- ♦ [Section 3.1, “About eDirectory in OES 2,” on page 33](#)
- ♦ [Section 3.2, “Planning Your eDirectory Upgrade,” on page 36](#)
- ♦ [Section 3.3, “Upgrading eDirectory,” on page 40](#)
- ♦ [Section 3.4, “Post-Upgrade Checks,” on page 42](#)
- ♦ [Section 3.5, “About Domain Services for Windows,” on page 42](#)
- ♦ [Section 3.6, “Additional eDirectory Resources,” on page 45](#)

3.1 About eDirectory in OES 2

- ♦ [Section 3.1.1, “The Role of eDirectory in OES 2,” on page 33](#)
- ♦ [Section 3.1.2, “eDirectory Version Considerations,” on page 34](#)
- ♦ [Section 3.1.3, “About eDirectory Management Tools in OES 2,” on page 35](#)

3.1.1 The Role of eDirectory in OES 2

- ♦ [“eDirectory Is Essential to OES 2 Services” on page 33](#)
- ♦ [“About Installing eDirectory and OES Services” on page 34](#)
- ♦ [“The First Server Is Critical” on page 34](#)
- ♦ [“eDirectory Provides Additional Security for the Server” on page 34](#)

eDirectory Is Essential to OES 2 Services

eDirectory is an integral component of the services that make up OES 2. As with NetWare®, service users are created as User objects in eDirectory and authenticate to gain service access.

OES servers exist as Server objects and there are numerous other objects and configurations stored “behind the scenes” in eDirectory that work together to deliver the same functionality that people are accustomed to with NetWare.

eDirectory even provides eDirectory users with access to some services that would normally require the creation of local user accounts on the server itself.

About Installing eDirectory and OES Services

During the install, when you reach the software selections screens, none of the OES services is selected by default.

You can specifically select eDirectory for installation, or, if you select a service that requires eDirectory, eDirectory is automatically selected for installation.

If you are installing into an existing eDirectory tree and you don't want eDirectory installed on the server, you can deselect it.

When you configure the services that require eDirectory, you enter the information for an eDirectory server in the tree (either the server you are installing or an existing server), including the name, context, and password of an administrative user with rights to install the required objects in the tree.

The First Server Is Critical

If you are creating a new eDirectory tree on your network, the first server you install is important for two reasons:

- ◆ The basic eDirectory tree structure is created during the first installation.
- ◆ The first server permanently hosts the Certificate Authority for your organization.

eDirectory Provides Additional Security for the Server

When you install eDirectory on a server, the server is configured by default to use eDirectory certificates for HTTPS services, providing a significantly enhanced level of security for the server.

For more information, see “[Certificate Management](#)” in the *OES 2 SP3: Planning and Implementation Guide*.

3.1.2 eDirectory Version Considerations

Novell® recommends that all servers in a tree be of the same fully supported eDirectory and OS versions.

- ◆ “[eDirectory 8.8.6](#)” on page 34
- ◆ “[eDirectory 8.7.3 on NetWare 6.5 SP8](#)” on page 35
- ◆ “[Migrating Earlier DS Versions](#)” on page 35

eDirectory 8.8.6

OES 2 SP3 includes eDirectory 8.8.6. Where possible, you should upgrade existing servers to eDirectory 8.8.6 before or during the process of introducing OES 2 SP3 into the environment.

For complete information, refer to the *Novell eDirectory 8.8 What's New Guide* available at www.novell.com/documentation/edir88 (<http://www.novell.com/documentation/edir88/>).

eDirectory 8.7.3 on NetWare 6.5 SP8

Novell supports eDirectory 8.7.3.9 or later on NetWare to facilitate the transition from NetWare to OES 2. Although they have somewhat different feature sets, these two versions of eDirectory are tested and certified to inter-operate within the same tree.

eDirectory must be hosted on a current fully supported OS. At this time, the only version of NetWare that is under support (limited) is NetWare 6.5.

Migrating Earlier DS Versions

Earlier versions of DS/eDirectory should be migrated to eDirectory 8.7.3.7 as outlined in [Table 1-1, "Upgrade Paths from Earlier Versions of NetWare,"](#) on page 12.

3.1.3 About eDirectory Management Tools in OES 2

Several tools, many of them Web-based, can be used to manage aspects of eDirectory. The primary tools are listed here.

- ♦ **iManager 2.7:** A browser-based tool that lets you set up and manage your Novell eDirectory tree; manage eDirectory objects, schema, partitions, and replicas; and create and manage users, groups, and other objects. For more information, see [Novell iManager 2.7.4 Administration Guide](#).
- ♦ **iMonitor:** A browser-based tool that provides cross-platform monitoring and diagnostic capability for all servers in an eDirectory tree. For more information, see ["Using Novell iMonitor 2.4"](#) in the [Novell eDirectory 8.8 Administration Guide](#).
- ♦ **Novell Remote Manager for OES:** A browser-based utility for monitoring server health, changing the server configuration, or performing diagnostic and debugging tasks. Novell Remote Manager (NRM) provides functionality that is not available in other management utilities. For information, see the [OES 2 SP3: Novell Remote Manager for Linux Administration Guide](#).
- ♦ **Novell Import Conversion Export Utility (ICE):** You use ICE to:
 - ♦ Import data from LDIF files to an LDAP directory
 - ♦ Export data from the LDAP directory to an LDIF file
 - ♦ Move data between LDAP servers
 - ♦ Perform a schema compare and update
 - ♦ Load information into eDirectory by using a template
 - ♦ Import schema from SCH files to an LDAP directory

For more information, see ["Novell Import Conversion Export Utility"](#) in the [Novell eDirectory 8.8 Administration Guide](#).

- ♦ **DSBK:** This is a thin command line parser that performs the same operations as the Backup eMTool, but it lets you initiate a backup from the server console without logging in first or setting up Role-Based Services.

For more information, see ["Using DSBK "](#) in the [Novell eDirectory 8.8 Administration Guide](#).

- ♦ **eDirectory Management Toolbox (eMBox):** Lets you access all of the eDirectory back-end utilities remotely or on the server and works with Novell iManager to provide Web-based access to eDirectory utilities such as DSRepair, DSMerge, and Service Manager.

For more information, see ["The eDirectory Management Toolbox"](#) in the [Novell eDirectory 8.8 Administration Guide](#).

- ♦ **Terminal Prompt Configuration Tools.** The following tools are also available:
 - ♦ **ndsconfig:** Lets you configure eDirectory, add an eDirectory replica server to an existing tree, or create a new tree. For usage information, enter `man ndsconfig` at the terminal prompt.
 - ♦ **ldapconfig:** On OES servers, only use this when explicitly instructed to in the OES-specific documentation.
 - ♦ **nmasinst:** Lets you configure Novell Modular Authentication Service (NMASTM) and install login methods. For usage information, enter `man nmasinst` at the terminal prompt.
 - ♦ **General Utilities.** Refer to “Novell eDirectory Linux and UNIX Commands and Usage” in the *Novell eDirectory 8.8 Administration Guide* for a list and description of command line tools along with syntax, and refer to “LDAP-Specific Commands” for LDAP-specific commands.
- ♦ **ConsoleOne:** This utility is not supported to perform administration tasks on OES 2 server. However, if you have a service that requires ConsoleOne®, such as Novell GroupWise®, it is supported for administration of those applications.

3.2 Planning Your eDirectory Upgrade

Installing eDirectory on OES 2 provides an excellent opportunity to review your current directory structure to ensure that it meets your organization's needs and growth patterns.

- ♦ [Section 3.2.1, “Deciding Whether to Redesign Your Tree,” on page 36](#)
- ♦ [Section 3.2.2, “Checking eDirectory Health,” on page 38](#)
- ♦ [Section 3.2.3, “For More Information,” on page 40](#)

3.2.1 Deciding Whether to Redesign Your Tree

Upgrading to OES 2 provides an excellent opportunity to evaluate whether changes are necessary to better accommodate your current and future needs.

- ♦ [“Questions to Ask” on page 36](#)
- ♦ [“Deciding Whether to Move Services” on page 37](#)
- ♦ [“For File and Print, Design around Your WAN” on page 37](#)
- ♦ [“Verify Your Redesign in a Lab First” on page 37](#)

Questions to Ask

- ♦ **Type of Tree:** Does a Traditional (pyramid-shaped, single tree environment) or specialized tree (flat tree designed for a specific situation such as an identity vault or LDAP authentication) make better sense in your environment? Many Novell customers are opting for a flat tree so LDAP can walk the tree more efficiently to find a user object.
- ♦ **Physical Network Layout—Location-based and Designed Around WAN links):** Analyze the number of offices, where they are located, how many users are at each site, how sites communicate with each other, whether offices share the same data, and how data is routed among the sites.
- ♦ **Organizational Structure—Function-based Design):** Is your organization static or dynamic? What growth patterns do you anticipate?
- ♦ **Security:** How secure does your data need to be? Does some data need enhanced security?

- ♦ **Server configuration:** What types of servers are on your network? Do they need to interact? Where are they located? What applications and services does each host? Are they managed locally or centrally?
- ♦ **User accessibility needs:** Which applications and services are needed by which users? Do users need to read data or modify it? Which rights need to flow from the root? How many users need remote access? Where will remote users access data from?
- ♦ **Application needs:** Which offices use the same applications? How many users are there per application? Are applications installed locally or centrally?
- ♦ **Administrative strategies:** Do you intend to manage eDirectory centrally or from many dispersed locations?
- ♦ **Naming standards for eDirectory objects:** What naming standards are in force? Do any of them need to be changed or updated?
- ♦ **Scalability and interoperability:** How important are these on your network? Are you willing to compromise scalability and/or performance for other worthwhile goals?
- ♦ **Speed and efficiency:** How important are these on your network? Are you willing to compromise speed and efficiency for other worthwhile goals?
- ♦ **Fault tolerance:** What steps have you taken to provide fault tolerance? Do additional options need to be implemented?

Deciding Whether to Move Services

If you decide to redesign your system, you need to determine whether to keep services in their original tree or move them to a new tree. As part of this process, you probably also want to remove any objects that are no longer being used.

For File and Print, Design around Your WAN

It is important that the WAN configuration is the first and foremost consideration for designing any eDirectory tree that caters primarily to file and print, particularly if your organization includes several remote facilities. In most cases, you should provide a partition for each remote location, even when it is a single-server site.

For example, if you plan to have five OES 2 servers in place that are primarily dedicated to providing eDirectory replica services, all of the Master replicas could be contained on one of these servers along with multiple replicas of the higher levels of the tree. Each remote server should include an R/W replica of its local partition. Make sure you have three writable replicas in place to provide adequate redundancy.

Verify Your Redesign in a Lab First

If you decide to re-engineer your tree, it's a good idea to create the new tree in a lab to make sure you can work with its structure and that it's actually going to work the way you want before you put it into production.

3.2.2 Checking eDirectory Health

Problems with eDirectory can derail a rollout very quickly. Make sure there are no significant health issues before you begin the upgrade. Determine whether the prerequisites have been met for introducing OES 2 and eDirectory 8.8 into an existing tree or for transferring eDirectory from NetWare to OES.

- ♦ “What to Check For” on page 38
- ♦ “Health Check Tools To Use” on page 39
- ♦ “Check Requirements, Prerequisites, and Compatibility” on page 39
- ♦ “Check Application Compatibility” on page 39

What to Check For

NOTE: When you upgrade to eDirectory 8.8, a server health check is conducted by default to ensure that the server is safe for the upgrade.

Whichever option you choose, make sure each of the following is checked:

- ♦ **eDirectory Version:** Running different versions of NDS® or eDirectory on the same version of NetWare can cause synchronization problems. All NDS versions should be at the latest version on their respective operating system platforms. If your version of NDS or eDirectory is outdated, download the latest software patch from [Novell Directory Services Patches and Files \(http://support.novell.com/patches.html\)](http://support.novell.com/patches.html).
- ♦ **Time Synchronization:** NDS communication uses time stamps to uniquely identify objects and the object's modification time for synchronization purposes. Time stamps are assigned to each object and property to ensure the correct order for object and property updates. If servers in the tree are not synchronized to the correct local time (or more importantly, to each other) replica synchronization is not reliable and severe object corruption and data loss can be experienced. To avoid these problems, time needs to be in sync across all servers in the network.
- ♦ **Server-to-Server Synchronization:** NDS servers communicate changes made to objects and partition boundaries. This step verifies that no errors exist when NDS performs synchronization processes.
- ♦ **Replica Ring Synchronization:** This operation reads the Synchronization Status attribute from the replica object on each server that holds replicas of the partitions. It displays the time of the last successful synchronization to all servers as well as any errors that have occurred since.
- ♦ **Synchronization Tolerances:** This operation indicates the time periods since a server has synced with inbound and outbound data changes, how much data is outstanding, etc.
- ♦ **Background Processes:** These processes perform a variety of tasks, including replication of changes and maintenance of system information.
- ♦ **External References:** This check determines whether a replica containing the object can be located.
- ♦ **Stuck Obituaries:** These are object delete and move operations that have not completed successfully because mixed versions of DS have been used. Significant overhead is expended by the replica servers in retrying the obituary process constantly without success. Check the Flag States of the obituaries on all servers in the backlink lists for the obituaries.
 - ♦ **Collision and Unknown Objects:** In most cases, these objects can be deleted, but each should be investigated for origin and references first.
 - ♦ **Replica States:** Check the partitions and states of the replicas stored in the server's NDS database files.

- ♦ **eDirectory Schema Synchronization:** Each NDS server has schema definitions that are used for creating and maintaining objects. Verify that schema synchronization between servers is working correctly.

Health Check Tools To Use

Depending on your preference, you can perform an eDirectory server health check in several ways:

- ♦ **Use the health check utilities in eDirectory 8.8:** Novell eDirectory 8.8 runs a health check by default with every upgrade before the actual package upgrade.
 - ♦ OES health checks are run by default before an upgrade operation starts.
 - ♦ NetWare health checks happen as part of the installation wizard.

You can run the diagnostic tools (`ndscheck` on OES 2; `dscheck` on NetWare), to complete a health check at anytime.

For additional information, including command parameters for each operating system, refer to “eDirectory Health Checks” in the *Novell eDirectory 8.8 Installation Guide*.

- ♦ **Use iMonitor:** You can use either of two methods (manual and automated) in iMonitor, a web-based diagnostic tool:
 - ♦ Use the Navigator Frame (*iMonitor > Navigator > Reports*).
 - ♦ Use the Assistant Frame (*iMonitor > Assistant > Agent Health*).

Even with a large number of servers, this procedure tends to run very quickly (less than 5 minutes for 15-20 servers if all of the servers are healthy). The process is the same for all operating systems.

- ♦ **Use TID 10060600:** You can view a tutorial or access a text version of the TID at <http://support.novell.com/additional/tutorials/index.html> (<http://support.novell.com/additional/tutorials/index.html>)

Check Requirements, Prerequisites, and Compatibility

For system requirements and prerequisites, see *Installing or Upgrading Novell eDirectory on Linux* in the *Novell eDirectory 8.8 Installation Guide* for a complete listing and explanation.

Check Application Compatibility

Check currently installed Novell and third-party applications to determine if eDirectory 8.8 is supported before upgrading your existing eDirectory environment. You can find the current status for Novell products in TID 31714342 “What Novell products are supported with Novell eDirectory 8.8” (http://www.novell.com/support/php/search.do?cmd=displayKC&docType=kc&externalId=3171434&sliceId=1&docTypeID=DT_TID_1_1&dialogID=48117155&stateId=0%200%2048113961)

If a product is not supported:

- ♦ Do not install eDirectory 8.8 on the same server as the product.
- ♦ Do not configure the product to search an eDirectory 8.8 server.

As long as these conditions are met, you can still upgrade unaffected servers and services to OES 2 and eDirectory 8.8 and run with a mixed tree until a replacement for the older application is found.

3.2.3 For More Information

For additional eDirectory design information, refer to “[Designing Your Novell eDirectory Network](#)” in the *Novell eDirectory 8.8 Administration Guide*.

3.3 Upgrading eDirectory

Use the information in the following sections to ensure a smooth eDirectory upgrade in connection with upgrading NetWare to OES.

- ♦ [Section 3.3.1, “Do Not Install or Upgrade to eDirectory 8.8 Separately from OES 2,”](#) on page 40
- ♦ [Section 3.3.2, “Choosing an Upgrade Strategy,”](#) on page 40
- ♦ [Section 3.3.3, “Moving, Creating, or Importing eDirectory Users,”](#) on page 41

3.3.1 Do Not Install or Upgrade to eDirectory 8.8 Separately from OES 2

Because OES services are tightly integrated with eDirectory, both the services and eDirectory must be upgraded at the same time. The OES 2 install is not designed to handle a separate installation or upgrade of eDirectory 8.8.

3.3.2 Choosing an Upgrade Strategy

There are several basic strategies for setting up eDirectory on OES 2 or upgrading to the OES 2 platform:

- ♦ [“Transferring eDirectory to a New Server”](#) on page 40
- ♦ [“Starting Fresh with OES 2”](#) on page 40
- ♦ [“Adding a branch to an existing tree”](#) on page 41
- ♦ [“Manual Upgrade Using Replicas”](#) on page 41

Transferring eDirectory to a New Server

If your current tree is meeting your needs, the simplest upgrade method is to transfer an existing NetWare server to a new OES 2 server.

Use the OES 2 SP3 Migration Tool for this purpose, specifically the Identity Transfer functionality. For more information, see [“Transfer ID Migration”](#) in the *OES 2 SP3: Migration Tool Administration Guide*.

Starting Fresh with OES 2

This is a good choice if you are unhappy with your existing tree (the tree hasn't kept up with organizational changes and growth). Moving to OES 2 provides an opportunity to update the tree by starting from scratch. You might consider consolidating more services while adding new OES servers. Some Novell customers have incorporated specialty trees, such as an identity vault on SLES 10 rather than on OES 2.

In cases where eDirectory or the operating system and services are outdated, it sometimes makes sense to just redo the whole environment (new tree design, partitioning, replication strategies, newer utilities/services) rather than port the existing structure.

The single biggest issue in many organizations is that NetWare and eDirectory haven't been patched, so starting fresh is the easier option. This is true of file and print as well. Most customers who use this strategy are moving to OES 2 from NetWare 5 and NDS 6 (which is limited to 1500 users).

Adding a branch to an existing tree

Some Novell customers transfer objects to a new OES 2 branch and then gradually retire the older NetWare branch. By adding a branch, it's easier to drag and drop users and login scripts, certificates, and PKI so they don't need to be re-created.

Manual Upgrade Using Replicas

If all you want to do is copy the existing eDirectory information from a NetWare server to a new OES 2 server, without the OES server assuming the NetWare server's identity, you can move objects to a new OES 2 branch and then gradually retire the older NetWare branch. When you've added a branch, it's easy to drag and drop users and login scripts, certificates, and PKI so they don't need to be re-created.

- 1 Create a new OES 2 server with a new eDirectory 8.8 tree.
- 2 Create an eDirectory replica on the target OES server by attaching it to the same replica ring as the source NetWare server.

This creates two instances of eDirectory in the environment. The OES Migration Tool does a non-destructive move of all services, and it needs both servers with their respective directories up and running.

- 3 Allow the OES eDirectory installation to synchronize.

If necessary, you can rework the layout of your tree structure, remap the location of all user objects in your new tree, and delete any user objects that are no longer needed.

- 4 When eDirectory synchronization of the replica is complete, move the impacted services with the OES 2 SP3 Migration Tool.
- 5 Retire the older NetWare server.

Except where dependencies exist, there is no required order for moving services in the same tree. An example of a dependency would be that the Archive and Versioning service depends on the file system.

3.3.3 Moving, Creating, or Importing eDirectory Users

If you have opted to create a new tree, you need to decide how to move user objects from one tree to another. Several options are available:

- ♦ [“Using Novell Identity Manager” on page 41](#)
- ♦ [“Creating and Importing an LDIF file” on page 42](#)
- ♦ [“Using the OES 2 Migration Tool” on page 42](#)

Using Novell Identity Manager

One method is setting up a Novell Identity Manager connection between your old tree and your new one. This lets you easily synchronize user objects to the new tree. You can also use Identity Manager to remap the location of all user objects in your new tree.

Creating and Importing an LDIF file

Create an LDIF file containing user objects and use iManager to import it. Configure the LDIF file so it creates a Users' organization container and then places an object for each user in it.

IMPORTANT: Replica and partition information cannot be imported by using an LDIF file.

Using the OES 2 Migration Tool

If you are creating a new tree, the Migration Tool can not only move the data but also create new users in the tree and match them to the data being moved. It can also match up users and trustees in the old tree with those in the new tree.

It is probably easiest to create the new users by using one of the other methods and then match them up through the Migration Tool.

3.4 Post-Upgrade Checks

Check to be sure that your upgraded tree is healthy, that the services are running correctly, and that services are usable by all network users as expected.

3.5 About Domain Services for Windows

NOTE: The following overview of DSfW is copied from the [OES 2 SP3: Planning and Implementation Guide](#) for your convenience.

Novell Domain Services for Windows (DSfW) allows eDirectory users on Windows workstations to access storage on both OES servers and Windows servers by using native Windows and Active Directory authentication and file service protocols.

DSfW enables companies with Active Directory and Novell eDirectory deployments to achieve better coexistence between the two platforms.

- ◆ Users can work in a pure Windows desktop environment and still take advantage of some OES back-end services and technology, without the need for a Novell Client™ or even a matching local user account on the Windows workstation.
- ◆ Network administrators can use either Microsoft* Management Console (MMC) or iManager to administer users and groups within the DSfW domain, including their access rights to Samba-enabled storage on OES servers.

Figure 3-1 DSfW File Access Overview

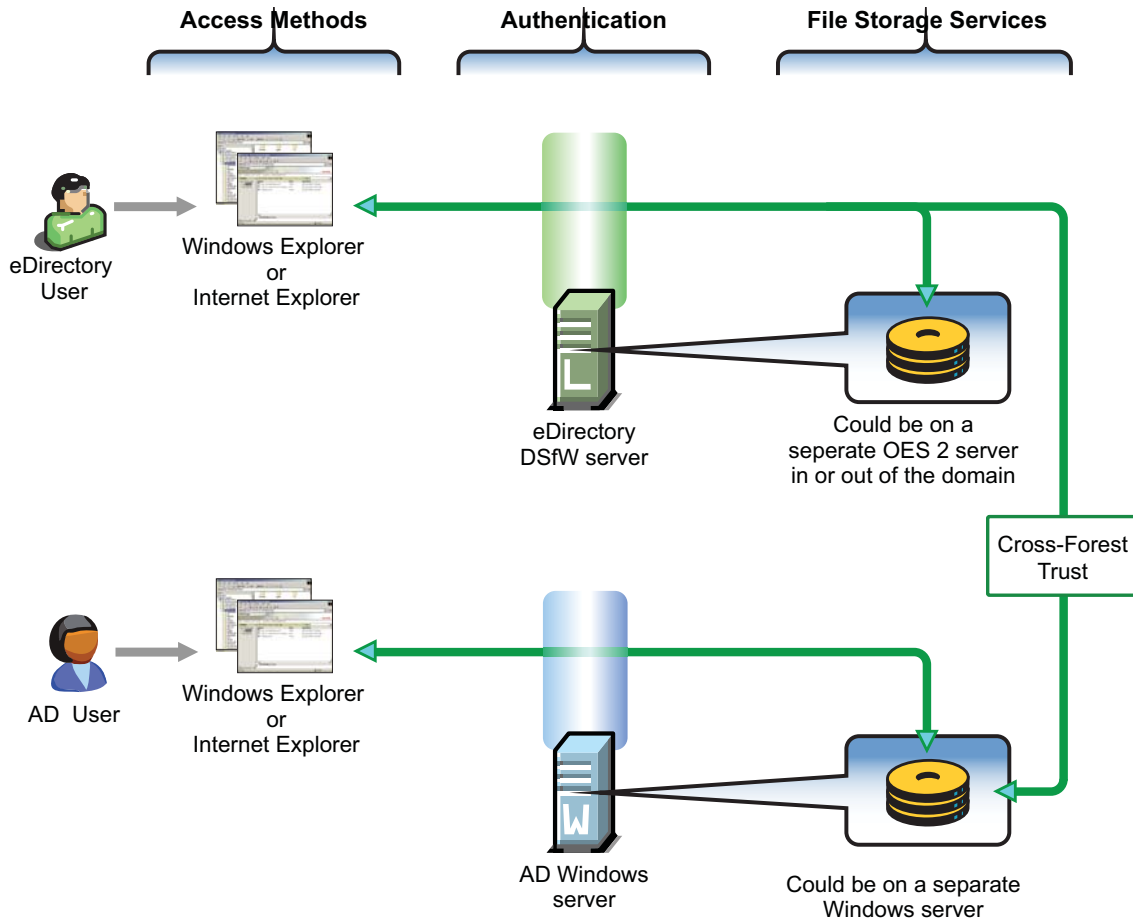

The following table explains the information illustrated in [Figure 3-1](#).

Access Methods	Authentication	File Storage Services
<p>eDirectory and Active Directory users on Windows workstations can access files through Windows Explorer* (CIFS) or Internet Explorer (WebDAV Web Folders). No Novell Client can be on the machine.</p> <p>Unlike Windows workgroup or Novell Samba, the user doesn't need to have a matching username and password on the local workstation.</p> <p>Although not shown, Novell Client users can also access files through a normal NCP™ connection.</p>	<p>For eDirectory users, file service access is controlled by authentication through the eDirectory server, using common Windows authentication protocols, including Kerberos*, NTLM, and SSL/TLS.</p> <p>For AD users, file service access is controlled by authentication through the AD server.</p>	<p>On OES 2 servers, file storage services are provided by Samba to NSS or traditional Linux file systems.</p> <p>For eDirectory users, access to storage on Windows servers is available through a cross-forest trust. Access rights are granted by the AD administrator following the establishment of the cross-forest trust.</p>

Figure 3-2 DSfW User Management Overview

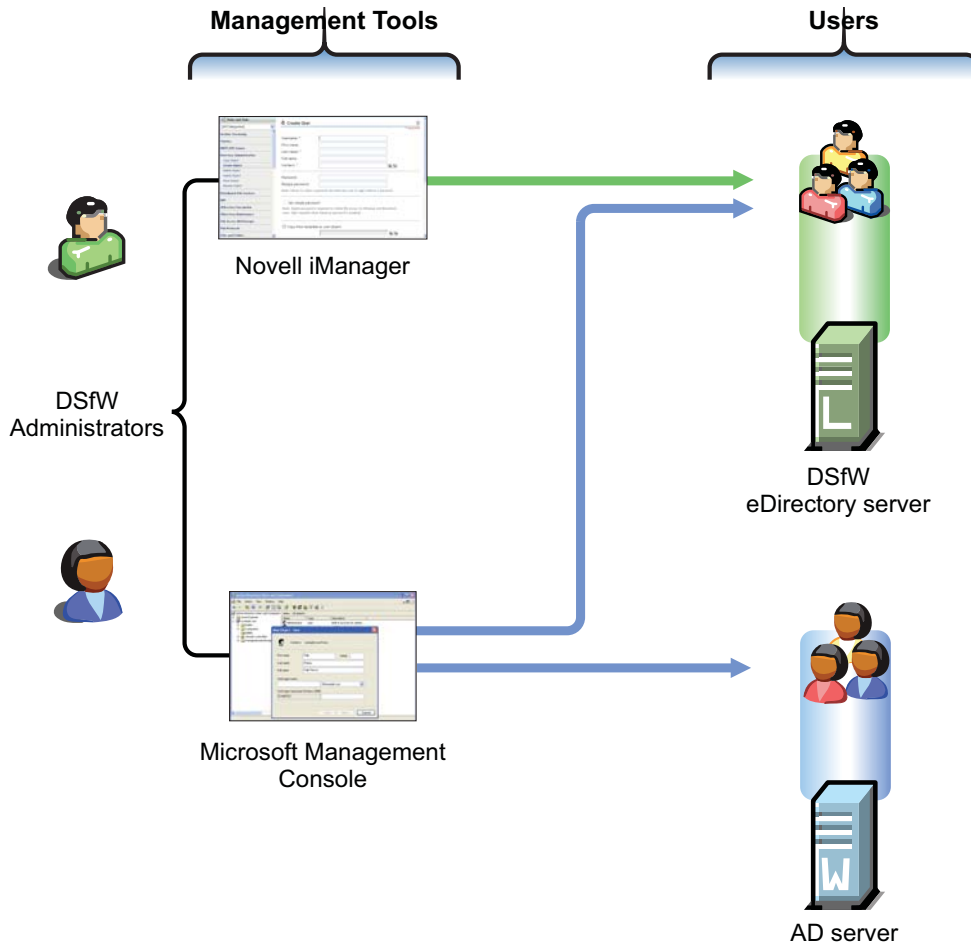

The following table explains the information illustrated in [Figure 3-2](#).

Management Tools	Users
iManager manages DSfW users exactly like other eDirectory users.	DSfW users must have the Default Domain Password policy assigned and a valid Universal Password.
MMC manages both AD users and DSfW users as though they were AD users.	DSfW users are automatically enabled for Samba and LUM.

Figure 3-3 DSfW Storage Management Overview

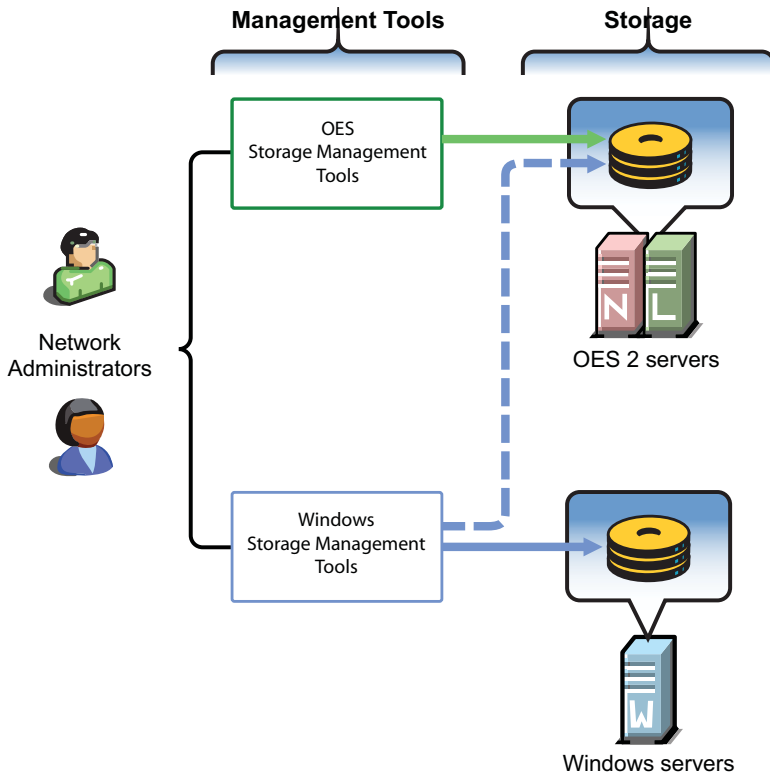

The following table explains the information illustrated in [Figure 3-3](#).

Management Tools	Storage
<p>Network administrators use native OES and Windows storage management tools to create and manage storage devices on OES and Windows servers, respectively.</p> <p>Windows management tools can also manage share access rights and POSIX* file system rights on DSfW storage devices after the shares are created. They cannot create the shares or perform other device management tasks.</p>	<p>Storage devices on OES 2 servers can be either NSS or traditional Linux volumes. Samba management standards apply to both volume types.</p>

For planning information, see the [OES 2 SP3: Domain Services for Windows Administration Guide](#).

For implementation information, see the [OES 2 SP3: Domain Services for Windows Administration Guide](#).

3.6 Additional eDirectory Resources

Click the following links to access additional eDirectory resources.

- ♦ [eDirectory 8.8 Documentation \(http://www.novell.com/documentation/edir88/\)](http://www.novell.com/documentation/edir88/)

- ◆ eDirectory Health Check - Online Tutorial (<http://support.novell.com/additional/tutorials/tid10060600/>)
- ◆ eDirectory Training Courses (<http://www.novell.com/training/courseware/catalog.jsp?pl=112>)

4 Upgrading NSS and Data Storage to OES

- ◆ [Section 4.1, “About NSS in OES 2,” on page 47](#)
- ◆ [Section 4.2, “Platform Differences in NSS,” on page 48](#)
- ◆ [Section 4.3, “Planning to Upgrade NSS,” on page 48](#)
- ◆ [Section 4.4, “Moving NSS and Data,” on page 50](#)
- ◆ [Section 4.5, “Post-Upgrade Procedures,” on page 51](#)
- ◆ [Section 4.6, “Upgrading Distributed File Services \(DFS\) to OES,” on page 52](#)

4.1 About NSS in OES 2

Novell® Storage Services™ is available with NetWare® 5.0 and later. The NSS kernel has been open sourced and is included in Novell SUSE® SLES 9 SP1 Linux distribution and later and with Novell OES 2. The tools to manage NSS are available only in OES.

- ◆ [Section 4.1.1, “NSS Is Designed for the Enterprise,” on page 47](#)
- ◆ [Section 4.1.2, “More Reasons to Consider NSS,” on page 47](#)

4.1.1 NSS Is Designed for the Enterprise

The NSS file system is unique in many ways, mostly in its ability to simultaneously manage and support shared file services from different file access protocols. It is designed to manage access control in enterprise file sharing environments.

One of its key features is the Novell Access Control Model, which securely scales to hundreds of thousands of users accessing the same storage. NSS and its predecessor (NWFS) are the only file systems that can restrict the visibility of the directory tree based on the user accessing the file system. Both NSS and NWFS have built-in ACL rights inheritance.

NSS includes mature and robust features tailored for the file sharing environment of the largest enterprises.

Dynamic Storage Technology works with NSS volumes on OES 2.

4.1.2 More Reasons to Consider NSS

Novell Storage Services is generally the best file system solution for customers transferring file sharing services from NetWare to OES. NSS file systems created on NetWare can be mounted on OES servers.

The following characteristics of NSS on OES 2 should be noted in your planning:

- ◆ NSS volumes are cross-compatible between OES and NetWare. NSS data volumes can be mounted on either NetWare or OES and the data can be moved between them.

- ◆ NSS devices and storage can be managed in the Web-based Novell iManager utility. NSS also supports third-party tools on both platforms for advanced data protection and management, virus scanning, and traditional archive and backup solutions.
- ◆ In a mixed-platform cluster with Novell Cluster Services™, NSS volumes can fail over between OES and NetWare, allowing for full data, trustee, and file system feature preservation when moving data to OES. However, best practice requires that you create all of the NSS volumes you need in the cluster on NetWare before you join any OES nodes to the cluster. After that point, you should not create additional NSS volumes or modify any of them until the cluster has only OES servers remaining.
- ◆ In addition, NSS on OES 2:
 - ◆ Retains all files, rights, metadata, restrictions, etc.
 - ◆ Includes NetWare Trustee access control (richer than POSIX)
 - ◆ Retains file system access (NCP™)
 - ◆ Retains all file system administration and management features
 - ◆ Can be easily clustered with Novell Cluster Services (NCS)
 - ◆ Is best for shared LAN file serving: excellent scalability in number of files; scales to millions of files in a single directory
 - ◆ Supports multiple data streams and rich metadata (its features are a superset of existing file systems on the market for data stream, metadata, namespace, and attribute support)
 - ◆ Is journaled

4.2 Platform Differences in NSS

Most NSS features that have been available on NetWare are now also available on OES 2.

For the most up-to-date feature comparison, see [“Comparison of NSS on NetWare and NSS on Linux”](#) in the *OES 2 SP3: NSS File System Administration Guide for Linux*.

4.3 Planning to Upgrade NSS

As you plan your NSS implementation, the following file system guidelines should be noted:

- ◆ [Section 4.3.1, “Identify NSS Coexistence and Migration Issues,”](#) on page 48
- ◆ [Section 4.3.2, “Limitations,”](#) on page 49

4.3.1 Identify NSS Coexistence and Migration Issues

For a complete discussion of the issues involved in the coexistence and migration of Novell Storage Services for OES 2 that might affect your planning, see the following sections in the *OES 2 SP3: NSS File System Administration Guide for Linux*:

- ◆ [“Cross-Platform Issues for NSS”](#)

Discusses pool snapshots, NSS volumes and features, file access, and management tools

- ◆ [“Migrating NSS Devices from NetWare 6.5 SP8 to OES 2 Linux”](#)

Includes guidelines for moving NSS pools and volumes between NetWare and OES 2 servers and instructions for moving both clustered and non-clustered devices from previous versions of NetWare and OES 1.

4.3.2 Limitations

- ♦ [“Traditional NetWare File System Is Not Supported”](#) on page 49
- ♦ [“Installing NSS on the System Disk”](#) on page 49
- ♦ [“Samba Access Requires LUM”](#) on page 49
- ♦ [“The Linux OS Can’t Be Installed on NSS”](#) on page 49
- ♦ [“Moving Volumes Cross-Platform Has Limitations”](#) on page 49
- ♦ [“Pool Snapshots Cannot Be Moved”](#) on page 50

Traditional NetWare File System Is Not Supported

The NetWare File System (NWFS) was used in NetWare 3.x through 5.x as the default file system, and is supported in NetWare 6.x for compatibility. It is one of the fastest file systems available; however, it does not scale and is not journaled. An Open Source version of this file system is available for Linux to allow access to its file data. However, the open source version lacks the identity management tie-ins, and therefore, has little utility.

NWFS is not supported on OES 2 and should, therefore, be moved—probably to the Novell Storage Services (NSS) file system.

Installing NSS on the System Disk

Novell recommends against including NSS on the system disk (the disk containing the `/boot` and `/` partitions) unless your server configuration requires it. If this is required, you must carefully follow the instructions in [“Installing with EVMS as the Volume Manager of the System Device”](#) in the *OES 2 SP3: Installation Guide*.

Samba Access Requires LUM

For a broad explanation of Linux User Management (LUM), see [“Linux User Management: Access to Linux for eDirectory Users”](#) in the *OES 2 SP3: Planning and Implementation Guide*. For information specific to NSS, see [“Planning NSS Storage Solutions”](#) in the *OES 2 SP3: NSS File System Administration Guide for Linux*.

The Linux OS Can’t Be Installed on NSS

You cannot install the Linux operating system on an NSS volume. OES 2 requires a Linux traditional file system volume for the operating system, such as Ext3, ReiserFS, or XFS.

Moving Volumes Cross-Platform Has Limitations

You can move an NSS volume that was created on NetWare cross-platform to an OES server. However, you should not move an NSS system (SYS:) volume from NetWare to OES unless you intend to use it as a data volume (or not at all) while it is mounted on the OES server.

If you move an NSS system pool cross-platform, any volumes it contains function as data volumes on the OES server, including the SYS: volume.

You can move storage devices containing NSS volumes between NetWare servers and OES 2 servers. When you move an unshared device to a different server, you must decommission its volumes in eDirectory for the current server, then recommission them for the new server. For shared NSS pools and volumes, Novell Cluster Services provides this service automatically.

NSS volumes that were originally created on NetWare can be moved cross-platform to an OES server. But only volumes that were originally created on NetWare can be moved back from OES to NetWare.

Pool Snapshots Cannot Be Moved

NSS pools that are a source pool or a destination pool for NSS pool snapshots on NetWare cannot move cross-platform if you want to keep the pool snapshots. A pool snapshot is no longer available if you move its source pool or destination pool to an OES server. The snapshot no longer works even after you move the pools back to NetWare.

Before you move an NSS pool cross-platform, make sure you delete any of its snapshots stored on other pools and any snapshots for other pools it might contain.

4.4 Moving NSS and Data

- ♦ [Section 4.4.1, “Moving NSS Devices Cross-Platform,” on page 50](#)
- ♦ [Section 4.4.2, “Moving Data from NSS on NetWare to NSS on OES 2,” on page 50](#)
- ♦ [Section 4.4.3, “Moving Data from NSS to Other Volume Types,” on page 51](#)

4.4.1 Moving NSS Devices Cross-Platform

This is arguably the simplest method of all. NSS supports moving devices containing NSS volumes between any servers that support a compatible media format, including moves between NetWare servers and OES 2 servers.

For instructions, see [“Moving Non-Clustered Devices From NetWare 6.5 SP8 Servers to OES 2 Linux Servers”](#) in the *OES 2 SP3: NSS File System Administration Guide for Linux* includes information on moving NSS volumes cross-platform between servers in the same Novell eDirectory tree. See also [“Cross-Platform Issues for NSS”](#).

4.4.2 Moving Data from NSS on NetWare to NSS on OES 2

The OES 2 SP3 Migration Tool supports transferring data from a source NSS volume on NetWare to a target NSS volume on OES 2. This method preserves both the Novell Trustee Rights for eDirectory users and the NSS directory and file attributes supported by only the NSS file system.

For more instructions, see [“Migrating File System from NetWare, OES 1 or OES 2 to OES 2 SP3 Linux”](#) in the *OES 2 SP3: Migration Tool Administration Guide*.

4.4.3 Moving Data from NSS to Other Volume Types

The OES 2 SP3 Migration Tool also supports moving data from an NSS volume on NetWare to a Linux POSIX volume on OES 2.

- ◆ If you configure the target Linux POSIX volume as an NCP volume and carefully follow the instructions, the Novell Trustee Rights are retained and only the NSS file and directory attributes are lost.
- ◆ If you move the data to a Linux POSIX volume target without configuring it as an NCP volume, the POSIX access model applies. eDirectory users must be enabled for Linux User Management to access data on Linux POSIX volumes.

If you are unsure about the implications briefly stated above, you should read the following sections in the OES 2 documentation:

- ◆ *OES 2 SP3: Planning and Implementation Guide*
 - ◆ “The Traditional Novell Access Control Model”
 - ◆ “NSS Access Control on OES”
 - ◆ “Novell Client (NCP File Services) Access”
 - ◆ “eDirectory User Access to OES 2 Servers”
- ◆ *OES 2 SP3: File Systems Management Guide*
 - ◆ “Understanding File System Access Control Using Trustees”
 - ◆ “Coexistence and Migration Issues”

4.5 Post-Upgrade Procedures

After files are transferred, file permissions might need to be reset. As discussed earlier, Linux file system permissions are different from and not as granular as those used by NetWare. This becomes especially apparent for directories where multiple groups previously had access to the data within a file. On Linux file systems, this is not possible, so an alternative must be found.

Novell recommends the following permissions as a starting point. You might need to change the permissions to better fit your needs.

Table 4-1 File Permissions Recommended for File Types

Type of files	Permissions:			
	user	group	other	numeric value
Home directories, such as <code>/home/userid</code>	rwX	---	---	700
User files, such as <code>/home/userid/myfile</code>	rw-	r--	---	740
Shared directory for a team (where the group is used for access.)	rwX	rwX	---	760
Shared team files (where the group is used for access.)	rw-	rw-	---	660

4.6 Upgrading Distributed File Services (DFS) to OES

The new DFS junction support on OES 2 brings the NetWare Novell Distributed File System feature set to Linux with the following additions:

- ◆ VLDB services are cluster-enabled.
- ◆ Junctions can point to subdirectories, not just the root of a volume.
- ◆ All administration is performed via iManager.
- ◆ Junctions can be created on any file system, not just Novell Storage Services.

Novell Distributed File Services (DFS) for the Novell Storage Services (NSS) file system provides location transparency of file data to end users. You can modify the underlying physical organization of data on NSS volumes to maximize the use and performance of available storage resources. With DFS, you can create a single virtual file system for data on NSS volumes that span multiple machines.

DFS preserves the logical file organization from the user perspective by maintaining a Volume Location Database (VLDB) for all volumes in a DFS management context. Using junctions and the VLDB eliminates the user's need to know the path to the physical location of the data.

For information and instructions, see [“Migrating DFS from NetWare to OES 2 Linux.”](#) in the *OES 2 SP3: Novell Distributed File Services Administration Guide for Linux*.

For additional instructions for moving NSS devices cross-platform, see [“Migrating NSS Devices from NetWare 6.5 SP8 to OES 2 Linux”](#) in the *OES 2 SP3: NSS File System Administration Guide for Linux*.

5 Upgrading File Services to OES

- ◆ Section 5.1, “Upgrading AFP File Services to OES,” on page 53
- ◆ Section 5.2, “Upgrading CIFS File Services to OES,” on page 57
- ◆ Section 5.3, “Upgrading Novell FTP to OES,” on page 61
- ◆ Section 5.4, “Upgrading iFolder to OES,” on page 62
- ◆ Section 5.5, “Upgrading NetWare Core Protocol (NCP) File Services,” on page 65
- ◆ Section 5.6, “Upgrading NetStorage,” on page 68

5.1 Upgrading AFP File Services to OES

- ◆ Section 5.1.1, “About AFP File Services in OES 2,” on page 53
- ◆ Section 5.1.2, “Platform Differences in AFP File Services,” on page 54
- ◆ Section 5.1.3, “Planning to Transfer AFP Services,” on page 56
- ◆ Section 5.1.4, “Upgrading AFP,” on page 56
- ◆ Section 5.1.5, “Post-Upgrade Checks,” on page 57

5.1.1 About AFP File Services in OES 2

Starting with OES 2 SP1, the AFP file services that were previously available only on NetWare® through the Native File Access Protocols (NFAP) service have now been ported to OES as Novell® AFP.

The Novell AFP service lets users on Macintosh workstations access and store files on OES 2 SP1 and later servers with NSS volumes without installing any additional software, such as the Novell Client™ (see [Figure 5-1](#)).

Figure 5-1 How Novell AFP Works

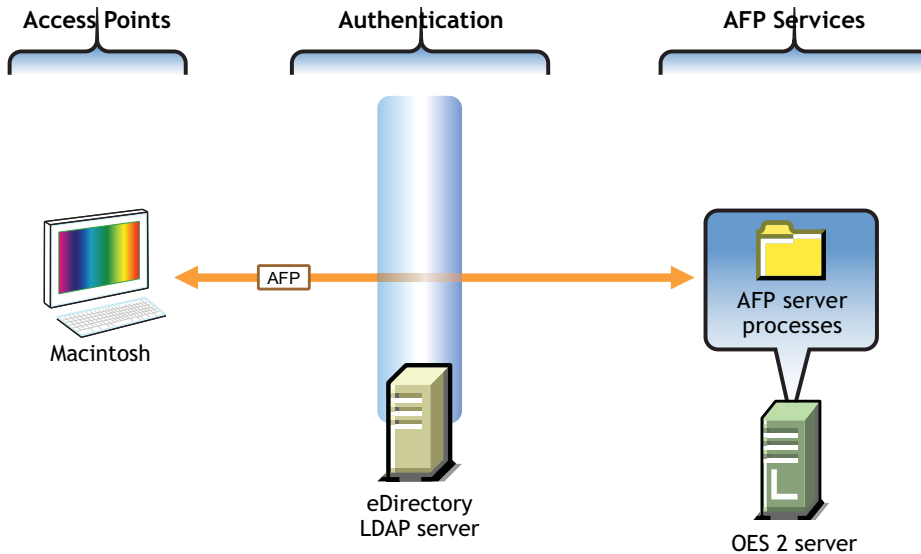

The following table explains the information illustrated in [Figure 5-1](#).

Access Points	Authentication	AFP File Services
eDirectory™ users on Macintosh workstations have native access to the OES 2 server.	All file service access is controlled by LDAP-based authentication through the eDirectory LDAP server. Although shown separately, eDirectory could be installed on the OES 2 server.	Of course, the same files can also be accessed through other OES file services (such as NetStorage) that connect to Linux volumes.

5.1.2 Platform Differences in AFP File Services

The differences in AFP services on NetWare and OES 2 are summarized in the following table.

Table 5-1 Platform Differences in AFP File Services

Feature Description	AFP for NetWare	AFP for OES
Administering	Limited to starting and stopping the server. See “Enabling and Disabling AFP” in the NW 6.5 SP8: AFP, CIFS, and NFS (NFAP) Administration Guide	Ability to configure AFP server parameters through iManager. See “Administering the AFP Server” in the OES 2 SP3: Novell AFP For Linux Administration Guide .

Feature Description	AFP for NetWare	AFP for OES
Filenames and Paths	<p>sys:\etc\ctxs.cfg</p> <p>sys:\etc\afpvols.cfg</p> <p>sys:\etc\afptcp.log</p>	<p>/etc/opt/novell/afptcpd/afpdirxxt.conf</p> <p>/etc/opt/novell/afptcpd/afpvols.conf</p> <p>/etc/opt/novell/afptcpd/afptcpd.conf</p> <p>/var/log/afptcpd/afptcp.log</p>
Installation	<p>Customized installation during installation of NetWare 6.5.</p> <p>See, “Installing Novell Native File Access Protocols on a NetWare 6.5 Server” in the <i>NW 6.5 SP8: AFP, CIFS, and NFS (NFAP) Administration Guide</i></p>	<p>Installation through YaST along with associated dependencies.</p> <p>See “Installing and Setting Up AFP” in the <i>OES 2 SP3: Novell AFP For Linux Administration Guide</i>.</p>
Simple Password support	Yes	No
Universal Password	Yes. Limited to 8 characters.	Yes. Over 8 characters.
Upgrade/migration support	Not Applicable	<p>Support to upgrade AFP from NetWare to OES.</p> <p>See “Migrating AFP from NetWare to OES 2 SP3 Linux” in the <i>OES 2 SP3: Novell AFP For Linux Administration Guide</i>.</p>
Mac versions supported	Classic Mac, Mac OS* 10.3, 10.4 and 10.5	Mac OS 10.3, 10.4 and 10.5
Cross-protocol locking	Supported among AFP, CIFS, and NCP™.	Supported among AFP, CIFS, and NCP.
Authentication methods	Clear text	<p>Clear text</p> <p>Two-Way Random Key Exchange</p> <p>Random Exchange</p> <p>Diffie-Hellman Exchange</p>
Dynamic detection of volumes	Yes	Yes, but the AFP server needs to be reloaded.
Choosing volumes to be exported	Yes	No. Exports all the volumes.
Support for 64-bit architecture	No	Yes

5.1.3 Planning to Transfer AFP Services

The OES 2 SP3 Migration Tool supports transferring AFP file services from NetWare to OES 2 SP3. The process is quite straightforward, but there are, of course, some planning steps that you must take to ensure a successful upgrade.

- ♦ [“Requirements” on page 56](#)
- ♦ [“Limitations” on page 56](#)
- ♦ [“Universal Password” on page 56](#)

Requirements

Table 5-2 AFP Source and Target Server Requirements

Source Server	Target Server
NetWare 5.1 or later	OES 2 SP3 The Novell AFP service pattern is installed but not configured. Data can be moved independently of the service. Users can always see what they have rights to see.

Limitations

The OES 2 SP3 Migration Tool does not support transferring AFP services across eDirectory trees. However, AFP services can be effectively transferred by first moving the data to an OES 2 SP3 target server in the other tree, and then configuring AFP on the target server.

For details, see [“Migrating Data to a Server in a Different Tree”](#) in the *OES 2 SP3: Migration Tool Administration Guide* and [“Installing and Setting Up AFP”](#) in the *OES 2 SP3: Novell AFP For Linux Administration Guide*.

Universal Password

Although Simple Passwords were an option with AFP on Netware, Novell AFP requires Universal Password, as listed in [Section 5.1.2, “Platform Differences in AFP File Services,” on page 54](#).

The process of upgrading AFP services to OES ensures that a Universal Password policy is assigned to all of the eDirectory contexts listed for AFP users on the NetWare server. If users currently have a Universal Password policy assigned, the tool checks for compliance with AFP requirements and modifies the policy if required.

5.1.4 Upgrading AFP

You can use either of the two migration types offered by the Migration Tool to transfer AFP file services from NetWare to OES 2:

- ♦ **Consolidate:** If you are transferring just the AFP service and associated data to an OES 2 SP3 server, you should perform a consolidation migration. For more information, see [Section A.1.1, “Consolidating Selected Data or Services,” on page 101](#).

- ♦ **Transfer ID:** If you are transferring an entire NetWare server, including the AFP service and associated data, to an OES 2 SP3 server, you should transfer the entire server configuration. For more information, see [Section A.1.2, “Transferring an Entire NetWare Server,”](#) on page 102.

To transfer Novell AFP from NetWare to OES 2, follow the instructions in [“Migrating AFP from NetWare to OES 2 SP3 Linux”](#) in the *OES 2 SP3: Migration Tool Administration Guide*.

5.1.5 Post-Upgrade Checks

- ♦ [“Verify Upgrade Success”](#) on page 57
- ♦ [“Preparing for the First Login”](#) on page 57

Verify Upgrade Success

After the process is complete, be sure to complete the instructions in [“Verifying the Migration Process”](#) in the *OES 2 SP3: Migration Tool Administration Guide*.

Preparing for the First Login

You must do two things to ensure that users can authenticate seamlessly to the transferred AFP service:

1. Restart eDirectory with the environment variable `NDS_TRY_NDSLOGIN_FIRST` set to `TRUE`.
2. Make sure that each user logs in for the first time by using either the Diffie-Hellman Exchange or clear-text authentication method.

For more information, see [“Cross-Platform Issues”](#) in the *OES 2 SP3: Migration Tool Administration Guide*.

5.2 Upgrading CIFS File Services to OES

- ♦ [Section 5.2.1, “About CIFS File Services in OES 2,”](#) on page 57
- ♦ [Section 5.2.2, “Platform Differences in CIFS File Services,”](#) on page 58
- ♦ [Section 5.2.3, “Planning to Upgrade CIFS Services,”](#) on page 59
- ♦ [Section 5.2.4, “Upgrading CIFS,”](#) on page 60
- ♦ [Section 5.2.5, “Post-Upgrade Checks,”](#) on page 61

5.2.1 About CIFS File Services in OES 2

Starting with OES 2, the CIFS file services that were previously available only on NetWare through the Native File Access Protocols (NFAP) service have now been ported to OES as Novell CIFS.

The Novell CIFS service lets users on Windows workstations access and store files on OES 2 servers with NSS volumes without installing any additional software, such as the Novell Client (see [Figure 5-2](#)).

Figure 5-2 How Novell CIFS Works

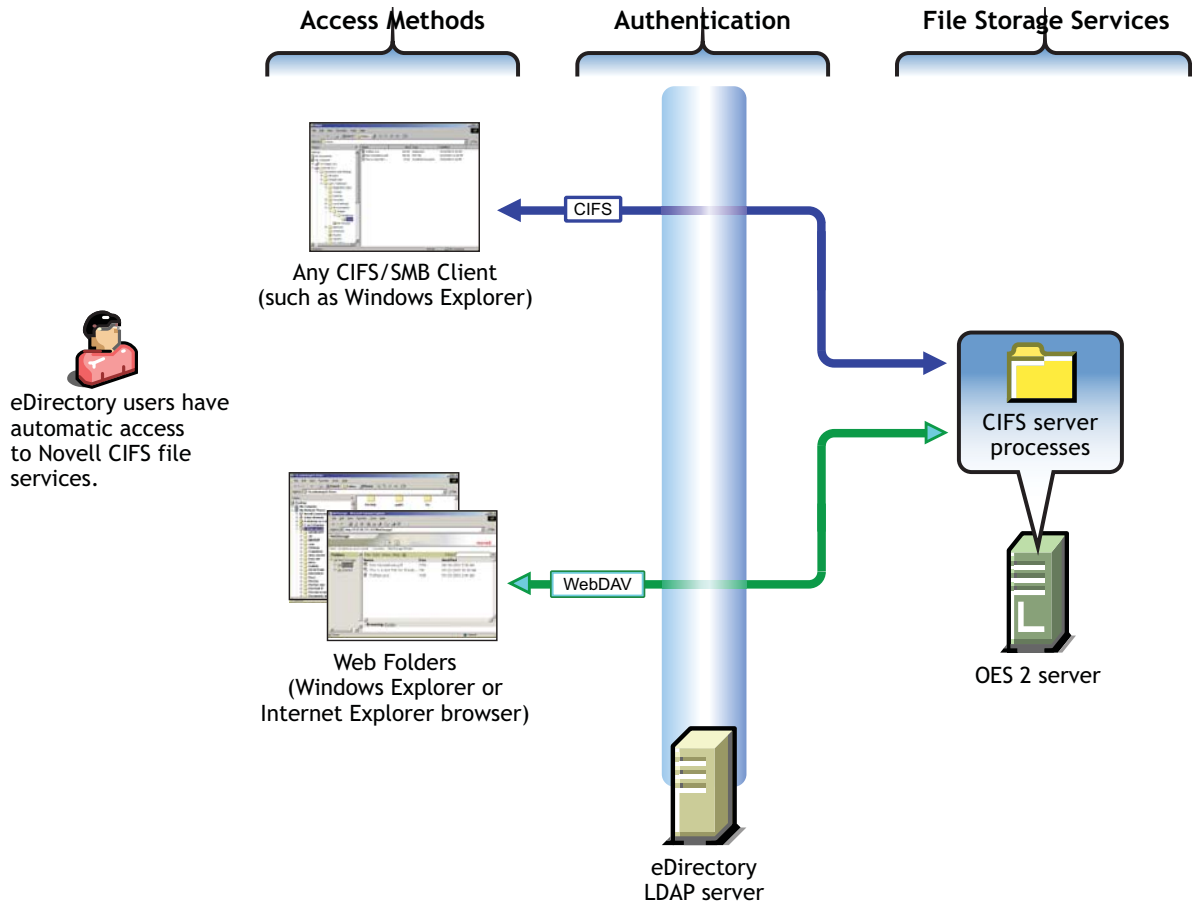

The following table explains the information illustrated in Figure 5-2.

Access Methods	Authentication	CIFS File Services
<p>eDirectory users on Windows workstations have two native Windows file access options:</p> <ul style="list-style-type: none"> ♦ CIFS Client Access: Windows Explorer users can access and modify files on the OES 2 server just as they would on any workgroup server share. ♦ Web Folder: Users can create Web Folders in Windows Explorer or Internet Explorer. <p>Files on the OES 2 server are accessed and maintained with the HTTP-WebDAV protocol.</p>	<p>All file service access is controlled by LDAP-based authentication through the eDirectory LDAP server.</p> <p>Although it is shown separately, eDirectory could be installed on the OES 2 server.</p>	<p>Of course, the same files can also be accessed through other OES file services (such as NetStorage) that connect to NSS volumes.</p>

5.2.2 Platform Differences in CIFS File Services

The differences in CIFS services on NetWare and OES 2 are summarized in the following table.

Table 5-3 CIFS services on NetWare and OES 2

Service	NetWare	OES 2
64-Bit Support	No	Yes
Distributed File Services for NSS Volumes	Yes	Future
OpLocks	Yes	Yes
Cross Protocol Locking	Yes	Future
NSS Support	Yes	Yes
CIFS-enabled shared NSS pool/ volume in a NetWare-to-NetWare or OES-to-OES cluster	Yes	Yes
CIFS-enabled shared NSS pool/ volume in a mixed NetWare-to-OES cluster	No	No
iManager Support and Administration tool	Yes	Yes
File and Record Locking	Yes	Yes
Domain Emulation	Yes	Future
Monitoring	No	Future
Xen Virtualized Host Server Environment	NA	No
Xen Virtualized Guest Server Environment	Yes	Yes
Multi-processor/Multicore Server Support	No	Yes
Multi-File System Support	No	Future
NTLMv2/Kerberos	No	Future

5.2.3 Planning to Upgrade CIFS Services

The OES 2 SP3 Migration Tool supports transferring CIFS file services from NetWare to OES 2. The upgrade process is quite straightforward, but there are, of course, some planning steps that you must take to ensure success.

- ♦ [“Requirements” on page 60](#)
- ♦ [“Limitations” on page 60](#)
- ♦ [“Universal Password” on page 60](#)

Requirements

Table 5-4 CIFS Source and Target Server Requirements

Source Server	Target Server
NetWare 5.1 or later	OES 2 SP3. The Novell CIFS service pattern is installed but not configured. Data can be moved independently of the service. Users can always see what they have rights to see.

Limitations

- ♦ [“Cross-Tree Migration Not Supported” on page 60](#)
- ♦ [“Server Configuration Information Not Transferred with Consolidation” on page 60](#)
- ♦ [“Upgrading Novell Samba Not Supported” on page 60](#)

Cross-Tree Migration Not Supported

The OES 2 SP3 Migration Tool does not support transferring CIFS services across eDirectory trees. However, CIFS services can be effectively transferred by first moving the data to an OES 2 SP3 target server in the other tree, and then configuring CIFS on the target server.

For details, see [“Migrating Data to a Server in a Different Tree”](#) in the *OES 2 SP3: Migration Tool Administration Guide* and [“Installing and Setting Up AFP”](#) in the *OES 2 SP3: Novell AFP For Linux Administration Guide*.

Server Configuration Information Not Transferred with Consolidation

The CIFS shares configuration and CIFS Users contexts are transferred by using both migration types (Consolidate and Transfer ID), but the server configuration information is transferred only with a Transfer ID migration.

Upgrading Novell Samba Not Supported

The OES 2 SP3 Migration Tool does not support Novell Samba as a source service for transferal to Novell CIFS.

Universal Password

A Universal Password policy is required for Novell CIFS.

5.2.4 Upgrading CIFS

You can use either of the two migration types offered by the Migration Tool to transfer CIFS file services from NetWare to OES 2:

- ♦ **Consolidate:** If you want to move just the CIFS shares and associated data to an OES 2 SP3 server, you can perform a consolidation migration. The CIFS server configuration is not transferred. For more information, see [Section A.1.1, “Consolidating Selected Data or Services,” on page 101](#).
- ♦ **Transfer ID:** If you are transferring an entire NetWare server, including the CIFS service and associated data, to an OES 2 SP3 server, then you should perform a Transfer ID migration. For more information, see [Section A.1.2, “Transferring an Entire NetWare Server,” on page 102](#).

To upgrade Novell CIFS from NetWare to OES 2, follow the instructions in “[Migrating CIFS from NetWare to OES 2 SP3 Linux](#)” in the *OES 2 SP3: Migration Tool Administration Guide*.

5.2.5 Post-Upgrade Checks

- ♦ “[Restarting CIFS](#)” on page 61
- ♦ “[Verifying Success](#)” on page 61

Restarting CIFS

After the CIFS service is transferred, restart CIFS at a terminal prompt by using the following command:

```
rcnovell-cifs restart
```

Verifying Success

Be sure to complete the instructions in “[Verifying the Migration](#)” in the *OES 2 SP3: Migration Tool Administration Guide*.

5.3 Upgrading Novell FTP to OES

- ♦ [Section 5.3.1, “About FTP File Services,” on page 61](#)
- ♦ [Section 5.3.2, “Platform Differences in FTP File Services,” on page 61](#)
- ♦ [Section 5.3.3, “Planning,” on page 61](#)
- ♦ [Section 5.3.4, “Transferring FTP Services to OES,” on page 62](#)
- ♦ [Section 5.3.5, “Post-Upgrade Checks,” on page 62](#)

5.3.1 About FTP File Services

Novell FTP (File Transfer Protocol) is integrated with Novell eDirectory so that users can securely transfer files to and from OES 2 or OES NetWare volumes.

5.3.2 Platform Differences in FTP File Services

There are no significant differences.

5.3.3 Planning

- ♦ “Requirements” on page 62
- ♦ “Limitations” on page 62

Requirements

Table 5-5 FTP Source and Target Server Requirements

Source Server	Target Server
NetWare 5.1 or later	OES 2 SP3 with the Novell FTP service pattern installed but not configured.

Limitations

If a configuration exists on the target server, it is overwritten regardless of the migration type.

5.3.4 Transferring FTP Services to OES

You can use either of the two migration types offered by the Migration Tool to transfer FTP file services from NetWare to OES 2:

- ♦ **Consolidate:** Both consolidation on the same tree and consolidation to a different tree are supported. For more information, see [Section A.1.1, “Consolidating Selected Data or Services,” on page 101](#).
- ♦ **Transfer ID:** If you are transferring an entire NetWare server, including the FTP service and associated data, to an OES 2 SP3 server, then you should transfer the entire server configuration. Transfer ID migrations must occur within in the same tree. For more information, see [Section A.1.2, “Transferring an Entire NetWare Server,” on page 102](#).

To transfer Novell FTP from NetWare to OES 2, follow the instructions in “[Migrating FTP from NetWare to OES 2 Linux](#)” in the *OES 2 SP3: Migration Tool Administration Guide*.

5.3.5 Post-Upgrade Checks

Verify a successful upgrade by making sure that the FTP service works as expected. For more information, see “[Post-Migration Procedure](#)” in the *OES 2 SP3: Migration Tool Administration Guide*. For help with LUM-enabling FTP users, see [TID 3503915 \(http://www.novell.com/support/php/search.do?cmd=displayKC&docType=kc&externalId=3503915&sliceId=1&docTypeID=DT_TID_1_1&dialogID=76627759&stateId=0%20%2076625913\)](http://www.novell.com/support/php/search.do?cmd=displayKC&docType=kc&externalId=3503915&sliceId=1&docTypeID=DT_TID_1_1&dialogID=76627759&stateId=0%20%2076625913).

5.4 Upgrading iFolder to OES

- ♦ [Section 5.4.1, “About iFolder on OES 2,” on page 62](#)
- ♦ [Section 5.4.2, “Platform Differences in iFolder File Services,” on page 64](#)
- ♦ [Section 5.4.3, “Planning,” on page 64](#)
- ♦ [Section 5.4.4, “Upgrading iFolder,” on page 65](#)
- ♦ [Section 5.4.5, “Post-Upgrade Checks,” on page 65](#)

5.4.1 About iFolder on OES 2

NetWare runs only iFolder 2.x while OES 2 runs iFolder 3.8, and as the version numbers imply, iFolder on OES 2 is much more robust and flexible.

Figure 5-3 How Novell iFolder 3.8 Works

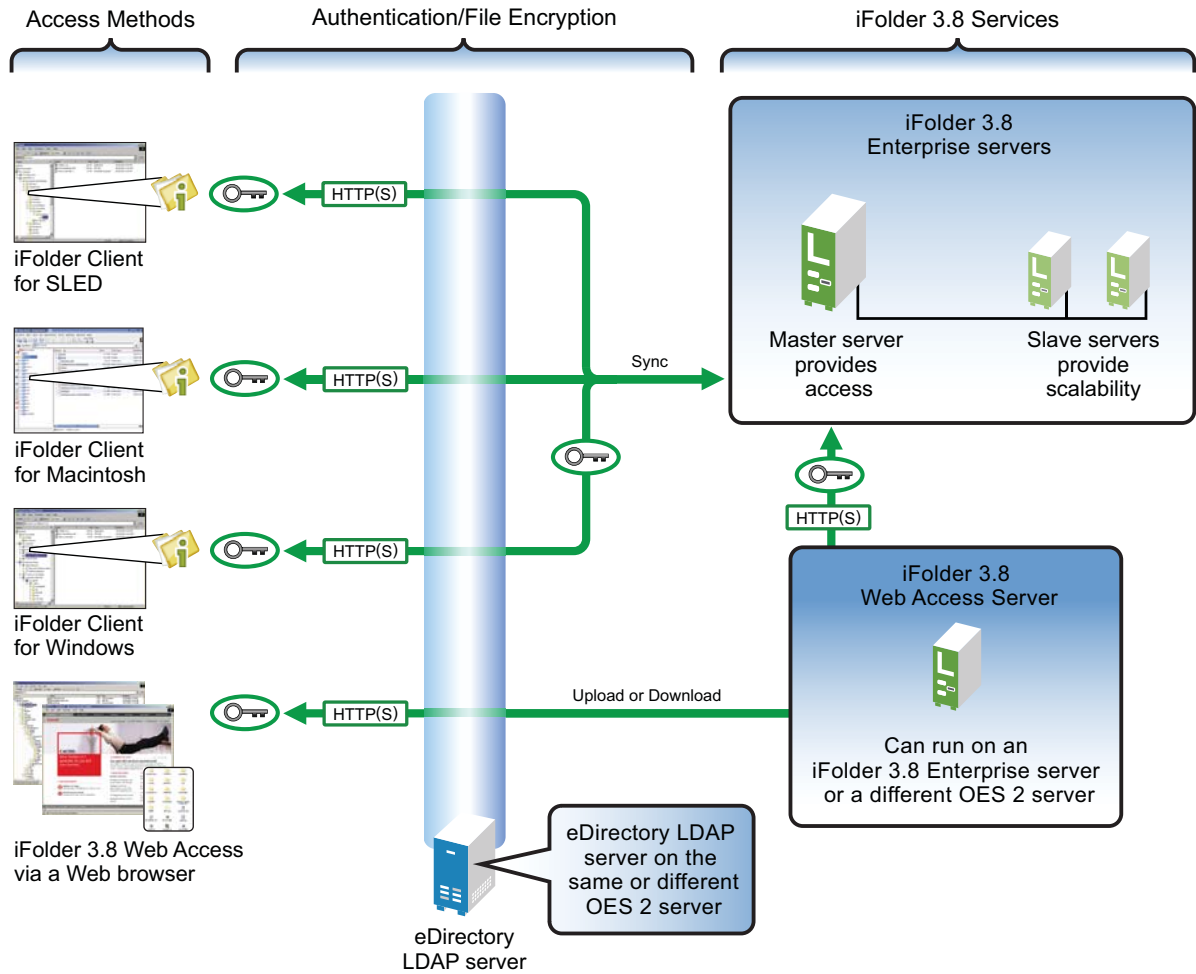

The following table explains the information illustrated in [Figure 5-3](#).

Access Methods	Authentication/File Encryption	Novell iFolder 3.8 Services
Linux, Macintosh, and Windows workstation users who have the Novell iFolder® Client installed can access and modify their files in one or more workstation folders. Changes are automatically synchronized with the iFolder 3.8 Enterprise servers. A Web interface lets users access their files from any computer with an active network or Internet connection.	All file service access is controlled by LDAP- based authentication through the eDirectory LDAP server. Although it is shown separately, eDirectory could be installed on the OES 2 server. Files can be encrypted for transport using SSL connections (HTTPS).	Slave servers can be added as needed, providing the ability to dynamically grow iFolder services without disrupting users. Local and network copies of each file are automatically synchronized by the Novell iFolder Client and Server pieces.

Additional overview information is available in “[Overview of Novell iFolder](#)” in the *Novell iFolder 3.8.4 Administration Guide*.

5.4.2 Platform Differences in iFolder File Services

There are numerous significant differences between iFolder 2.x and iFolder 3.8, including:

- ♦ **Automatic Service Provisioning:** Multiple servers participate in a single iFolder domain, and iFolder user assignments are automatically balanced across the domain.
- ♦ **Multiple iFolders:** Users can use a virtually unlimited number of iFolders.
- ♦ **Sharing iFolders:** Users can share their iFolders with other iFolder users, granting them full, read/write, or read only access.
- ♦ **File-type Synchronization:** If desired, you can limit which file types are synchronized.

For a complete list of differences, see “[Comparing Novell iFolder 2.x with 3.7 and Later Versions](#)” in the *Novell iFolder 3.8.4 Administration Guide*.

5.4.3 Planning

- ♦ “[Requirements](#)” on page 64
- ♦ “[Limitations](#)” on page 64

Requirements

Table 5-6 iFolder Source and Target Server Requirements

Source Server	Target Server
NetWare server with iFolder 2.x installed	One or more OES 2 SP3 servers installed. The iFolder 3.8 service pattern is installed on each server but not configured. All iFolder 3.8 servers, the iFolder 3.8 Web Access server, and eDirectory are up and running.

Source Server	Target Server
	<p>Data must be moved before the iFolder service is transferred.</p> <p>If multiple servers are targeted, data migration is balanced by default. Users are then assigned to the appropriate iFolder. However, other provisioning options are available.</p> <p>For more information, see “Multi-Server Migration” in the <i>OES 2 SP3: Migration Tool Administration Guide</i>.</p>

Limitations

- ♦ “[Moving Encrypted iFolders](#)” on page 65
- ♦ “[iFolder 2.x User Policies Not Transferred](#)” on page 65

Moving Encrypted iFolders

The Migration Tool doesn’t move encrypted iFolders because user passphrases are needed. Each user with an encrypted iFolder needs to perform a client-side migration if they want their iFolder 2.x data moved to iFolder 3.8. For more information, see “[Migrating from iFolder 2.x to iFolder 3.8.4](#)” in the *Novell iFolder 3.8.4 Cross-Platform User Guide*.

iFolder 2.x User Policies Not Transferred

iFolder 2.x configuration settings, such as user policies, are not compatible with iFolder 3.8 and are therefore not transferred. You must set the policies for each user after the migration is complete.

5.4.4 Upgrading iFolder

You can use either of the two migration types offered by the Migration Tool to upgrade iFolder file services from NetWare to OES 2:

- ♦ **Consolidate:** Both consolidation on the same tree and consolidation to a different tree are supported. For more information, see [Section A.1.1, “Consolidating Selected Data or Services,” on page 101](#).
- ♦ **Transfer ID:** If you are transferring an entire NetWare server, including the iFolder service and associated data to an OES 2 SP3 server, then you should transfer the entire server configuration. Transfer ID migrations must occur within the same tree. For more information, see [Section A.1.2, “Transferring an Entire NetWare Server,” on page 102](#).

To upgrade Novell iFolder on NetWare to OES 2, follow the instructions in “[Migrating iFolder 2.x](#)” in the *OES 2 SP3: Migration Tool Administration Guide*.

5.4.5 Post-Upgrade Checks

As mentioned in “[iFolder 2.x User Policies Not Transferred](#)” on page 65, you must set a policy for each user after the upgrade is finished.

5.5 Upgrading NetWare Core Protocol (NCP) File Services

The NetWare Core Protocol (NCP) Server provides the same file services on OES 2 that are available on NetWare.

- ♦ [Section 5.5.1, “About NCP File Services in OES 2,” on page 65](#)
- ♦ [Section 5.5.2, “Planning to Upgrade NCP File Services,” on page 67](#)
- ♦ [Section 5.5.3, “Only Data Transfers Are Required,” on page 68](#)

5.5.1 About NCP File Services in OES 2

- ♦ [“What NCP Server Provides” on page 66](#)
- ♦ [“What NCP Server Alone Doesn’t Provide” on page 67](#)

What NCP Server Provides

With NCP Server, you can define NCP volumes (NCP shares on Linux Ext3 and Reiser file systems). The advantage of using an NCP server is that you can control access using the Novell trustee model. Windows and Linux workstations running Novell Client software can access data and manage file sharing on OES 2 servers just as they do on NetWare servers, unless they need NSS file attributes (see [“What NCP Server Alone Doesn’t Provide” on page 67](#)).

Novell NCP Server for OES enables support for login scripts, mapping drives to OES 2 servers, and other services commonly associated with Novell Client access. This means that Windows users with the Novell Client installed can be seamlessly transitioned to file services on OES 2.

Services provided by NCP include file access, file locking, security, resource allocation tracking, event notification, and synchronization with other servers.

NCP is a client/server LAN protocol. Workstations create NCP requests and use TCP/IP to send them over the network. At the server, NCP requests are received, unpacked, and interpreted.

[Figure 5-4](#) illustrates the basics of NCP file services.

Figure 5-4 NCP Services for OES and NetWare

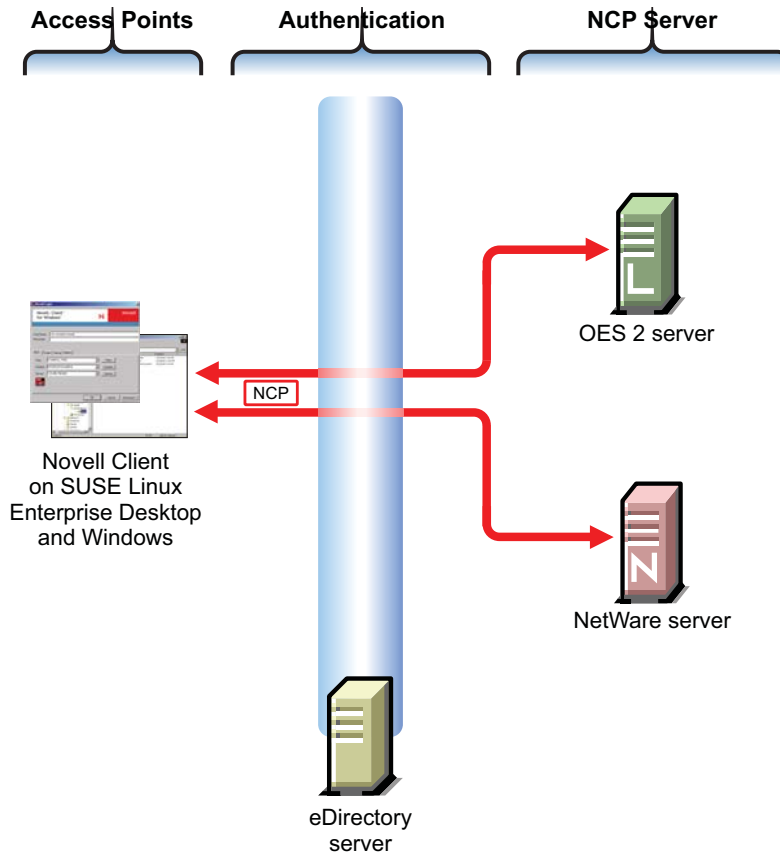

The following table explains the information illustrated in [Figure 5-4](#).

Access Methods	Authentication	NCP Services
Access is through an NCP client—specifically, the Novell Client.	All file service access is controlled by eDirectory authentication.	Files are stored on NetWare or NCP volumes that the administrator has created. The same core set of NetWare file attributes are available on both OES and NetWare.

What NCP Server Alone Doesn't Provide

NSS file attributes and NCP services tend to get mixed together in the minds of NetWare administrators. It is important to remember that file and directory attributes are supported and enforced by the file system that underlies an NCP volume, not by the NCP server.

For example, even though the Rename Inhibit attribute appears to be settable in the NCP client interface, if the underlying file system is Linux POSIX (Reiser, etc.) there is no support for the attribute and it cannot be set.

Salvage (undelete) and Purge are other features that are available only on NSS and only where the Salvage attribute has been set (the NSS default). They can be managed in the NCP client and through NetStorage, but they are not available on NCP volumes where the underlying file system is Linux POSIX.

Some administrators assume they can provide NSS attribute support by copying or moving files, directories, and metadata from an NSS volume to a defined NCP volume on a Linux POSIX partition. However, this doesn't work, because NSS file attributes are only supported on NSS volumes.

5.5.2 Planning to Upgrade NCP File Services

- ♦ [“Requirements” on page 67](#)
- ♦ [“Deciding Between a Linux POSIX File System and NSS” on page 68](#)
- ♦ [“The Novell Client Is Required” on page 68](#)

Requirements

Table 5-7 NCP Source and Target Server Requirements

Source Server	Target Server
NetWare 5.1 or later	OES 2 SP3 The NCP Server pattern is installed. Data can be moved independently of the server. Users can always see what they have rights to see.

Deciding Between a Linux POSIX File System and NSS

For most system administrators, the most critical point of this decision is whether your organization relies on NSS file and directory attributes as a key component of the Novell Trustee Access model. If the answer is yes, then you should move your data to NSS volumes on OES 2, or mount existing NSS volumes on the OES 2 servers.

If your organization doesn't rely on NSS file and directory attributes and wants to transition to NCP volumes defined on Linux POSIX file systems, then you can create those volumes on the target servers and move the data by using the OES 2 SP3 Migration Tool.

The Novell Client Is Required

Novell Client software is required to initiate an NCP connection between a Windows or Linux workstation running Novell Client software and an OES server running NCP Server services. Intelligence at both ends of the connection works together to verify that clients are who they claim to be, and that access controls are followed when using shared server files.

5.5.3 Only Data Transfers Are Required

You provide NCP services on an OES 2 server by installing the NCP Server pattern. There is no upgrade path for the NCP server running on NetWare to NCP Server on OES.

If the data is properly moved to ensure that trustee assignments are left intact, users can access their data using a Novell Client on a Linux or Windows workstation just as they did when the data resided on a NetWare server.

5.6 Upgrading NetStorage

- Section 5.6.1, “About NetStorage,” on page 68
- Section 5.6.2, “Platform Differences in NetStorage File Services,” on page 70
- Section 5.6.3, “NetStorage Is Not Transferred,” on page 71

5.6.1 About NetStorage

NetStorage provides secure Web access to files and folders on your OES and NetWare servers. It is a bridge between a company's protected Novell storage network and the Internet. Using a Web browser, your eDirectory users can securely copy, move, rename, delete, read, write, recover, and set trustee assignments for their files from any Internet-attached workstation, anywhere in the world, with nothing to download or install on the workstation.

NetStorage on OES provides local and Web access to files on many systems without requiring the Novell Client (see [Figure 5-5](#)).

Figure 5-5 How NetStorage Works on OES 2

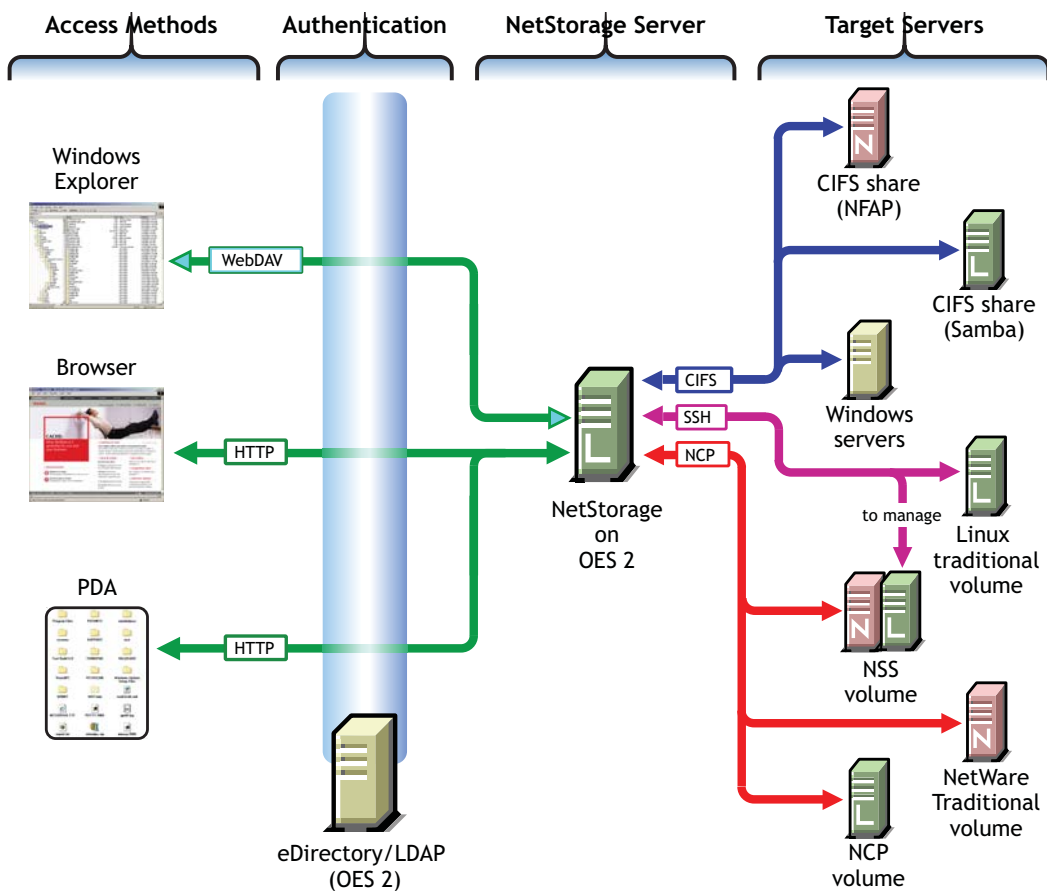

The following table explains the information illustrated in [Figure 5-5](#).

Access Methods	Authentication	NetStorage Server	Target Servers
<p>Users have read and write access to files from</p> <ul style="list-style-type: none"> ♦ Windows Explorer: Is enabled by the HTTP protocol with WebDAV extensions. ♦ Browsers: Users can access files directly by connecting to the NetStorage server. ♦ PDA: PDA users with network connections can also access their files. <p>Access is granted through login script drive mapping (NCP server required) or through Storage Location Objects.</p>	<p>File service access is controlled by LDAP-based authentication through the eDirectory LDAP server.</p> <p>Although it is shown separately, eDirectory could be running on the OES 2 server.</p>	<p>The NetStorage server receives and processes connection requests and provides access to storage on various servers on the network.</p>	<p>NetStorage on OES can connect eDirectory users to their files and folders stored in the following locations:</p> <ul style="list-style-type: none"> ♦ The same targets as NetWare if the NCP server is running ♦ Windows workgroup shares (CIFS or Samba shares) ♦ Linux POSIX volumes through an SSH connection. <p>Linux volumes can also be made available as NCP volumes.</p> <p>Management of NSS volumes on OES 2 through NetStorage requires SSH access to the server. See “When Is SSH Access Required?” in the <i>OES 2 SP3: Planning and Implementation Guide</i>.</p>

5.6.2 Platform Differences in NetStorage File Services

Although NetStorage provides the same basic services on NetWare and OES 2, there are significant configuration differences, most of which are a natural result of the platform differences between NetWare and OES:

Table 5-8 *NetStorage Platform Differences*

NetWare	OES 2
NetWare servers store data on NSS volumes.	OES servers accommodate many different file systems, including NSS.
NetStorage is completely integrated with eDirectory and NetWare.	NetStorage is well integrated with eDirectory and OES.
NetStorage relies heavily on NCP login scripts to provision user access to the storage locations it points to.	NetStorage uses Storage Location Objects to provision storage locations that users access based on their rights.
NetStorage provides automatic Web access for iFolder 2.x when that service is installed on the same server as NetStorage.	An integration with iFolder 3.8 is not needed because the iFolder 3.8 Web Server provides Web access for iFolder users.

Despite these differences, NetStorage on OES 2 is every bit as valuable as NetStorage on NetWare and is well worth the small amount of time required to install and configure it.

5.6.3 NetStorage Is Not Transferred

Because of the differences explained above, it doesn't make sense to transfer an exact NetStorage configuration from NetWare to OES 2. Instead, you should move your data by using the Migration Tool, then install and configure NetStorage on the OES2 server.

For most networks, NetStorage needs to be installed on only one server; however, this might vary depending on the size of your network and your organization's needs. For example, if your company is geographically dispersed, you might want to install NetStorage on one server in each geographic region.

NetStorage can also be set up in a clustered environment so that if a NetStorage server goes down, another NetStorage server in the cluster can take over the function of the downed server, and users don't lose access to data.

For more information, see

- ♦ [“NetStorage Implementation and Maintenance”](#) in the *OES 2 SP3: Planning and Implementation Guide*
- ♦ *OES 2 SP3: NetStorage Administration Guide*.

6 Upgrading Print Services to OES

- ♦ [Section 6.1, “About iPrint,” on page 73](#)
- ♦ [Section 6.2, “Platform Differences in iPrint,” on page 73](#)
- ♦ [Section 6.3, “Planning to Upgrade iPrint to OES,” on page 73](#)
- ♦ [Section 6.4, “Upgrading iPrint to OES,” on page 75](#)
- ♦ [Section 6.5, “Additional Information,” on page 75](#)

TIP: If any printers in your environment have IPX™ enabled but not configured, you should disable them to free up JetDirect* and LAN bandwidth.

6.1 About iPrint

The currently supported Novell® print service, iPrint, is a greatly enhanced version of NDPS that is:

- ♦ Completely IP-based and platform independent on both the client and server side
- ♦ Not dependent on the Novell Client™
- ♦ Web-based for both printer provisioning and deployment
- ♦ Fully cluster-aware

6.2 Platform Differences in iPrint

There are two basic differences between iPrint on NetWare® and iPrint on OES 2, neither of which should impact your upgrade plans:

- ♦ The back end infrastructures are different
- ♦ iPrint on OES does not support NDPS/NCP™ client-based printing

Both OES and NetWare support the same iPrint workstation agent.

6.3 Planning to Upgrade iPrint to OES

- ♦ [Section 6.3.1, “Requirements and Recommendations,” on page 74](#)
- ♦ [Section 6.3.2, “Limitations,” on page 74](#)

6.3.1 Requirements and Recommendations

- ♦ [“Platforms” on page 74](#)
- ♦ [“Prepare the Workstations First” on page 74](#)
- ♦ [“Use DNS Names Rather than IP Addresses” on page 74](#)

Platforms

Table 6-1 *iPrint Source and Target Server Requirements*

Source Server	Target Server
NetWare 5.1 or later	OES 2 SP3 with iPrint installed and the Driver Store configured

Prepare the Workstations First

Novell recommends deploying the iPrint agent to workstations before converting the backend infrastructure to OES 2. This will allow for the phased removal of the NDPS-based printers from the workstations before it becomes a requirement with the deployment of iPrint on OES 2. This will allow for a phased and transparent OES 2 printing services for users.

Automated tools are available to deploy the iPrint agent to any workstations still using NDPS. This can also be done using a ZENworks application deployment. A silent install option is available.

Use DNS Names Rather than IP Addresses

An additional consideration is the use of literal IP addresses vs. DNS entries with the printer configurations deployed to the workstations. If the printer/manager configurations are using IP address assignments rather than DNS, Novell recommends deploying the iPrint agent to all of the workstations and changing the existing iPrint managers to a DNS configuration. This will allow you to convert to iPrint in OES without having to revisit the workstations.

If you use DNS, the new iPrint infrastructure can be transferred to OES in phases while leaving the existing NetWare infrastructure in place. The users are converted over when the DNS entry for each individual print manager is changed.

6.3.2 Limitations

You can't migrate printer object ACL (Access Control List) assignments when migrating cross-tree.

When migrating from OES 1 to OES2, the iPrint Direct setting from the source printer agents will not get transferred to OES 2.

6.4 Upgrading iPrint to OES

iPrint can be installed and configured on OES 2 in parallel with an existing print environment to allow for a phased migration of users to the iPrint infrastructure. While iPrint can be used to support queue-based printing, it is not the preferred method (the only normal requirement to maintain a queue is to support legacy DOS-based applications that print directly to a queue rather than to a Windows printer or LPT port).

Novell recommends the following steps to bring a current printing environment up to supported standards before transferring your print infrastructure to OES 2 clusters as required:

- ◆ Install and configure iPrint on any NetWare 6.5 clusters.
- ◆ Install and configure all network printers in iPrint.
- ◆ Install and configure web-based client deployment tools.
- ◆ Set up iPrint on OES 2.
- ◆ Deploy iPrint agents to workstations.

Novell's Server Consolidation and Migration Tool or the OES 2 SP3 Migration Tool are available to copy a NetWare-based iPrint/NDPS environment to an OES iPrint infrastructure. This allows for a phased parallel installation approach to an OES upgrade with minimal user and administrative impacts. Using a mixed OES and NetWare based printing environment within the same tree is fully supported.

6.5 Additional Information

See [“Migrating iPrint from NetWare or OES 2 Linux to OES 2 SP3 Linux”](#) in the *OES 2 SP3: Migration Tool Administration Guide*.

7 Upgrading QuickFinder to OES

This section provides information about upgrading QuickFinder™ from NetWare® to OES. For complete information, refer to the *OES 2 SP3: Novell QuickFinder Server 5.0 Administration Guide*.

- ♦ [Section 7.1, “About QuickFinder in OES 2,” on page 77](#)
- ♦ [Section 7.2, “Platform Differences in QuickFinder,” on page 77](#)
- ♦ [Section 7.3, “Planning to Upgrade QuickFinder,” on page 78](#)
- ♦ [Section 7.4, “Upgrading QuickFinder to OES,” on page 78](#)
- ♦ [Section 7.5, “Post-Upgrade Considerations,” on page 78](#)

7.1 About QuickFinder in OES 2

QuickFinder lets users search for information on any of your public and private Web sites, partners' sites, and any number of additional Web sites across the Internet or on internal file servers, all from a single search form on your Web page.

The look and feel of the search page is configurable so you can match your corporate design.

Using the QuickFinder Unicode* indexing engine, you can create full-text indexes of

- ♦ HTML
- ♦ XML
- ♦ PDF
- ♦ Word
- ♦ OpenOffice.org documents
- ♦ Many other document formats in almost any language

You can also configure and maintain such indexes remotely from anywhere on the network with the QuickFinder Web-based administration module.

7.2 Platform Differences in QuickFinder

There are no significant differences between QuickFinder running on NetWare and QuickFinder running on OES 2.

7.3 Planning to Upgrade QuickFinder

Upgrading QuickFinder to OES is a manual process, but it is also very straightforward, as is the planning process:

1. Identify the QuickFinder service you plan to upgrade from NetWare to OES 2.
2. Install QuickFinder on the OES 2 server, using the Novell QuickFinder service pattern.

7.4 Upgrading QuickFinder to OES

Complete the instructions in “[Migrating QuickFinder Server from NetWare to OES 2 Linux](#)” in the *OES 2 SP3: Novell QuickFinder Server 5.0 Administration Guide*.

7.5 Post-Upgrade Considerations

Complete the instructions in “[Post-Migration Considerations](#)” in the *OES 2 SP3: Novell QuickFinder Server 5.0 Administration Guide*.

8 Upgrading Backup Services to OES

- ♦ [Section 8.1, “Upgrading Novell Archive and Versioning Services to OES,” on page 79](#)
- ♦ [Section 8.2, “About Upgrading Storage Management Services \(SMS\),” on page 80](#)

8.1 Upgrading Novell Archive and Versioning Services to OES

- ♦ [Section 8.1.1, “About Archive and Versioning Services in OES 2,” on page 79](#)
- ♦ [Section 8.1.2, “Platform Differences in Archive and Versioning Services,” on page 79](#)
- ♦ [Section 8.1.3, “Planning to Upgrade Archive and Versioning Services,” on page 79](#)
- ♦ [Section 8.1.4, “Upgrading Archive and Versioning Services,” on page 80](#)
- ♦ [Section 8.1.5, “Post-Upgrade Procedures,” on page 80](#)

8.1.1 About Archive and Versioning Services in OES 2

Archive and Versioning Services provide a convenient and cost-effective way for individual users to instantly restore previous versions of modified, renamed, or deleted files. Interval-based file versions are archived and presented for restoration based on the date of the file change or the user who modified the files. To restore a file, users simply view a list of the archived file versions and select the version they want.

8.1.2 Platform Differences in Archive and Versioning Services

The setup process varies slightly between NetWare and OES 2, but there are no functional differences.

8.1.3 Planning to Upgrade Archive and Versioning Services

- ♦ [“Requirements” on page 79](#)
- ♦ [“Limitations” on page 80](#)

Requirements

Before upgrading, make sure to do the following:

1. Install an NSS volume on the OES 2 server.
2. Make sure the Archive server and the Primary volume reside in the same eDirectory™ tree.
3. Make sure the Archive server, PostgreSQL database, and Archive volume are installed on the same machine.

Table 8-1 Archive and Versioning Source and Target Server Requirements

Source Server	Target Server
NetWare 6.5 SPX	OES 2 SP3. The Novell Archive and Versioning Services pattern is installed but not configured. The Archive volume, configuration file, and the database are moved as part of the process.

Limitations

If a configuration exists on the target server, it is overwritten regardless of the migration type.

8.1.4 Upgrading Archive and Versioning Services

You can use either of the two migration types offered by the Migration Tool to transfer Archive and Versioning Services from NetWare to OES 2:

- ♦ **Consolidate:** Only consolidation on the same tree is supported. For more information, see [Section A.1.1, “Consolidating Selected Data or Services,” on page 101](#).
- ♦ **Transfer ID:** You can transfer an entire NetWare server, including Novell Archive and Versioning Services, to an OES 2 SP3 server. Transfer ID migrations must occur within in the same tree. For more information, see [Section A.1.2, “Transferring an Entire NetWare Server,” on page 102](#).

To upgrade Novell Archive and Versioning Services from NetWare to OES 2, follow the instructions in “[Migrating Novell Archive and Version Services to OES 2 SP3 Linux](#)” in the *OES 2 SP3: Migration Tool Administration Guide*.

8.1.5 Post-Upgrade Procedures

Before restarting the Archive server, be sure to complete the steps in “[Verifying Migration](#)” in the *OES 2 SP3: Migration Tool Administration Guide*.

8.2 About Upgrading Storage Management Services (SMS)

The Novell Storage Management Services™ (SMS) backup infrastructure provides backup applications with the framework to develop a complete backup and restore solution.

SMS helps back up file systems (such as NSS) or application data, such as data from GroupWise® on NetWare and SUSE® Linux Enterprise Server (SLES), to removable tape media or other media for off-site storage. It provides a single consistent interface for all file systems and applications across NetWare and SLES.

The upgrade path for SMS is to install it on the OES 2 server.

9 Upgrading Network Services to OES

Network services are critical to event coordination and service discovery.

- ♦ [Section 9.1, “Upgrading DNS Services to OES,” on page 81](#)
- ♦ [Section 9.2, “Upgrading DHCP Services to OES,” on page 82](#)
- ♦ [Section 9.3, “Time Synchronization,” on page 83](#)
- ♦ [Section 9.4, “Service Location Protocol \(SLP\),” on page 85](#)

9.1 Upgrading DNS Services to OES

With OES 2, DNS has been integrated with eDirectory™. This means you can transition your existing DNS infrastructure from NetWare® to OES, as well as centrally administer it the same way you do on NetWare.

- ♦ [Section 9.1.1, “About Novell DNS in OES 2,” on page 81](#)
- ♦ [Section 9.1.2, “Platform Differences in Novell DNS,” on page 81](#)
- ♦ [Section 9.1.3, “Planning to Upgrade Novell DNS,” on page 81](#)
- ♦ [Section 9.1.4, “Upgrading DNS,” on page 82](#)

9.1.1 About Novell DNS in OES 2

To accomplish eDirectory integration for DNS, Novell® did a full port of NetWare DNS to OES to make it functionally equivalent to DNS in NetWare 6.5. Novell plans in the future to fully integrate all of the required functionality into the open source BIND project.

The administration of DNS does not change between NetWare and OES 2; either iManager or the Java* console can be used as the administrative tool. If you are using the Novell NetWare DNS and DHCP services and hosting it via a cluster, this configuration can also be carried forward into an OES 2 environment.

9.1.2 Platform Differences in Novell DNS

DNS platform differences are summarized in [“DNS Differences Between NetWare and OES 2”](#) in the *OES 2 SP3: Planning and Implementation Guide*.

9.1.3 Planning to Upgrade Novell DNS

- ♦ [“Requirements” on page 82](#)
- ♦ [“Limitations” on page 82](#)

Requirements

Table 9-1 DNS Source and Target Server Requirements

Source Server	Target Server
NetWare 5.1 SP8	OES 2 SP3.
NetWare 6.0 SP5 or later	
NetWare 6.5 SP5 or later	
	The Novell DNS service pattern is installed.
	The schema is extended, the DNS-DHCP group is created, and the RootServerInfo and DNS-DHCP Locator objects are created.
	The installing administrator has rights to update files on the target server and is a member of the DNS-DHCP Group.

Limitations

9.1.4 Upgrading DNS

DNS servers can be transferred both within and across eDirectory trees by using either iManager or the Java Console. The OES 2 SP3 Migration Tool doesn't support DNS migrations.

For instructions, see "[Migrating DNS from NetWare to OES 2 SP3 Linux](#)" in the *OES 2 SP3: Migration Tool Administration Guide*.

9.2 Upgrading DHCP Services to OES

With OES 2, DHCP has been integrated with eDirectory. This means you can transition your existing DHCP infrastructure from NetWare to OES, as well as centrally administer it the same way you do on NetWare.

- ♦ [Section 9.2.1, "About Novell DHCP in OES 2,"](#) on page 82
- ♦ [Section 9.2.2, "Platform Differences in Novell DHCP,"](#) on page 83
- ♦ [Section 9.2.3, "Planning to Upgrade Novell DHCP,"](#) on page 83
- ♦ [Section 9.2.4, "Upgrading DHCP,"](#) on page 83

9.2.1 About Novell DHCP in OES 2

The DHCP services in OES 2 have been enhanced to store configuration information in eDirectory just as NetWare implementations do.

After the DHCP information has been migrated to OES 2, administration can be performed through iManager and also an update to the DNS/DHCP Java Console.

9.2.2 Platform Differences in Novell DHCP

DHCP platform differences are summarized in “[DHCP Differences Between NetWare and OES 2](#)” in the *OES 2 SP3: Planning and Implementation Guide*.

9.2.3 Planning to Upgrade Novell DHCP

- ♦ “[Requirements](#)” on page 83
- ♦ “[Limitations](#)” on page 83

Requirements

Table 9-2 DHCP Source and Target Server Requirements

Source Server	Target Server
NetWare 5.1 or later	OES 2 SP3. The Novell DHCP service pattern is installed and configured. The source and target servers have their times synchronized.

Limitations

9.2.4 Upgrading DHCP

To transfer Novell DHCP services from NetWare to OES 2, follow the instructions in “[Migrating DHCP from NetWare to OES 2 SP3 Linux](#)” in the *OES 2 SP3: Migration Tool Administration Guide*.

9.3 Time Synchronization

Time synchronization is critical to maintaining the integrity of the tree.

- ♦ [Section 9.3.1, “About Time Synchronization in OES 2,”](#) on page 83
- ♦ [Section 9.3.2, “Planning to Upgrade Time Synchronization Services,”](#) on page 84
- ♦ [Section 9.3.3, “Transferring Time Synchronization Services,”](#) on page 85

9.3.1 About Time Synchronization in OES 2

In earlier versions of eDirectory, replica synchronization required proper time synchronization. Currently, replica synchronization uses time stamps from host servers without checking for proper time synchronization. This means that if the host servers are not time-synchronized, events can be logged out of sequence, resulting in inconsistent information about what took place and in what order.

What NTP Provides

All servers with Internet access can get time from NTP servers on the Internet. NTP synchronizes clocks to the Universal Time Coordinated (UTC) standard, which is the international time standard. The hierarchy that indicates where each server is getting its time is referred to as a stratum, with the first time provider designated as stratum 1.

A server that gets its time from a stratum 1 server is stratum 2, and so on.

The TIMESYNC NLM™ can consume and provide NTP time, but it always functions as stratum 5.

Use a Reliable, External Time Source

By default, NTP uses the server's internal clock as its time provider, but it can be configured to use other time providers via the `/etc/ntp.conf` file.

NTP time can be supplied from several sources:

- ♦ **Public Time Server.** For small organizations (fewer than 100 servers), synchronizing servers to accurate public NTP servers provides sufficient time synchronization. To reduce traffic, it's best to have one or two servers synchronize with a public NTP source and have those servers provide time for the remaining servers. See <http://ntp.isc.org/bin/view/Servers/WebHome>.

Reference Clock. Reference clocks are devices that synchronize via a variety of technologies including long wave radio signals, GPS transmissions, or CDMA technology. These can be expensive.

Server's Local Clock. The server's internal clock can be used as a time source, but because time can wander, this is generally not a preferred solution.

Network NTP Time Source. This is the recommended option for larger networks. In this case, you need to set up a server as an NTP time provider and then add the IP address of the time source to the `/etc/ntp.conf` file for servers that will use the designated server as the time provider.

9.3.2 Planning to Upgrade Time Synchronization Services

Both the OES and the NetWare installs automate the time synchronization process where possible. For complete information about planning and implementing a time synchronization strategy and setting up time providers and consumers, see “[Time Services](#)”, particularly “[Implementing Time Synchronization](#)” in the *OES 2 SP3: Planning and Implementation Guide*.

Also consider the following points.

- ♦ Designate the most reliable server in the subnet as the time provider.
- ♦ Configure at least two time providers to set fault tolerance.
- ♦ Configure time consumers to contact a time provider within its own local network (so they don't contact time providers across costly WANs).
- ♦ Generally, only one server in a network should communicate with an external time provider. This reduces network traffic across geographical locations and minimizes traffic across routers and WANs.

NOTE: The time synchronization modules in Novell Open Enterprise Server (OES) have been designed to ensure that new OES 2 servers can be introduced into an existing network environment without disrupting any of the products and services that are in place.

9.3.3 Transferring Time Synchronization Services

You can use either of the two migration types offered by the Migration Tool to transfer time synchronization services from NetWare to OES 2:

- ♦ **Consolidate:** Both consolidation on the same tree and consolidation to a different tree are supported. For more information, see [Section A.1.1, “Consolidating Selected Data or Services,” on page 101](#).
- ♦ **Transfer ID:** Transfer ID migrations must occur within in the same tree. For more information, see [Section A.1.2, “Transferring an Entire NetWare Server,” on page 102](#).

To transfer time synchronization services from NetWare to OES 2, follow the instructions in [“Migrating Timesync/NTP from NetWare to NTP on OES 2 Linux”](#) in the *OES 2 SP3: Migration Tool Administration Guide*.

9.4 Service Location Protocol (SLP)

SLP is not a migratable service, however, it is a critical component of OES 2 and must be planned as part of your upgrade strategy.

- ♦ [Section 9.4.1, “About SLP in OES 2,” on page 85](#)
- ♦ [Section 9.4.2, “Platform Differences in SLP Services,” on page 85](#)
- ♦ [Section 9.4.3, “Setting Up SLP on OES 2,” on page 86](#)

9.4.1 About SLP in OES 2

SLP lets network services register their availability on the network. SLP agents then keep track of which services are available and provide that information to applications that need it, such as the Novell Client™.

For example, without an advertisement or discovery mechanism like SLP, users must know the IP address or DNS name of a server hosting the tree in order to log in and use network services. Without SLP, browsing for trees on the network would not be possible.

9.4.2 Platform Differences in SLP Services

- ♦ [“SLP on NetWare” on page 85](#)
- ♦ [“SLP on OES 2 SP3” on page 86](#)
- ♦ [“Caveats” on page 86](#)

SLP on NetWare

NetWare uses a Novell customized version of SLP called Novell SLP that provides an additional agent type, the Directory Agent or DA, which can synchronize information between DAs.

On NetWare, SLP services are integrated with and configured to automatically work with eDirectory and other services; if eDirectory is configured correctly, the services work without SLP.

If you have a NetWare tree, you automatically have Novell SLP on your network and you can continue to use it as the SLP service during your upgrade to OES 2.

The Novell version of SLP takes certain liberties with the SLP standard in order to provide a more robust service advertising environment, but it does so at the expense of some scalability. For a discussion of SLP and OpenSLP and references to documents essential to understanding the protocol, refer to “[Configuring OpenSLP for eDirectory](#)” in the *Novell eDirectory 8.8 Installation Guide*.

SLP on OES 2 SP3

Novell provides a basic level of SLP support when eDirectory is installed on an OES server. OES servers are configured with an SA that registers SLP-aware applications (such as eDirectory) with the server.

However, you should configure OpenSLP (the default SLP service for OES), especially if you are installing more than three servers in a replica ring or eDirectory partition. The first three servers in a replica ring or eDirectory partition have an eDirectory replica installed automatically. The fourth and subsequently installed servers in a replica ring or eDirectory partition must have SLP configured for all services to work properly.

Caveats

- ◆ DA synchronization is not part of OpenSLP.
- ◆ If you are running NetWare 5.1 in your tree, it must be at SP8 to have SLP version 2 functionality. Older versions are not compatible with OpenSLP running on OES 2.
- ◆ If your workstations can connect to the server using its IP address but not its DNS name, you need to update to Novell Client 4.91 SP5 or later. See [TID 3890003](http://www.novell.com/support/php/search.do?cmd=displayKC&docType=kc&externalId=3890003&sliceId=1&docTypeID=DT_TID_1_1&dialogID=66172729&stateId=0%20%2066174133) (http://www.novell.com/support/php/search.do?cmd=displayKC&docType=kc&externalId=3890003&sliceId=1&docTypeID=DT_TID_1_1&dialogID=66172729&stateId=0%20%2066174133).

9.4.3 Setting Up SLP on OES 2

- ◆ “[Enabling Multicasting](#)” on page 86
- ◆ “[Installing and Configuring OpenSLP](#)” on page 87
- ◆ “[Additional Information](#)” on page 87

Enabling Multicasting

SLP relies on multicasting; however, most Linux systems are not configured, by default, to provide multicast support. Enter the following at the shell prompt to determine whether multicasting is supported:

```
route -n
```

If multicasting is supported, you see an entry in the routing table for the 224.0.0.0 destination.

If not:

- 1 Open a terminal session.
- 2 Change to the root user account.
- 3 At the shell prompt, enter the following command:

```
route add -net 224.0.0.0 netmask 240.0.0.0 dev interface
```

(eth0 is usually the *interface* parameter)

- 4 Verify that the route has been added by entering `route -n` at the shell prompt.

Installing and Configuring OpenSLP

Open SLP is available as an RPM and provides UA, SA, and DA functionality. You can download a copy from <http://www.openslp.org/> (<http://www.openslp.org/>). It is also included with SLES 10 SP1.

OpenSLP installs like any other RPM by using the `rpm -i` command. The `slpd` daemon is installed in the `/usr/sbin` directory on the server.

After it is installed, you can configure the `slpd` daemon by editing the `/etc/slp.conf` file.

- ♦ To configure the daemon to run every time the server is booted, use the following command:

```
chkconfig slpd 345
```
- ♦ To configure an OES 2 server as a DA, edit the “Static Scope and DA Configuration” portion of the file.
- ♦ To run the daemon, enter `slpd` at the shell prompt.

For additional OpenSLP setup instructions, see “[Setting Up OpenSLP on OES 2 Networks](#)” in the *OES 2 SP3: Planning and Implementation Guide*.

Additional Information

- ♦ *Novell eDirectory 8.8 Administration Guide*, “[Configuring OpenSLP for eDirectory](#)”

10 Upgrading Novell Cluster Services to OES

Novell® Cluster Services™ is a server clustering system that allows you to configure up to 32 OES servers into a high-availability cluster. You can move resources, either manually or automatically, to any server in the cluster. It is enabled for Novell eDirectory™ and supports failover, failback, and load balancing of individually managed cluster resources including data, applications, and services.

- ♦ [Section 10.1, “Overview,” on page 89](#)
- ♦ [Section 10.2, “Planning to Upgrade Novell Cluster Services,” on page 90](#)
- ♦ [Section 10.3, “Prerequisites,” on page 91](#)
- ♦ [Section 10.4, “Caveats,” on page 92](#)
- ♦ [Section 10.5, “Rolling Cluster Conversions,” on page 92](#)

10.1 Overview

You can add OES nodes to an existing NetWare 6.5 cluster without bringing down the cluster, or you can create an all-OES cluster. With a mixed cluster, you can transfer services between OS kernels, and if services (such as NSS) are alike on both platforms, you can set the services to fail over across platforms.

Typical cluster configurations normally include a shared disk subsystem connected to all servers in the cluster. This disk subsystem can be connected via high-speed Fibre Channel cards, cables, and switches for best performance, or by a shared SCSI or iSCSI for a low-cost SAN. If a server fails, another designated server in the cluster automatically mounts the shared disk directories previously mounted on the failed server. This gives network users continuous access to the directories on the shared disk subsystem.

Novell Cluster Services can be set up on OES in several ways:

- ♦ Implementing a new installation on OES that is separate from your NetWare cluster. The pattern install also installs these complementary services:
 - ♦ Novell Backup/Storage Management Services (SMS)
 - ♦ Novell Linux User Management (LUM)
 - ♦ Novell Remote Manager (NRM)
- ♦ Adding OES nodes to an existing NetWare cluster
- ♦ Changing existing NetWare cluster nodes to OES cluster nodes (Rolling Cluster Conversion)
- ♦ Using a mixed NetWare/OES cluster

Using the Novell Cluster Services tool to manage live cluster transfers from the Novell NetWare OS to Novell SUSE® Linux via a rolling conversion is one of the easier methods and is documented [here](#).

10.2 Planning to Upgrade Novell Cluster Services

- ♦ [Section 10.2.1, “Reviewing the Current Cluster,” on page 90](#)
- ♦ [Section 10.2.2, “Upgrading Novell Cluster Services to OES 2,” on page 90](#)
- ♦ [Section 10.2.3, “Additional Information,” on page 91](#)

10.2.1 Reviewing the Current Cluster

Typically, the primary purpose of a cluster is to provide file and print services. Make sure you check the volume resources because it is easy to overload these services. As a general guideline, Novell recommends that NSS volume resources be kept at a total capacity of 80% or less. If you need to reduce the number of standalone servers in production, the logical approach is to move data and transfer services into the high availability resources of a cluster.

- ♦ Review the health of NCS background operations to resolve any operational issues with the cluster.
- ♦ Make sure all cluster nodes are up to the latest support pack levels.
- ♦ Avoid spanning LUNs across NSS pools
- ♦ Where necessary, review and modify the cluster design to take full advantage of the High Availability capabilities of current release software.

Novell recommends the following steps to address both the reliability and the performance of your current cluster:

- ♦ Make sure all NetWare nodes are at NetWare 6.5 SP7 or later
- ♦ Use relatively small LUNs and data volumes
- ♦ Introduce OES 2 nodes as required
- ♦ Reconfigure the SAN to host DST shadow volumes

10.2.2 Upgrading Novell Cluster Services to OES 2

There are two paths for moving existing NetWare clusters to OES: converting the existing clusters (also referred to as a rolling cluster conversion) or using a parallel build.

- ♦ **Cluster Conversion (Same Cluster).** In order to convert existing clusters, new OES 2 servers need to be built with the same LUN visibility as the existing NetWare nodes and the new servers added to the existing cluster. The new OES nodes then mount the existing volumes and services, and the NetWare servers are removed from the cluster and removed from eDirectory. Although it is feasible to use a mixed NetWare and OES cluster temporarily as an upgrade strategy, Novell does not recommend it as a permanent production implementation.
- ♦ **Parallel Build (New Cluster).** A parallel-build OES upgrade strategy entails building a new separate OES 2 cluster on the same SAN as the existing NetWare clusters. Doing so allows resources to be moved to the new cluster by changing LUN visibility from the old cluster nodes to the new. This can also be done in a phased approach. After the last resource is moved, the NetWare cluster can be removed from the tree. Because it is a new cluster, the virtual server names will change and login scripts and other references will need to be updated during the upgrade process.

There are pros and cons to each approach so you need to do a more detailed analysis and have assistance from Novell Consulting before upgrading a cluster.

Novell Cluster Services software must be running on the OES server (SLES 10 and OES 2 must be installed on every server you want to add to a cluster). You can install Novell Cluster Services and create a new cluster, or add a server to an existing cluster either during the SLES 10/OES installation or afterwards, using YaST.

See [“Installing Novell Cluster Services during a OES 2 Linux Installation”](#) and [“Installing Novell Cluster Services on an Existing OES 2 Linux Server”](#) in the *OES 2 SP3: Novell Cluster Services 1.8.8 Administration Guide for Linux*.

10.2.3 Additional Information

Refer to the following sections in the *OES 2 SP3: Novell Cluster Services 1.8.8 Administration Guide for Linux* for additional information about transferring Novell Cluster Services to OES:

- ♦ [“Converting NetWare 6.5 Clusters to OES 2 Linux”](#)
- ♦ [“Upgrading OES 1 Linux Clusters to OES 2 Linux”](#)

10.3 Prerequisites

- ♦ Any NetWare cluster to be converted must be running at least NetWare 6.0. If you have a NetWare 5.1 cluster, you must upgrade to a NetWare 6.5 cluster before adding new OES cluster nodes or converting existing NetWare cluster nodes to OES cluster nodes. The process for converting 6.0 and 6.5 nodes is the same.
- ♦ Each OES server must contain at least one local disk device.
- ♦ At least 512 MB of memory must be available on each server in the cluster.

While identical hardware for each cluster server is not required, having servers with the same or similar processors and memory can reduce differences in performance between cluster nodes.

- ♦ All nodes in a given cluster, whether NetWare or OES:
 - ♦ Must be configured with a static IP address.
An additional IP address needs to be available for the cluster and for each cluster resource and cluster-enabled pool.
 - ♦ Must reside on the same IP subnet and in the same eDirectory tree.
- ♦ A shared disk subsystem should be connected to all servers in the cluster (optional, but recommended for most configurations) and should be properly set up and functional according to the manufacturer's instructions.
- ♦ We recommend configuring the disks contained in the shared disk system to use mirroring or RAID to add fault tolerance to the shared disk system.
- ♦ At least 20 MB of free disk space on the shared disk system needs to be available for creating a cluster partition.

The Novell Cluster Services installation automatically allocates one cylinder on one drive of the shared disk system for the cluster partition. Depending on the location of the cylinder, the actual amount of space used by the cluster partition might be less than 20 MB.

- ♦ High-speed Fibre Channel cards, cables, and switch or SCSI cards and cables need to be installed to connect the servers to the shared disk subsystem.
 - ♦ If you are using a fibre channel SAN, the host bus adapters (HBAs) for each cluster node should be identical.
 - ♦ If you are using iSCSI for shared disk system access, make sure you have configured iSCSI initiators and targets prior to installing Novell Cluster Services.

- ♦ Novell Cluster Services software must be running on the OES server (SLES 10 and OES must be installed on every OES 2 server added to a cluster). You can install Novell Cluster Services and create a new cluster, or add a server to an existing cluster either during the SLES 10/OES installation or afterwards, using YaST.

See [“Installing Novell Cluster Services during a OES 2 Linux Installation”](#) and [“Installing Novell Cluster Services on an Existing OES 2 Linux Server”](#) in the *OES 2 SP3: Novell Cluster Services 1.8.8 Administration Guide for Linux*.

10.4 Caveats

There are several caveats that you need to be aware of:

- ♦ Resources created on OES cannot run on NetWare.
- ♦ You cannot add additional NetWare nodes to your cluster after adding a new OES node or changing an existing NetWare cluster node to an OES cluster node. If you want to add NetWare cluster nodes after converting part of your cluster to OES, you must first remove the OES nodes from the cluster.
- ♦ The server that holds the master eDirectory replica needs to be converted last, at the end of the rolling cluster conversion, not first.
- ♦ You can't change existing shared pools or volumes (storage reconfiguration) in a mixed NetWare/OES cluster. If you need to make changes to existing pools or volumes, you must temporarily bring down either all OES cluster nodes or all NetWare cluster nodes prior to making changes. Attempting to reconfigure shared pools or volumes in a mixed cluster can cause data loss.

10.5 Rolling Cluster Conversions

Performing a rolling cluster conversion from NetWare 6.5 to OES is one of the easier ways to upgrade Cluster Services to OES and keep your cluster up and running during the process.

In this method, one server is converted to OES while the other servers in the cluster continue running NetWare 6.5. Then, as needed, other nodes can be converted to OES incrementally until all servers in the cluster have been converted. Although it is feasible to use a mixed NetWare and OES cluster temporarily as an upgrade strategy, Novell does not recommend it as a permanent production implementation.

Refer to [“Converting NetWare 6.5 Clusters to OES 2 Linux”](#) in the *OES 2 SP3: Novell Cluster Services NetWare to Linux Conversion Guide* for instructions on performing a rolling cluster upgrade.

11 Upgrading Other Novell Products to OES

The information in this section was contributed by the GroupWise® and ZENworks® teams.

- ♦ [Section 11.1, “GroupWise 7 and GroupWise 8,” on page 93](#)
- ♦ [Section 11.2, “Identity Manager,” on page 97](#)
- ♦ [Section 11.3, “ZENworks,” on page 97](#)

11.1 GroupWise 7 and GroupWise 8

- ♦ [Section 11.1.1, “Source Platform Requirements,” on page 93](#)
- ♦ [Section 11.1.2, “Target Platform Requirements,” on page 93](#)
- ♦ [Section 11.1.3, “Preparing to Migrate,” on page 94](#)
- ♦ [Section 11.1.4, “Caveats,” on page 94](#)
- ♦ [Section 11.1.5, “Tool Options,” on page 94](#)
- ♦ [Section 11.1.6, “Migration Instructions,” on page 95](#)
- ♦ [Section 11.1.7, “Migrating GroupWise as Part of a Transfer ID Migration,” on page 95](#)
- ♦ [Section 11.1.8, “Additional Information,” on page 96](#)

11.1.1 Source Platform Requirements

You can migrate directly from any of the NetWare® platforms that support GroupWise 7 or GroupWise 8 as listed in the [GroupWise documentation \(http://www.novell.com/documentation/gwutilities/gw8_svrnig/data/b6ub1ga.html\)](http://www.novell.com/documentation/gwutilities/gw8_svrnig/data/b6ub1ga.html).

11.1.2 Target Platform Requirements

Although other supported platforms are listed in the [GroupWise documentation \(http://www.novell.com/documentation/gw8/gw8_admin_qs/data/gw8_admin_qs.html#aix5v8a\)](http://www.novell.com/documentation/gw8/gw8_admin_qs/data/gw8_admin_qs.html#aix5v8a), this guide focuses on migrating to OES 2.

For specific planning instructions, see the following information:

- ♦ **GroupWise 7:** “Planning Your Basic GroupWise System” (http://www.novell.com/documentation/gw7/gw7_install/data/a4bblzn.html) in the *GroupWise 7 Installation Guide* (http://www.novell.com/documentation/gw7/gw7_install/data/a20gkue.html).
- ♦ **GroupWise 8:** “Planning a Basic GroupWise System” (http://www.novell.com/documentation/gw8/gw8_install/data/a4bblzn.html) in the *GroupWise 8 Installation Guide* (http://www.novell.com/documentation/gw8/gw8_install/data/a20gkue.html).

11.1.3 Preparing to Migrate

Probably the most important tip to a successful migration is to make sure, before starting the migration, that the source NetWare server has the latest GroupWise support pack installed, and that GroupWise is running without problems.

The GroupWise documentation includes thorough migration planning instructions in “[Planning Your GroupWise Server Migration](http://www.novell.com/documentation/gwutilities/gw8_svrmig/data/b65pbe1.html)” (http://www.novell.com/documentation/gwutilities/gw8_svrmig/data/b65pbe1.html) in the *GroupWise Server Migration Utility Installation and Migration Guide* (http://www.novell.com/documentation/gwutilities/gw8_svrmig/data/ab32nt1.html).

11.1.4 Caveats

- ♦ **Earlier Version of GroupWise:** If you are running an earlier version of GroupWise on NetWare, you must upgrade to GroupWise 7 or GroupWise 8 with the latest support pack before migration to OES 2.
- ♦ **Migrating vs. installing GWIA and WebAccess:** Novell Support recommends deleting the NetWare-based GWIA and WebAccess objects and then installing new GWIA and WebAccess services on OES, even though there are instructions for migrating the GWIA and WebAccess services from NetWare to OES in the documentation.

11.1.5 Tool Options

You have two options for migrating GroupWise from NetWare to OES 2:

- ♦ **GroupWise Server Migration Utility:** This lets you identify the components (Post Office agents, etc.) to be migrated from NetWare to OES and then installs GroupWise, configures the agents, and migrates the data—all in real time. The process is flexible, allowing you to choose which components to migrate when.

During the initial transfer, the original server is maintained, letting you continue to run GroupWise on NetWare until the migration is complete and you are satisfied with the results.

After the initial transfer, the utility guides you through testing the system on the new OES server, and then when you are ready to switch, it migrates any data that was altered since the initial transfer and activates GroupWise on the OES server. This is the only point in the process when post office agents are taken down.

- ♦ **Manual Process:** Although it is much more involved and labor-intensive, some prefer to migrate GroupWise manually. The results are the same as the automated process, if all of the instructions are followed carefully.

Installation Is Included

Some administrators have incorrectly assumed that they must install GroupWise on the target server prior to the migration. Actually, GroupWise is installed on the OES 2 server as part of the migration.

Upgrading the GroupWise Version Is Not Included

You cannot upgrade GroupWise as part of the migration to OES. Specifically, you cannot migrate from GroupWise 7 on NetWare to GroupWise 8 on OES 2.

11.1.6 Migration Instructions

- ♦ “Manual Method” on page 95
- ♦ “Automated Method” on page 95

Manual Method

Table 11-1 Instructions for Manual GroupWise Migrations

GroupWise Version	See
GroupWise 7	“Migration” (http://www.novell.com/documentation/gw7/gw7_install/data/b2qqon2.html) in the <i>GroupWise 7 Installation Guide</i> (http://www.novell.com/documentation/gw7/gw7_install/data/a20gkue.html)
GroupWise 8	“Manual Migration Steps” (http://www.novell.com/documentation/gwutilities/gw8_svrmig/data/b2qqon2.html) in the <i>GroupWise Server Migration Utility Installation and Migration Guide</i> (http://www.novell.com/documentation/gwutilities/gw8_svrmig/data/ab32nt1.html)

Automated Method

Table 11-2 Instructions for an Automatic GroupWise Migration

GroupWise Version	See
GroupWise 7 and GroupWise 8	<i>GroupWise Server Migration Utility Installation and Migration Guide</i> (http://www.novell.com/documentation/gwutilities/gw8_svrmig/data/ab32nt1.html)

11.1.7 Migrating GroupWise as Part of a Transfer ID Migration

Migrating GroupWise as part of a Transfer ID migration is essentially a three-phase process.

- ♦ “Migrating GroupWise” on page 96
- ♦ “Verifying that the GroupWise Migration Succeeded” on page 96
- ♦ “Transferring the NetWare Server’s Identity” on page 96

Migrating GroupWise

If your NetWare server is currently running GroupWise, you must run the GroupWise Server Migration Utility before performing the Transfer ID migration.

The GroupWise Server Migration Utility does the following:

- ♦ It moves all GroupWise data and agents from a NetWare source server to an OES target server.
- ♦ It sets up the GroupWise Agents to run on the IP address and DNS name of the target OES server.

For instruction on running the GroupWise Server Migration Utility, see the *GroupWise Server Migration Utility 1.1 Installation and Migration Guide* (<http://www.novell.com/documentation/gwutilities/index.html>).

Verifying that the GroupWise Migration Succeeded

You should verify that GroupWise has migrated correctly and is running successfully for several weeks in the OES environment before completing the Identity Swap.

After the GroupWise migration, a copy of the GroupWise data is still located on the NetWare server. After you perform the Transfer ID migration, the GroupWise data is no longer accessible on the NetWare server.

Transferring the NetWare Server's Identity

- 1 In ConsoleOne, change the IP address or DNS names for the POA, WebAccess, and GWIA to reflect the NetWare server IP address or DNS information. This is only required for the agents that were transferred using the GroupWise Server Migration Utility.
- 2 Ensure that the changes have replicated through the system.
- 3 If a domain was transferred during the GroupWise Server migration, change the IP address or DNS name for the MTA.
- 4 Shut down the GroupWise agents running on the OES server.
- 5 Perform the Identity Swap.
- 6 After the Identity Swap has completed, bring up the GroupWise agents on the Linux server.

11.1.8 Additional Information

- ♦ Product Documentation:
 - ♦ [GroupWise 7](http://www.novell.com/documentation/gw7) (<http://www.novell.com/documentation/gw7>).
 - ♦ [GroupWise 8](http://www.novell.com/documentation/gw8) (<http://www.novell.com/documentation/gw8>).
 - ♦ [GroupWise Utilities Web page](http://www.novell.com/documentation/gwutilities/) (<http://www.novell.com/documentation/gwutilities/>).
- ♦ [Novell GroupWise Web site](http://www.novell.com/products/groupwise/) (<http://www.novell.com/products/groupwise/>)
- ♦ [Additional GroupWise articles](http://www.novell.com/products/groupwise/productinfo/) (<http://www.novell.com/products/groupwise/productinfo/>)

11.2 Identity Manager

For information about upgrading from NetWare to OES Linux, see [this Cool Solutions article \(http://www.novell.com/communities/node/6764/migration-identity-manager-351-netware-65-sp7-oes-2-sp1-linux\)](http://www.novell.com/communities/node/6764/migration-identity-manager-351-netware-65-sp7-oes-2-sp1-linux).

11.3 ZENworks

Many ZENworks features, such as policies and application distribution, are completely eDirectory™ and file system dependent. There is no dependency on the server OS. The remaining services that do have modules that run on a server, such as inventory and imaging, are dependent on a host OS.

11.3.1 Upgrading to ZENworks 10 Configuration Manager

ZENworks 10 Configuration Manager is fully supported on OES 2 SP2 and later. If you are running an older version of ZENworks on NetWare, the following guides will help you upgrade to ZENworks 10 running on OES 2 SP3.

- ♦ *ZENworks 10.1 Configuration Management ZENworks Migration Guide* (http://www.novell.com/documentation/zcm10/zcm10_zen_migration/data/bookinfo.html)

IMPORTANT: If you are upgrading using an Transfer ID migration, be sure to complete the upgrade to Linux before migrating to ZENworks 10.

11.3.2 Migrating ZENworks 7 from NetWare to Linux

The ZENworks 7 suite of products (except for ZENworks Middle Tier) is also fully tested and supported on the OES 2 SP2 and later platform.

For an example of migrating ZENworks 7 from NetWare to OES 2 SP3 by using the OES 2 SP3 Migration Tool, see [Section E.3, “Server Identity Migration,”](#) on page 122.

12 About Third-Party Applications

Two of the most important categories of third-party applications are anti-virus software and backup software.

Anti-Virus Software

For a current list of antivirus software vendors that support Novell Open Enterprise Server, see [Novell Open Enterprise Server Partner Support: Backup and Antivirus Support \(http://www.novell.com/products/openenterpriseserver/partners_communities.html\)](http://www.novell.com/products/openenterpriseserver/partners_communities.html). This list is updated quarterly.

IMPORTANT: If you run server-based anti-virus software, configure it so that it does not scan GroupWise directory structures such as domains and post offices where file locking conflicts can create problems for the GroupWise agents. If you need virus scanning on GroupWise data, check the [GroupWise Partner Products page \(http://www.novell.com/partnerguid/p100031.html\)](http://www.novell.com/partnerguid/p100031.html) for compatible products.

Backup Software

For a current list of backup software vendors that support Novell Open Enterprise Server, see [Novell Open Enterprise Server Partner Support: Backup and Antivirus Support \(http://www.novell.com/products/openenterpriseserver/partners_communities.html\)](http://www.novell.com/products/openenterpriseserver/partners_communities.html). This list is updated quarterly.

A Tools for Upgrading to OES 2 SP3

The following utilities are available to assist with migrations to OES 2 SP3. Each tool fulfills a specific migration or service-consolidation purpose as explained in the following sections:

- ◆ [Section A.1, “OES 2 SP3 Migration Tool,” on page 101](#)
- ◆ [Section A.2, “Server Consolidation and Migration Tool \(SCMT\),” on page 103](#)
- ◆ [Section A.3, “NetWare Migration Wizard,” on page 103](#)
- ◆ [Section A.4, “Additional Information,” on page 103](#)

A.1 OES 2 SP3 Migration Tool

The OES 2 SP3 Migration Tool is the main tool for upgrading from NetWare® to OES 2 SP3. The Migration Tool includes a consolidated GUI interface that lets you drag and drop the volumes and services that you want to migrate. Terminal commands are also provided for those who prefer to work at a terminal prompt (command line). Both the GUI and command line methods are documented in the [OES 2 SP3: Migration Tool Administration Guide](#).

The OES 2 SP3 Migration Tool runs exclusively on the destination OES server and pulls service configuration information and data from the NetWare source server. A Windows workstation is not required.

The OES 2 SP3 Migration Tool is installed on every OES 2 SP3 server.

When you run the GUI Migration Tool, after selecting the source and target servers, you are prompted to specify one of two migration types, as explained in the sections that follow.

- ◆ [Section A.1.1, “Consolidating Selected Data or Services,” on page 101](#)
- ◆ [Section A.1.2, “Transferring an Entire NetWare Server,” on page 102](#)
- ◆ [Section A.1.3, “More About Using the Migration Tool,” on page 102](#)

A.1.1 Consolidating Selected Data or Services

The first option is the Consolidate migration type.

Just as the name implies, a *Consolidate* migration is designed to migrate the services on multiple servers to a single, more powerful OES 2 SP3 server. However, the type is very adjustable, letting you specify only a single volume or service to migrate at a time. Obviously this lets you move data and services with absolute flexibility.

As with all migrations using the Migration Tool, the target server must be installed using the Pre-Migration Server installation pattern, and the patterns for the services you are planning to migrate to the server must be installed but not configured.

For more information on this type of migration, see [“Server Consolidations”](#) in the [OES 2 SP3: Migration Tool Administration Guide](#).

A.1.2 Transferring an Entire NetWare Server

The second option is the *Transfer ID* migration type.

This powerful functionality lets you transfer an existing NetWare server's identity, including its IP address, host name, eDirectory™ and security components, services, and data to an OES 2 SP3 server.

There are, of course, preparation steps to ensure that eDirectory and the NetWare server are healthy, and the services being migrated must be shut down during the migration process, but after the migration is finished, network users won't realize that anything has changed.

Those customers who have used this tool have been very pleased with the results.

For more information on this type of migration, see "[Transfer ID Migration](#)" in the *OES 2 SP3: Migration Tool Administration Guide*.

A.1.3 More About Using the Migration Tool

- ♦ "[Data Migration Support](#)" on page 102
- ♦ "[Batch Data Migration Support](#)" on page 102
- ♦ "[Service Migration Support](#)" on page 102
- ♦ "[eDirectory Migration Support](#)" on page 103

Data Migration Support

The primary purpose of the OES Migration Tool is to migrate data from the NetWare platform to the OES 2 platform. Data migration tools can also be used to migrate data from OES 1 servers and from Microsoft Windows servers. A good place to start is the *OES 2 SP3: Migration Tool Administration Guide*, which provides general information about moving data in the following sections:

- ♦ "[Migrating File System from NetWare, OES 1 or OES 2 to OES 2 SP3 Linux](#)"
- ♦ "[Migrating Data from Windows to OES 2 SP3 Linux](#)"

Batch Data Migration Support

If you want to migrate data from multiple NetWare servers to a single OES 2 SP3 server, you can create a cron job to automatically run multiple instances of the `migfiles` command sequentially. The Migration Tool GUI interface doesn't currently support batch migrations.

Service Migration Support

Information about transferring individual services is in "[Migration Scenarios](#)" in the *OES 2 SP3: Migration Tool Administration Guide*

In most cases, you first need to install the service on the OES 2 SP3 target server. Refer to the following sections in the *Migration Tool Administration Guide*:

- ♦ "[Migrating AFP from NetWare to OES 2 SP3 Linux](#)"
- ♦ "[Migrating Novell Archive and Version Services to OES 2 SP3 Linux](#)"
- ♦ "[Migrating CIFS from NetWare to OES 2 SP3 Linux](#)"
- ♦ "[Migrating DHCP from NetWare to OES 2 SP3 Linux](#)"
- ♦ "[Migrating DNS from NetWare to OES 2 SP3 Linux](#)"

- ♦ “[Migrating FTP from NetWare to OES 2 Linux](#)”
- ♦ “[Migrating iFolder 2.x](#)”
- ♦ “[Migrating iPrint from NetWare or OES 2 Linux to OES 2 SP3 Linux](#)”
- ♦ “[Migrating Timesync/NTP from NetWare to NTP on OES 2 Linux](#)”

eDirectory Migration Support

In OES 2, you migrate eDirectory using the new Identity Transfer functionality in the Migration Tool. See “[Migrating eDirectory to OES 2 SP3 Linux](#)” in the *OES 2 SP3: Migration Tool Administration Guide*.

A.2 Server Consolidation and Migration Tool (SCMT)

Support for migrating from newer NetWare platforms has not been removed from SCMT (as reflected in the *Novell Server Consolidation and Migration Toolkit Administration Guide*). However, Novell recommends using the OES 2 SP3 Migration Tool rather than SCMT when possible.

A.3 NetWare Migration Wizard

The primary purpose of the Novell® NetWare Migration Wizard is to migrate NetWare servers to new hardware or NetWare virtual machines.

When the migration is complete, the new server replaces and assumes the identity of the old server on the network.

IMPORTANT: For migrating to OES 2, use the new Identity Transfer feature found in the OES 2 SP3 Migration Tool. For more information, see “[Transfer ID Migration](#)” in the *OES 2 SP3: Migration Tool Administration Guide*.

A.4 Additional Information

- ♦ **Novell Upgrade or Migrate Web site.** For information on the tools and resources currently available from Novell, visit the [OES Upgrade or Migrate Web site \(http://www.novell.com/promo/upgradeormigrate.html\)](http://www.novell.com/promo/upgradeormigrate.html).
- ♦ **Links to Documentation.** For a complete list of links to data and service migration instructions in the OES 2 documentation, see the [Migrate, Consolidate, and Coexist \(http://www.novell.com/documentation/oes2/migrate-consolidate-coexist.html#migrate-consolidate-coexist\)](http://www.novell.com/documentation/oes2/migrate-consolidate-coexist.html#migrate-consolidate-coexist) page on the OES 2 Documentation Web site (<http://www.novell.com/documentation/oes2>).

B About the Management Tools in OES 2

- ♦ [Section B.1, “Novell iManager 2.7,” on page 105](#)
- ♦ [Section B.2, “Novell Remote Manager \(NRM\),” on page 106](#)
- ♦ [Section B.3, “About Other Management Tools,” on page 107](#)

B.1 Novell iManager 2.7

Novell® iManager is a Web-based administration console that provides secure, customized access to network administration utilities and content from virtually anywhere administrators have access to the Internet and a Web browser.

- ♦ [Section B.1.1, “What's New in Version 2.7,” on page 105](#)
- ♦ [Section B.1.2, “Supported Web Browsers,” on page 106](#)
- ♦ [Section B.1.3, “Caveats,” on page 106](#)
- ♦ [Section B.1.4, “Upgrading to iManager 2.7,” on page 106](#)

B.1.1 What's New in Version 2.7

Novell iManager 2.7 contains the following new features:

Tree View: The iManager tree view in the left navigation frame approximates functionality available in the ConsoleOne® Console View. You can navigate the tree structure, expanding and collapsing container objects as necessary. The right content frame displays contents and menu items for the object selected in the navigation frame.

File System Browse: iManager 2.7 lets you browse through an eDirectory™ Volume object to the underlying NCP™ enabled volume. Within the volume structure, you can select File and Directory objects. The actual tasks you can perform on file system objects is provided by the NSS iManager plug-in, which is available separately.

File system browsing does not support accessing the file system through NCP™ Server objects or NSS junction point objects.

File system browsing is available from the Object Selector, Object Browse, and Tree view, but is not available in Advanced Browsing mode. Also, file system browsing is not accessible from the Search or Advanced Search panes.

Available Novell Plug-in Modules: iManager 2.7 lists all the available iManager plug-ins contained in the packages directory/download site by default. You can download and install plug-ins from within iManager by querying the Novell download Web site. The previous versions of iManager listed only the updates to the installed plug-in modules.

NOTE: With NetWare, iManager 2.7 now requires and installs only Tomcat 5. However, OES 2 installs both Tomcat and Apache. iManager is supported only with the version of Tomcat that is installed with iManager.

B.1.2 Supported Web Browsers

- ◆ Microsoft IE 6 SP1 or later or IE 7
- ◆ Firefox* 1.5. x or 2. x

NOTE: You might be able to access iManager via a Web browser not listed, but Novell does not guarantee or support full functionality with any other browser.

B.1.3 Caveats

- ◆ In order for some iManager wizards and help to work, you must enable pop-up windows in your Web browser.
- ◆ iManager 2.7 can coexist in the same eDirectory tree with iManager 2.6.
- ◆ If your network has more than three servers, or one or more servers that do not host eDirectory replicas, you must have SLP properly configured for iManager to log in. For more information, see “SLP” in the *OES 2 SP3: Planning and Implementation Guide*.
- ◆ iManager 2.7 can manage any server running Novell eDirectory 8.6.2 or later.
- ◆ iManager 2.7 plug-ins are not compatible with previous versions of iManager. Additionally, any custom plug-ins you want to use with iManager 2.7 must be re-compiled in the iManager 2.7 environment.

B.1.4 Upgrading to iManager 2.7

In light of the [Caveats](#) mentioned above, Novell recommends that you simply install iManager 2.7 on your OES 2 servers and download all of the plug-ins that apply to your services. For more information, see the *Novell iManager 2.7 Installation Guide*.

B.2 Novell Remote Manager (NRM)

Novell Remote Manager for OES is a browser-based utility that can be used to manage one or more OES servers from a remote location to monitor server health, change the server configuration, or perform diagnostic and debugging tasks.

- ◆ It does not require a special client.
- ◆ It provides a graphical interface that makes interpreting diagnostic information much more comprehensive and easier to manage.
- ◆ It provides added functionality that is not available in other management utilities.
- ◆ [Section B.2.1, “Prerequisites,” on page 107](#)
- ◆ [Section B.2.2, “About Novell Remote Manager and OES 2,” on page 107](#)

B.2.1 Prerequisites

- ♦ OES services must be installed when you install the OES 2 server.
- ♦ Supported browsers include Mozilla* Firefox 1.0, Microsoft Internet Explorer 6 or later, Mozilla 1.7 (SLES 9 SP1 and Linux Professional 9.2), KDE 3.2 Konqueror (limited functionality), or Safari* 1.2 (limited functionality).
- ♦ The HTTPSTKD module must be loaded and running on the server. This module is selected, installed, and configured with a default configuration when you install any of the OES 2 patterns (unless you deselect it).

B.2.2 About Novell Remote Manager and OES 2

There is no need to migrate Novell Remote Manager (NRM) from NetWare to OES 2. Instead, this service can be installed when any Open Enterprise Server pattern is installed. Then, if you have created server groups for monitoring NetWare 6.5 servers, they can be accessed and monitored from Remote Manager on OES just as they can from a NetWare server running NetWare 6.0 or later.

However, NRM is configured somewhat differently on OES than on NetWare. When NRM is installed, it sets up a small Web server on the OES server. The interface and module is called HTTPSTKD. Basic configuration parameters are pre-set; however, these can be changed by editing the `httpstkd config` or `httpstkd PAM config` files. See [“Changing the Configuration”](#) in the *OES 2 SP3: Novell Remote Manager for Linux Administration Guide*.

You can log in as user Root, a local Linux user, or as an eDirectory user who is Linux User Management (LUM) enabled.

- ♦ If Linux User Management is enabled in your tree and is installed and configured on the local server, you can log in to Novell Remote Manager using your eDirectory credentials. See the *OES 2 SP3: Novell Linux User Management Administration Guide* for details.
- ♦ If you log in as a local Linux user or as a non-Admin eDirectory user, you can see only the information that the user you log in as has rights to view.

B.3 About Other Management Tools

[Section 3.1.3, “About eDirectory Management Tools in OES 2,”](#) on page 35 discusses additional management tools in OES 2, especially those for eDirectory.

C Workstation Considerations

There are some impacts on network workstations resulting from a migration to OES 2.

Domain Services for Windows

Domain Services for Windows (DSfW) provides Windows users with seamless integration between eDirectory™ and Active Directory. For an overview of this new functionality, see [Section 3.5, “About Domain Services for Windows,”](#) on page 42.

Novell Client

As OES 2 is implemented, existing clients can be used (Windows XP, 2000, NT, Vista). However, an upgrade to the latest clients and workstation OS is required to take full advantage of the new features of eDirectory and OES 2, such as NMASTM and Password Self Service.

iFolder

The iFolder client must be installed on all Macintosh, Linux, and Windows workstations that use this functionality in OES 2.

iPrint

The iPrint agent must also be installed on all Macintosh, Linux, and Windows workstations that use this functionality in the OES 2 environment.

D Server Consolidation

The OES 2 SP3 Migration Tool includes a Consolidate migration type that is specifically designed to support server consolidation. For more information, see [Section A.1.1, "Consolidating Selected Data or Services,"](#) on page 101.

E Examples

This section contains a few real-world examples of upgrades to OES 2 that Novell® customers have done. If you have an example you want to share, please submit a User Comment for this page with your e-mail address, and we'll contact you.

- ♦ [Section E.1, "Replica and CA Server Migration," on page 113](#)
- ♦ [Section E.2, "Cluster Migration," on page 115](#)
- ♦ [Section E.3, "Server Identity Migration," on page 122](#)

E.1 Replica and CA Server Migration

The following is an example of transferring a NetWare® 6.5 SP7 CA and eDirectory™ replica server to an OES 2 server using the Transfer ID option in the OES 2 SP3 Migration Tool.

- ♦ [Section E.1.1, "Overview," on page 113](#)
- ♦ [Section E.1.2, "FAQs," on page 114](#)
- ♦ [Section E.1.3, "Preparing and Transferring Your Replica Server," on page 114](#)
- ♦ [Section E.1.4, "Post-Migration Configuration," on page 115](#)

E.1.1 Overview

Table E-1 Service Migration Summary

Pre-Migration	Post-Migration
A NetWare 6.5 SP7 server running as the master replica server and certificate authority for the eDirectory tree.	A single OES 2 server running as the master replica server and certificate authority for the eDirectory tree.
This server currently provides these services:	The server has the same name and IP address as the NetWare server.
<ul style="list-style-type: none">♦ SLPDA♦ iManager♦ VLDB (DFS)♦ NetStorage♦ LDAP	This server provides these services: <ul style="list-style-type: none">♦ SLPDA♦ iManager♦ VLDB (DFS)♦ NetStorage♦ LDAP♦ NTP

E.1.2 FAQs

- ♦ **Q:** Do we need to remove the Certificate Authority and create a new one on the new server?
A: No. The Identity Transfer option migrates the existing eDirectory Certificate Authority to the new server.
- ♦ **Q:** To migrate the master, do we need to remove all eDirectory replicas, remove the server from eDirectory, build a new server with the same name, add replicas back, etc.?
A: No. The Identity Transfer option migrates the existing eDirectory database to the new server.

E.1.3 Preparing and Transferring Your Replica Server

- 1 Prepare your servers by following the instructions in “[Preparing for Transfer ID](#)” in the *OES 2 SP3: Migration Tool Administration Guide*.

Make sure you do the following:

- ♦ Install the OES target server in the same context as the NetWare source server, using the *Novell Pre-Migration Server* pattern and the patterns for all services that correspond to the services running on the NetWare server.

This ensures that eDirectory is installed on the target server without a replica and that the target server is prepared for all of the services being migrated.

IMPORTANT: You must select the "Pre-Migration Server" install pattern during the initial OES installation. Otherwise, an eDirectory replica is installed and/or configured on the server, and the server is not a valid migration target server.

Selecting the pattern later will not remove the replica configuration.

If you install a server without selecting the pre-migration pattern initially, you must start fresh by performing a *New Server* installation and being sure to select *Pre-Migration Server* as one of the initial OES patterns.

For instructions, see “[Installing OES 2 SP3 as a New Installation](#)” in the *OES 2 SP3: Installation Guide*.

- ♦ If you are moving data from NSS volumes on the NetWare source server, create corresponding NSS volumes on the OES target server. Be sure to use the same names as on the source server.
Do not create any new volumes that will not have data migrated to them until after the Identity Transfer migration is completed.
 - ♦ Verify that the host name and DNS entries in your local `/etc/hosts` files and on the DNS server are correct.
 - ♦ Apply the latest SLES 10 SP4 and OES 2 SP3 patches from the Novell Customer Center to the target server. For more information, see “[Updating \(Patching\) an OES 2 SP3 Server](#)” in the *OES 2 SP3: Installation Guide*.
 - ♦ If the source server is running NetWare 6.5 SP7, install the [SMS patch](http://support.novell.com/docs/Readmes/InfoDocument/patchbuilder/readme_5042400.html) first. If the source server is running SP8, this is not necessary.
- 2 Migrate your server by following the instructions in “[Using the Migration GUI Tool for Transfer ID](#)” in the *OES 2 SP3: Migration Tool Administration Guide*.

Make sure you do the following:

- ♦ If you are moving data from NSS volumes on the NetWare source server, follow the instructions in “[Migrating File System from NetWare, OES 1 or OES 2 to OES 2 SP3 Linux](#)” in the *OES 2 SP3: Migration Tool Administration Guide*.
- ♦ Do not select iManager, VLDB, NetStorage or LDAP for migration. These services work automatically after the ID Transfer is complete.
- ♦ SLPDA must be manually reconfigured after the migration completes.

E.1.4 Post-Migration Configuration

- 1 Set up the SLP DA on your OES server by following the instructions in “[Setting Up an OpenSLP DA Server](#)” in the *OES 2 SP3: Planning and Implementation Guide*.
- 2 Clean up the old eDirectory target server objects by following the instructions in “[Cleanup Objects](#)” in the *OES 2 SP3: Migration Tool Administration Guide*.
- 3 If you have DFS junctions, check one of them in this VLDB management context to make sure it is still working. If it is not working, rebuild the VLDB using the instructions in “[Repairing the VLDB](#)” in the *OES 2 SP3: Novell Distributed File Services Administration Guide for Linux*.
- 4 For information about time synchronization services on a Novell network, see “[Time Services](#)” in the *OES 2 SP3: Planning and Implementation Guide*.
- 5 Verify that all of the other services are working as expected.

E.2 Cluster Migration

The following is an example of doing a rolling cluster upgrade from an NetWare 6.5 SP7 cluster to an OES 2 SP3 cluster.

- ♦ [Section E.2.1, “Overview,”](#) on page 115
- ♦ [Section E.2.2, “General Notes and Tips,”](#) on page 116
- ♦ [Section E.2.3, “Preparing to Migrate the Cluster,”](#) on page 116
- ♦ [Section E.2.4, “Transferring DHCP in the Cluster,”](#) on page 117
- ♦ [Section E.2.5, “Transferring DNS in a Cluster,”](#) on page 118
- ♦ [Section E.2.6, “iPrint Migration in a Cluster,”](#) on page 120
- ♦ [Section E.2.7, “Transferring AFP in a Cluster,”](#) on page 122
- ♦ [Section E.2.8, “Transferring CIFS in a Cluster,”](#) on page 122

E.2.1 Overview

[Table E-2](#) summarizes the pre-migration and post-migration status of the cluster being migrated.

Table E-2 Service Migration Summary

Pre-Migration: Three-node NetWare 6.5 SP7 Cluster	Post-Migration: Three-node OES 2 SP3 Cluster
Each node contains some eDirectory replicas	Each node contains some eDirectory replicas

Pre-Migration: Three-node NetWare 6.5 SP7 Cluster	Post-Migration: Three-node OES 2 SP3 Cluster
Each node has access to fiber-attached shared storage that includes:	Each node has access to fiber-attached shared storage that includes:
<ul style="list-style-type: none"> ◆ Several clustered NSS volumes for home directories and shared file systems ◆ One clustered NSS volume for NDPS and iPrint ◆ Clustered DHCP ◆ Clustered DNS ◆ Clustered AFP (NFAP) ◆ Clustered CIFS (NFAP) 	<ul style="list-style-type: none"> ◆ Several clustered NSS volumes for home directories and shared file systems ◆ One clustered NSS volume for iPrint ◆ Clustered DHCP ◆ Clustered DNS ◆ Clustered Novell AFP ◆ Clustered Novell CIFS

E.2.2 General Notes and Tips

- ◆ In the YaST install, clustering is disabled by default. To set up clustering, you must enable it for configuration. See “[Novell Cluster Services Parameters and Values](#)” in the *OES 2 SP3: Installation Guide*.
- ◆ Clustering on OES 2 SP3 is case-sensitive. Always make sure that you have specified the correct case for each name, etc. The SPD on the OES node is created exactly as you specify it. (NetWare was case-insensitive.)
- ◆ NetWare cluster names display in uppercase. Using lowercase for OES cluster names makes them easier to distinguish from the NetWare names.
- ◆ On NetWare nodes, the load and unload scripts are stored in eDirectory and accessible through iManager.
- ◆ On OES nodes, the load and unload scripts are dynamically created in `/var/run/ncs` from the scripts stored in eDirectory each time that you cluster-migrate a cluster resource to the OES node.
Scripts are retained only while the OES server is running. If the server goes down for any reason, the scripts are removed. This is not a problem, however, because they are created again when you cluster-migrate the cluster resources.
- ◆ NetWare has a limitation of 1024 characters in scripts. Linux doesn't have this limitation.
The best solution for this limitation is to create a small script to call the larger scripts. The script must be the same on each box. [Section E.2.4, “Transferring DHCP in the Cluster,”](#) on page 117 illustrates this concept.
- ◆ There's a utility called `sbdutil` that lets you manage the `sbd` on OES. For documentation, access the `sbdutil` man page on a clustered server.

E.2.3 Preparing to Migrate the Cluster

- 1 Read through [Table E-3](#) to understand what happens to the existing volumes during a cluster migration.

Table E-3 What Happens to Existing Volumes During a Cluster Migration

Pre-Migration Status	Migration Action	Post-Migration Status
Users volume active on NetWare	Cluster-migrates to an OES node	Users volume active on OES
Shared volume active on NetWare	Cluster-migrates to an OES node	Shared volume active on OES
NDPS volume active on NetWare	Migration Tool migrates configuration, etc. to the new iPrint volume.	Offline
DNS volume active on NetWare	Moved by iManager to the new DNS2 volume on OES.	Offline

- 2 Create all of the NSS volumes that are required for your service migrations as listed in [Table E-3](#).

WARNING: This must be done while the cluster has only NetWare nodes. If you have already joined OES nodes to your cluster, make sure that you remove them from the cluster before you create the NSS volumes.

Table E-4 New NSS Pools and Volumes Are Required

Create These	Migration Action	Post-Migration Status
Destination iPrint pool and volume (newly created through the NetWare server)	Cluster-migrates to an OES node	iPrint volume active on OES
Destination DHCP pool and volume (newly created through the NetWare server)	Cluster-migrates to an OES node	DHCP volume active on OES
Destination DNS2 pool and volume (newly through the NetWare server).	Cluster-migrates to an OES node	DNS2 volume active on OES

E.2.4 Transferring DHCP in the Cluster

- 1 Before starting the migration, create the Destination DHCP volume specified in [Table E-4](#).
- 2 Add one or more OES 2 SP3 servers to the cluster. For more information, see “[Adding New OES 2 Linux Nodes to Your NetWare Cluster](#)” in the *OES 2 SP3: Novell Cluster Services 1.8.8 Administration Guide for Linux*.
- 3 Set up an OES DHCP cluster resource using the instructions in the first three section only of “[Installation and Configuration](#)” in the *OES 2 SP3: Novell DNS/DHCP Administration Guide*.
- 4 Edit the destination DHCP pool resource load script and insert the following line just before the last (`exit 0`) line:

```
/destination_dhcp_volume/dhcp_cluster.sh
```

where `destination_dhcp_volume` is the path to the destination DHCP volume listed in [Table E-3](#).

For example, insert the following line:

```
/media/nss/DHCP_VOLUME/dhcp_cluster.sh
```

IMPORTANT: This step is required to circumvent the 1024 byte script-size limitation on NetWare mentioned in [Section E.2.2, “General Notes and Tips,”](#) on page 116.

- 5 Download the `dhcp_cluster.sh` (http://www.novell.com/documentation/oes2/scripts/dhcp_cluster.sh) script file from the OES 2 Documentation Web site.
- 6 Using a UNIX-compatible text editor, replace `<DHCP_VOLUME>` in the `dhcp_cluster.sh` script with the local mount point of your destination DHCP volume.
For example, `MOUNT_POINT="/media/nss/DHCP_VOLUME"`.
- 7 Using the instructions in “[Migrating DHCP from NetWare to OES 2 SP3 Linux](#)” in the *OES 2 SP3: Migration Tool Administration Guide*, migrate the NetWare DHCP configuration to one of the OES servers added to the cluster in [Step 2](#).
- 8 Copy the `/etc/dhcpd.conf` file to the destination DHCP volume.
For example `cp /etc/dhcpd.conf /media/nss/DHCP_VOLUME/dhcpd.conf`.
- 9 Edit the `dhcpd.conf` file you copied in [Step 8](#), as follows:
 - 9a Change the `ldap-server` IP address to the IP address associated with your destination DHCP pool.
 - 9b Change the `ldap-dhcp-server-cn` to the OES DHCP Server Object created by the Migration Tool in [Step 7](#).
- 10 Copy the `migrated_server.leases` file from the `/var/opt/novell/dhcp/leases` folder to the `/var/lib/dhcp/db` folder on your Destination DHCP Volume and rename it to `dhcpd.leases`.
Continuing with the same example, you use the following command to copy and rename the file:

```
cp /var/opt/novell/dhcp/leases/DHCP_SERVER.leases /media/nss/DHCP_VOLUME/var/lib/dhcp/db/dhcpd.leases
```
- 11 Offline the DHCP cluster resource that has been running on NetWare.
- 12 Online the OES DHCP cluster resource.
- 13 (Optional) Use iManager to enable the DHCP server as the authoritative server.

E.2.5 Transferring DNS in a Cluster

- ♦ “[Using iManager to Migrate DNS Servers within the Same eDirectory Tree](#)” on page 118
- ♦ “[Installing and Configuring a Cluster-Enabled DNS](#)” on page 119

Using iManager to Migrate DNS Servers within the Same eDirectory Tree

- 1 Before starting the migration, create the Destination DNS2 volume specified in [Table E-4](#).
- 2 Launch iManager.
- 3 Identify the source NCP™ server object and the corresponding DNS server object to be migrated to the OES 2 SP3 target server.
- 4 Unload the source DNS Server use the following command:

```
unload named.nlm
```
- 5 In iManager, click *DNS > DNS Server Management*.
- 6 Select *Move DNS Server* from the drop-down menu and click *OK*.
- 7 In the *Select DNS Server Name* field, select the source NetWare DNS Server name.

- 8 In the *Enter NCP server Name* field, browse and select the virtual cluster NCP server object that represents the destination DNS2 pool.
- 9 Click *Move*.
- 10 Click *OK*.
- 11 Use the following command to load the newly migrated DNS server on the target OES 2 SP3 server:

```
rcnovell-named start
```
- 12 Query the New DNS server for the zones and rr requests, ensure that all the associated zones are served and that the server roles are maintained on the zone.

IMPORTANT: If you are not able to locate the DNS servers, make sure that the scope settings point to the correct context for the DNS/DHCP locator object.

Installing and Configuring a Cluster-Enabled DNS

- 1 Verify that all OES 2 SP3 cluster nodes have the DNS pattern installed with a common locator group context.
- 2 Mount the shared volume on one of the OES 2 SP3 nodes in the cluster.
- 3 Execute the following script at the command prompt:

```
/opt/novell/named/bin/ncs_dir.sh mount_point username
```

where *mount_point* is the Destination DNS2 volume listed in [Table E-4](#) and *username* is the fully distinguished name of the DNS user (named by default).

For example, you might enter the following command:

```
/opt/novell/named/bin/ncs_dir /media/nss/DNSVOL/ cn=named.o=novell.T=MyTree
```

The script creates the following directory:

```
/media/nss/DEST_DNS2_VOL/etc/opt/novell/named
```

The script also assigns access and ownership rights for the preceding directory to the DNS user.

- 4 Run the DNS Server by using the following command:

```
/opt/novell/named/bin/novell-named -u DNS_User -V DEST_DNS2_VOL
```

 This step ensures that DNS server is running on the cluster node.
- 5 Click *Cluster > Cluster Options*, then select the Destination DNS2 cluster pool resource and click *Details*.
- 6 Click the *Scripts* tab.
 - 6a Click *Load Script*.
 - 6b Add following line before `exit 0` to load DNS.

```
exit_on_error /opt/novell/named/bin/novell-named -u DNS_User -V DESTINATION_DNS2_VOLUME
```
 - 6c Click *Unload Script*.
 - 6d Add following line at the beginning to unload DNS.

```
killproc -p /var/opt/novell/run/named/named.pid -TERM /opt/novell/named/bin/novell-named
```
- 7 Set the Destination DNS2 cluster resource offline and then online by using the *Clusters > Cluster Manager* task in iManager.
- 8 Verify that DNS services are functioning correctly.

E.2.6 iPrint Migration in a Cluster

- ♦ “How Clustered iPrint Migration Works” on page 120
- ♦ “Tips and Caveats” on page 120
- ♦ “Transferring iPrint in a Cluster” on page 120

How Clustered iPrint Migration Works

The OES 2 SP3 Migration Tool (miggui) contains an NLM™ named `PSMINFO.NLM` that copies all of the iPrint data from the cluster to an XML text file named `psminfo.xml` on the iPrint NSS volume that you created in [Step 2 on page 117](#). The `psminfo.xml` file is located in an `/ndps` directory at the root of the volume.

The migration tool uses the information in `psminfo.xml` to create new printer objects, set up the driver store, create printer agents, etc. The tool also changes the names of the old iPrint objects in eDirectory by appending `_nw` to each name. The old names can then be applied to the new printer objects. All changes are completely transparent to iPrint users.

Tips and Caveats

- ♦ Legacy queue-based printing cannot be serviced by an OES 2 Printer Agent.
- ♦ You can manage both OES iPrint and NetWare iPrint from NetWare, but you can only manage OES iPrint from OES.
- ♦ You must create the iPrint NSS pool and volume as instructed in [Step 2 on page 117](#) prior to adding OES nodes to the cluster or running the migration.

Transferring iPrint in a Cluster

- 1 Download the `iprint_load.sh` script (http://www.novell.com/documentation/oes2/scripts/iprint_load.sh) and the `iprint_unload.sh` script (http://www.novell.com/documentation/oes2/scripts/iprint_unload.sh) from the OES 2 Documentation Web site.
- 2 Customize the iPrint load script for your iPrint pool resource by doing the following:
 - 2a In iManager, access the load script for the destination iPrint pool resource.
 - 2b Copy and paste the contents of the downloaded `iprint_load.sh` file below the last line of the current load script.
 - 2c Using the information in the current script, replace each variable (indicated by `<angle brackets>`) with the correct values for the cluster resource.

For example, if the first line in the current script reads

```
nss /poolactivate=POOLNAME
```

Modify the third line in the downloaded script to read

```
exit_on_error nss /poolact=POOLNAME
```
 - 2d Remove all of the lines down to the first line you inserted.
 - 2e Click *Apply*.
- 3 Customize the iPrint unload script for your iPrint pool resource by doing in the following:
 - 3a In iManager, access the unload script for the destination iPrint pool resource.
 - 3b Copy and paste the contents of the downloaded `iprint_unload.sh` file below the last line of the current unload script.

- 3c** Using the information in the current script, replace each variable (indicated by <angle brackets>) with the correct values for the cluster resource.

For example, if the first line in the current script reads

```
ncpcon unbind
--ncpservname=CLUSTERNAME_POOLNAME_SERVER --ipaddress=192.168.10.10
```

Modify the third line in the downloaded script to read

```
ignore_error ncpcon unbind
--ncpservname=CLUSTERNAME_POOLNAME_SERVER --ipaddress=192.168.10.10
```

- 3d** Remove all of the lines down to the first line you inserted.

3e Click *Apply* > *OK*.

- 4** In *iManager* > *Cluster Options*, select the iPrint cluster resource object and click the *Details* link.
- 5** On the Cluster Pool Properties page, click the *Preferred Nodes* tab and move all of the NetWare nodes to the *Unassigned* column.

- 6** Offline and then online the cluster resource.

- 7** On the server where the iPrint cluster resource is running, open a terminal and enter the following commands:

```
cd /opt/novell/iprint/bin
./iprint_nss_relocate -a admin.fqdn -p password -n NSS/path -l cluster
```

For example, enter

```
./iprint_nss_relocate -a cn=admin,o=novell -p novell -n /media/nss/NSSVOLNAME -
l cluster
```

- 8** Migrate the iPrint resource to another OES 2 SP3 node in the cluster, then repeat [Step 7](#) until all of the OES 2 SP3 nodes in the cluster have run the `iprint_nss_relocate` script.
- 9** Create the Print Manager and Driver Store on the OES cluster.

When choosing the target server, use the IP address of the cluster resource. This specifies where the driver store and Print Manager database will reside. Begin by using the IP address of the new resource. This will need to be changed to a DNS name later by editing the `.conf` file.

When you receive a certificate management error, allow the error and proceed.

While you are creating the Print Manager, the lower dialog box indicates where the Print Manager will be located. Specify the IP address of the cluster resource. This changes later to a DNS name.

The iPrint service doesn't "know" that it's running on a cluster because the script creates a symbolic link. If the link exists, you know that the service is clustered.

- 10** After you create the Print Manager and Driver Store, modify the `/etc/opt/novell/iprint/conf/ipsmd.conf` and `idsd.conf` to have multiple `DSServer` values.

For example:

```
DSServer1 replicaServer
```

```
DSServer2 replicaServer
```

```
DSServer3 replicaServer
```

- 11** Remove the pound sign (#) from the following two lines in the load script:

```
exit_on_error rcnovell-idsd start
exit_on_error rcnovell-ipsmd start
```

- 12** Offline and online the cluster resource and verify that the Print Manager and Driver Store load.

- 13 Create a printer to test that the service is working.
- 14 Follow the instructions in “[Migrating iPrint from NetWare or OES 2 Linux to OES 2 SP3 Linux](#)” in the *OES 2 SP3: Migration Tool Administration Guide*.

IMPORTANT: When you authenticate to the source and target servers, use the IP address of the source Novell Cluster Services™ iPrint resource (secondary IP) and the IP address of the target Novell Cluster Services iPrint resource (secondary IP).

The `ipsmd.conf` file is located in the `/etc/opt/novell/iprint/conf` directory.

E.2.7 Transferring AFP in a Cluster

- 1 Install AFP on each OES 2 SP3 server that will be in the cluster. For details, see the [OES 2 SP3: Novell AFP For Linux Administration Guide](#).
- 2 Cluster-enable the AFP service. For details, see “[Configuring AFP with Novell Cluster Services for an NSS File System](#)” in the *OES 2 SP3: Novell AFP For Linux Administration Guide*.

E.2.8 Transferring CIFS in a Cluster

- 1 Install CIFS on each OES 2 SP3 server that will be in the cluster. For details, see the [OES 2 SP3: Novell CIFS for Linux Administration Guide](#).
- 2 Cluster-enable the CIFS service. For details, see “[Configuring CIFS with Novell Cluster Services for an NSS File System](#)” in the *OES 2 SP3: Novell CIFS for Linux Administration Guide*.

E.3 Server Identity Migration

The following is an example of transferring a NetWare 6.5 SP7 server to an OES 2 SP3 server, using the Transfer ID option in the OES 2 SP3 Migration Tool.

- ◆ [Section E.3.1, “Preparing and Transferring Your Replica Server,”](#) on page 123
- ◆ [Section E.3.2, “Post-Migration Steps,”](#) on page 124

Table E-5 Service Migration Summary

Pre-Migration (Source Server)	Post-Migration (Target Server)
A NetWare 6.5 SP7 server with the following: <ul style="list-style-type: none"> ◆ eDirectory replicas ◆ NSS volumes for home directories and shared file systems ◆ An NSS volume for NDPS and iPrint ◆ DHCP services ◆ ZENworks® for Desktops 7 SP1 IR3a HP3 (or newer update) 	An OES 2 SP3 server on new hardware with the same name and eDirectory identity <ul style="list-style-type: none"> ◆ eDirectory replicas ◆ NSS volumes for home directories and shared file systems ◆ An NSS volume for iPrint ◆ DHCP services ◆ ZENworks for Desktops 7 SP1 IR3a HP3 (or newer update)

E.3.1 Preparing and Transferring Your Replica Server

- 1 Prepare your servers by following the instructions in “[Preparing for Transfer ID](#)” in the *OES 2 SP3: Migration Tool Administration Guide*.

Make sure you do the following:

- ♦ Install the OES target server in the same context as the NetWare source server, using the *Novell Pre-Migration Server* pattern and the patterns for all services that correspond to the services running on the NetWare server.

This ensures that eDirectory is installed on the target server without a replica and that the target server is prepared for all of the services being migrated.

For instructions, see “[Installing OES 2 SP3 as a New Installation](#)” in the *OES 2 SP3: Installation Guide*.

- ♦ If you are moving data from NSS volumes on the NetWare source server, create corresponding NSS volumes on the OES target server. Be sure to use the same names as on the source server.

Do not create any new volumes that will not have data migrated to them until after the Identity Transfer migration is completed.

- ♦ Verify that the host name and DNS entries in your local `/etc/hosts` files and on the DNS server are correct.
- ♦ Apply the latest SLES 10 SP4 and OES 2 SP3 patches from the Novell Customer Center to the target server. For more information, see “[Updating \(Patching\) an OES 2 SP3 Server](#)” in the *OES 2 SP3: Installation Guide*.
- ♦ If the source server is running NetWare 6.5 SP7, install the [SMS patch \(http://support.novell.com/docs/Readmes/InfoDocument/patchbuilder/readme_5042400.html\)](http://support.novell.com/docs/Readmes/InfoDocument/patchbuilder/readme_5042400.html) first. If the source server is running SP8, this is not necessary.
- ♦ If you are migrating ZENworks 7 Server Management, delete the Distributor and Subscriber objects on the NetWare servers that will be migrated to OES 2 SP3.

- 2 Migrate your server by following the instructions in “[Using the Migration GUI Tool for Transfer ID](#)” in the *OES 2 SP3: Migration Tool Administration Guide*.

Make sure you do the following:

- ♦ If you are moving data from NSS volumes on the NetWare source server, follow the instructions in “[Migrating File System from NetWare, OES 1 or OES 2 to OES 2 SP3 Linux](#)” in the *OES 2 SP3: Migration Tool Administration Guide*.
 - ♦ If you are migrating Novell ZENworks 7 Desktop Management, migrate the directories where you store your MSI, AOT, etc. You do not need to migrate the ZENworks program directory itself.
 - ♦ If you are migrating Novell ZENworks 7 Server Management, migrate the directories where you store your user applications, etc.
- ♦ If you are transferring iPrint, follow the instructions in “[Migrating iPrint from NetWare or OES 2 Linux to OES 2 SP3 Linux](#)” in the *OES 2 SP3: Migration Tool Administration Guide*. Do not perform the post-migration procedures at this point.
- ♦ If you are transferring DHCP, follow the instructions in “[Migrating DHCP from NetWare to OES 2 SP3 Linux](#)” in the *OES 2 SP3: Migration Tool Administration Guide*. Do not perform the post-migration procedures at this point.

- 3 After all the services above have been successfully migrated, click the button to transfer the server identity and complete the Transfer ID Wizard.

E.3.2 Post-Migration Steps

- ♦ “iPrint” on page 124
- ♦ “DHCP” on page 124
- ♦ “ZENworks 7” on page 124

iPrint

- 1 Complete the remaining iPrint instructions, starting with “[Migrating ZENworks iPrint Policies](#)” in the *OES 2 SP3: Migration Tool Administration Guide*.

DHCP

- 1 Complete the remaining iPrint instructions, starting with “[Post-Migration Procedures](#)” in the *OES 2 SP3: Migration Tool Administration Guide*.

ZENworks 7

- ♦ “[Novell ZENworks 7 Desktop Management](#)” on page 124
- ♦ “[Novell ZENworks 7 Server Management](#)” on page 124

IMPORTANT: You need the ZENworks for Desktops 7 SP1 IR3a HP4 patch for imaging on 64bit Linux .

Novell ZENworks 7 Desktop Management

1. Mount the ZENworks 7 Desktop Management Linux CD on the OES 2 SP3 server.
2. Install ZENworks 7 Desktop Management, selecting the features that you will use.
You can also do the silent install by modifying the `silent.properties` file and copying it to your machine.
3. Modify each NAL object to reflect the new path to the files on the OES Volume
4. Modify the Workstation objects so that they have the correct location for the images.
5. Open the ports in the firewall on the OES 2 SP3 server.
See “[Ports used by ZEN](http://www.novell.com/support/php/search.do?cmd=displayKC&docType=kc&externalId=3880659&sliceId=1&docTypeID=DT_TID_1_1&dialogID=22570644&stateId=1%20%2022568512)” (http://www.novell.com/support/php/search.do?cmd=displayKC&docType=kc&externalId=3880659&sliceId=1&docTypeID=DT_TID_1_1&dialogID=22570644&stateId=1%20%2022568512)

Novell ZENworks 7 Server Management

1. Install ZENworks 7 Server Management on the OES 2 SP3 server
2. Make sure that the Distributor and Subscriber objects are created.

IMPORTANT: If you did not delete the objects before the migration ([Step 1 on page 123](#)), you get an error and they are not created. In this case, all of the paths still point to the NetWare volumes and ZENworks 7 Server Management does not function properly.

3. Resolve the certificates by using ConsoleOne®.
4. Right-click any of the distributions that you created and assign them to the new distributor created when you installed ZENworks 7 Server Management on the server.

5. Access the Distributions that have paths, and modify them with the new paths.
6. If you were using variables, access the Subscriber and re-create the variables, making sure they point to the new location on the OES 2 SP3 server.
7. Open the ports in the firewall on the OES 2 SP3 server.
See “Ports used by ZEN” (http://www.novell.com/support/php/search.do?cmd=displayKC&docType=kc&externalId=3880659&sliceId=1&docTypeID=DT_TID_1_1&dialogID=22570644&stateId=1%20%2022568512)

F Documentation Updates

This section summarizes the changes made to this guide since its initial release.

January 21, 2013

Chapter or Section Changed	Summary of Changes
Various	Addressed various user comments.

January 18, 2012

Chapter or Section Changed	Summary of Changes
Various	Updated format to comply with new corporate standard.

September 5, 2011

Chapter or Section Changed	Summary of Changes
Various	Updated to reflect support for SLES 10 SP4 as the base platform for OES 2 SP3.

June 3, 2011

Chapter or Section Changed	Summary of Changes
Section 2.2.4, "File System Considerations," on page 30	Updated the information about GroupWise recommendations.

December 21, 2010

Chapter or Section Changed	Summary of Changes
Various	Made changes throughout to update links and correct version information for the SP3 release.

