

Novell NetWare 6

www.novell.com

OVERVIEW AND INSTALLATION GUIDE

100-004725-001



Novell®

Legal Notices

Novell, Inc. makes no representations or warranties with respect to the contents or use of this documentation, and specifically disclaims any express or implied warranties of merchantability or fitness for any particular purpose. Further, Novell, Inc. reserves the right to revise this publication and to make changes to its content, at any time, without obligation to notify any person or entity of such revisions or changes.

Further, Novell, Inc. makes no representations or warranties with respect to any software, and specifically disclaims any express or implied warranties of merchantability or fitness for any particular purpose. Further, Novell, Inc. reserves the right to make changes to any and all parts of Novell software, at any time, without any obligation to notify any person or entity of such changes.

This product may require export authorization from the U.S. Department of Commerce prior to exporting from the U.S. or Canada.

Copyright © 2002 Novell, Inc. All rights reserved. No part of this publication may be reproduced, photocopied, stored on a retrieval system, or transmitted without the express written consent of the publisher.

U.S. Patent No. 5,157,663; 5,349,642; 5,455,932; 5,553,139; 5,553,143; 5,572,528; 5,594,863; 5,608,903; 5,633,931; 5,652,859; 5,671,414; 5,677,851; 5,692,129; 5,701,459; 5,717,912; 5,758,069; 5,758,344; 5,781,724; 5,781,724; 5,781,733; 5,784,560; 5,787,439; 5,818,936; 5,828,882; 5,832,274; 5,832,275; 5,832,483; 5,832,487; 5,850,565; 5,859,978; 5,870,561; 5,870,739; 5,873,079; 5,878,415; 5,878,434; 5,884,304; 5,893,116; 5,893,118; 5,903,650; 5,903,720; 5,905,860; 5,910,803; 5,913,025; 5,913,209; 5,915,253; 5,925,108; 5,933,503; 5,933,826; 5,946,002; 5,946,467; 5,950,198; 5,956,718; 5,956,745; 5,964,872; 5,974,474; 5,983,223; 5,983,234; 5,987,471; 5,991,771; 5,991,810; 6,002,398; 6,014,667; 6,015,132; 6,016,499; 6,029,247; 6,047,289; 6,052,724; 6,061,743; 6,065,017; 6,094,672; 6,098,090; 6,105,062; 6,105,132; 6,115,039; 6,119,122; 6,144,959; 6,151,688; 6,157,925; 6,167,393; 6,173,289; 6,192,365; 6,216,123; 6,219,652; 6,229,809. Patents Pending.

Novell, Inc.
1800 South Novell Place
Provo, UT 84606
U.S.A.

www.novell.com

NetWare 6 Overview and Installation Guide
[February 2002](#)

Online Documentation: To access the online documentation for this and other Novell products, and to get updates, see www.novell.com/documentation.

Novell Trademarks

ConsoleOne is a trademark of Novell, Inc.

GroupWise is a registered trademark of Novell, Inc., in the United States and other countries.

eDirectory is a trademark of Novell, Inc.

Internetwork Packet Exchange and IPX are trademarks of Novell, Inc.

NDS Manager is a trademark of Novell, Inc.

NE3200 is a trademark of Novell, Inc.

NetWare is a registered trademark of Novell, Inc., in the United States and other countries.

NetWare Loadable Module and NLM are trademarks of Novell, Inc.

NetWare Management Agent is a trademark of Novell, Inc.

NetWare Management Portal is a trademark of Novell, Inc.

NetWare Peripheral Architecture is a trademark of Novell, Inc.

Novell is a registered trademark of Novell, Inc., in the United States and other countries.

Novell Client is a trademark of Novell, Inc.

Novell Cluser Services is a trademark of Novell, Inc.

Novell Directory Services and NDS are registered trademarks of Novell, Inc., in the United States and other countries.

Novell Distributed Print Services is a trademark and NDPS is a registered trademark of Novell, Inc., in the United States and other countries.

Novell iFolder is a trademark of Novell, Inc.

Novell Support Connection is a registered trademark of Novell, Inc., in the United States and other countries.

Open Data-Link Interface and ODI are trademarks of Novell, Inc.

SFT and SFT III are trademarks of Novell, Inc.

Storage Management Services and SMS are trademarks of Novell, Inc.

Transaction Tracking System and TTS are trademarks of Novell, Inc.

Virtual Loadable Module and VLM are trademarks of Novell, Inc.

ZENworks is a trademark of Novell, Inc.

Third-Party Trademarks

All third-party trademarks are the property of their respective owners.

Preface	9
Documentation Conventions	9
User Comments	10
1 Welcome to NetWare 6	11
Make End Users More Effective with NetWare 6	11
Eliminate Client Software with Novell Native File Access Protocols	11
Print from Anywhere with Novell iPrint	12
Access and Manage Your Files from Anywhere with Novell iFolder	12
Use Novell NetStorage to Access Files with an Internet Browser	13
Store and Retrieve Network Data With Novell NetDrive	13
Access Internet Services from a Centralized Location with NetWare WebAccess.	14
Manage the Network with NetWare 6	14
Manage Your Network with NetWare Remote Manager	14
Manage eDirectory Objects from an Internet Browser with Novell iManager.	15
Manage the Network with ConsoleOne.	15
Manage IP Addresses with the Novell DNS/DHCP Administration Tool	16
Powering Net Services with Novell Web Services	16
Publish Web Pages with NetWare Enterprise Web Server.	18
Run Applications on NetWare Using the Tomcat Servlet Engine	18
Provide Custom Search Services with NetWare Web Search Server	18
Manage UNIX and NetWare Networks with Network Information Services	18
Track Network Usage with Novell Advanced Audit Service	19
Track Application Licenses with Novell Licensing Services	19
Build on an Established Networking Platform	19
Increase Availability with Novell Cluster Services	20
Manage Millions of Network Objects with Novell eDirectory	21
Manage Disk Storage Devices with Novell Storage Services	21
Mint Digital Certificates with Novell Certificate Server	21
Verify Identity with Novell Modular Authentication Service.	21
Back up Data with Storage Management Services.	22
Communicate with IP, the Protocol of the Internet	22
Support IPX Applications with Compatibility Mode Driver	22
Reduce Deployment Costs with NetWare 6	23
Streamline the Server Installation with the NetWare 6 Express Installation	23
Customize the Server Configuration with NetWare 6 Custom Installation	23
Migrate Network Data to another Server with NetWare Migration Wizard	24
Use Other Installation Options to Simplify the Move to NetWare 6.	24
Let's Get Started	25
Step 1: Decide What Solutions You Want	25
Step 2: Install or Upgrade to NetWare 6	25
2 Setting Up NetWare 6	27
Meeting System and Software Requirements	27

System Requirements	27
Software and Other Requirements	29
Preparing the Network.	30
Preparing the Computer	33
Installing Computer and Networking Hardware	33
Creating and Formatting a DOS Partition	34
Accessing the Installation Files	35
Installing the Software	35
Navigating in the Character-Based Screens.	35
Selecting the Type of Installation and Regional Settings	36
Selecting the Language and Accepting the License Agreement	36
Selecting the Type of Installation	37
Specifying Server Settings.	38
Selecting the Regional Settings	40
Selecting the Mouse and Video Type	41
Selecting a Platform Support Module and Storage Adapter.	41
Selecting a Platform Support Module (If Required)	42
Selecting a PCI Hot Plug Module (If Required)	42
Selecting a Storage Adapter	43
Selecting a Storage Device and a Network Board	43
Selecting a Storage Device	44
Selecting a Network Board	45
Loading a NetWare Loadable Module (If Required)	45
Creating a NetWare Partition and Volume SYS:	45
Removing an Existing Volume SYS: (Conditional).	46
Creating Volume SYS:	47
Summary.	48
Naming the Server	48
Enabling Cryptography	49
Installing the NetWare Server File System	50
Understanding Volumes	50
Creating Volumes	52
Modifying Volumes.	52
Deleting Volumes	53
Mounting Volumes	53
Installing Networking Protocols	54
About Internet Protocol (IP)	55
About IPX	56
Using Both IP and IPX	56
Setting Up Domain Name Service.	56
Configuring a NetWare Server as a DNS Server (Optional).	58
Setting the Server Time Zone	58
Setting Up Novell eDirectory	58
Choosing the Type of eDirectory Installation	59

Install the Server into an Existing eDirectory Tree	60
Creating a New eDirectory Tree	61
Summary	61
Licensing the NetWare Server	62
Install Networking Products	63
Configuring IP-Based Services (Conditional)	64
Installing Novell Certificate Server	69
Configuring LDAP	70
Installing Novell Native File Access Protocols	73
Setting Up NetWare WebAccess	82
Setting Up Novell iManager	85
Install Novell iFolder	86
Install Novell NetStorage	87
Customizing the Installation	89
Completing the Server Installation	91
What's Next?	92
3 Upgrading to NetWare 6	93
Meet System and Software Requirements	94
System and Software Requirements	94
Software and Other Requirements	94
Preparing the Network	95
Preparing the Computer	98
Backing Up the NetWare Server Files	99
Preparing Application Files Prior to Upgrading	99
Verify a Valid DOS Partition	100
Access the Installation Files	100
What's Next	101
4 Installing Products and Updates	103
Updating NSS Volumes	103
Installing Additional Products	103
Installing or Updating Novell Client Software	104
Installing Product Updates	105

Preface

This book is divided into the following sections:

- ♦ **Chapter 1, “Welcome to NetWare 6,” on page 11** explains the features and benefits of NetWare 6. It also includes descriptions of products that ship with NetWare 6 and how they add value to your network.
- ♦ **Chapter 2, “Setting Up NetWare 6,” on page 27** explains the prerequisites and instructions for installing a NetWare 6 server.
- ♦ **Chapter 3, “Upgrading to NetWare 6,” on page 93** explains the prerequisites and instructions for upgrading to NetWare 6 from a NetWare 3, 4, or 5 server.
- ♦ **Chapter 4, “Installing Products and Updates,” on page 103** explains the tasks that should be completed after installing or upgrading to NetWare 6.

NetWare 6 online documentation and any relevant corrections or updates are also available at the [Novell Product Documentation Web site \(http://www.novell.com/documentation\)](http://www.novell.com/documentation).

Novell Education offers a variety of courses that help you maximize your investment in NetWare 6. For course descriptions, details, and locations of training events, visit the [Novell Education Web site \(http://www.novell.com/education/netware6\)](http://www.novell.com/education/netware6).

Documentation Conventions

In this documentation, a greater-than symbol (>) is used to separate actions within a step and items in a cross-reference path.

Also, a trademark symbol (® , ™, etc.) denotes a Novell trademark. An asterisk (*) denotes a third-party trademark.

User Comments

We want to hear your comments and suggestions about this manual and the other documentation included with NetWare 6.

To contact us, send e-mail to webdoc@novell.com or send comments to:

Novell, Inc.

Product Documentation

MS PRV-H-411

1800 South Novell Place

Provo, UT 84606 USA

Fax (801) 861-3002

1

Welcome to NetWare 6

NetWare[®] 6 provides your business and your network with new solutions, updated products, and rock-solid applications that give you the power to change.

NetWare 6 is the Net services software solution that adds tremendous value to your company's ability to communicate on your network and on the Internet. With nonstop access, Net-ready security, and high availability, NetWare 6 delivers file storage, printing, directory, e-mail, and database resources that can be accessed as one Net across all type of networks—corporate and public, wired and wireless, storage systems and client desktops.

NOTE: This section contains several references to other pieces of NetWare 6 documentation. This documentation is available on the *NetWare 6 Online Documentation* CD and on the [NetWare 6 Product Documentation Web site \(http://www.novell.com/documentation/lg/nw6p\)](http://www.novell.com/documentation/lg/nw6p).

Make End Users More Effective with NetWare 6

NetWare 6 provides solutions that simplify the system administration responsibility while at the same time increasing the efficiency of the end user. Several new products help end users access, synchronize, and print their files from any location.

Eliminate Client Software with Novell Native File Access Protocols

Novell[®] Native File Access Protocols let Macintosh*, Windows*, and UNIX* workstations access and store files on NetWare servers without having to install any additional software—such as Novell Client™ software. The

software is installed only on the NetWare server and provides “out of the box” network access. Just plug in the network cable, start the computer, and you’ve got access to servers on your network. No more client configuration. No more client software. No more problems.

For more information, see the *Novell Native File Access Protocols Installation and Administration Guide*.

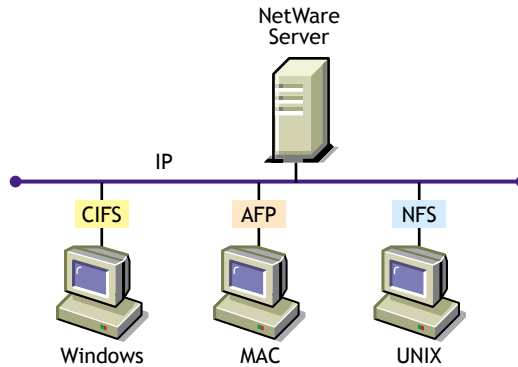

Print from Anywhere with Novell iPrint

Novell iPrint allows mobile employees, business partners, and customers to access printers from a variety of remote locations using existing Internet connections. Users install printers and manage print jobs using a Web browser. Administrators set up Web pages with a list of available printers or create maps with printer locations to aid users in finding the printer closest to them.

For more information, see the *iPrint Administration Guide*.

Access and Manage Your Files from Anywhere with Novell iFolder

Novell iFolder is a file storage and management solution to the universal problems associated with storing and retrieving data. With iFolder you have the latest version of your data when you need it and where you need it from any computer that you regularly use. And if you are not at a computer that you regularly use, you can still access and manage your files if you have an Internet connection and a Java*-enabled browser.

For more information, see the *Novell iFolder Administration Guide*.

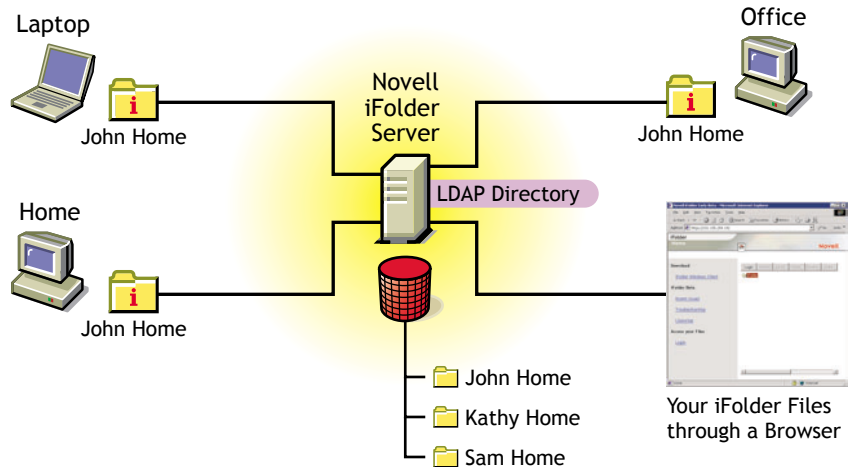

Use Novell NetStorage to Access Files with an Internet Browser

Novell NetStorage provides simple Internet-based access to file storage and serves as a bridge between a company's protected Novell network and the Internet. It allows users secure file access from any Internet location, with nothing to download or install on the user's workstation. Files and folders on a Novell network can be accessed using either a browser or Microsoft* Web Folders.

For more information, see the *Overview* quick start.

Store and Retrieve Network Data With Novell NetDrive

Novell NetDrive is a file storage solution to the universal problems associated with storing and retrieving data. With NetDrive, users can map a drive to a Web or FTP server with only an Internet connection, thereby eliminating the need to have a Novell Client. When connected to the Web or FTP server, they can perform all the familiar file operations that they now use in Windows Explorer.

For more information, see the *Novell NetDrive Administration Guide*.

Access Internet Services from a Centralized Location with NetWare WebAccess

NetWare WebAccess allows administrators to set up a Web page that lets users access multiple network resources from their Web browser. Users do not need a Novell Client or VPN client to access to their resources. They can access these resources on the Web from any computer with a compliant browser.

Customized content is provided through *gadgets*. A gadget provides access to specific content on the network. Gadgets communicate with the appropriate back-end system to gather the necessary data for a particular user—and users can access it all with a single password.

For more information, see *NetWare WebAccess Overview and Installation*.

Manage the Network with NetWare 6

NetWare 6 includes many new utilities to help you easily and effectively manage your network. As a network administrator, you will find that these utilities provide you with a host of solutions to simplify, secure, and manage your network.

Manage Your Network with NetWare Remote Manager

NetWare Remote Manager lets you use a Web browser to securely access NetWare servers from any workstation and perform specific server management tasks. From Remote Manager, you can monitor the health of your servers, their processes, and CPU usage.

You can also perform common server management tasks more quickly such as mounting and dismounting volumes, managing server connections, configuring SET parameters, viewing the configuration of the server, accessing files on volumes and DOS partitions, and even shutting down, restarting, and resetting your server. Through the Console Screens applet, you can view and run all the console screens just as though you were using the keyboard at the server console.

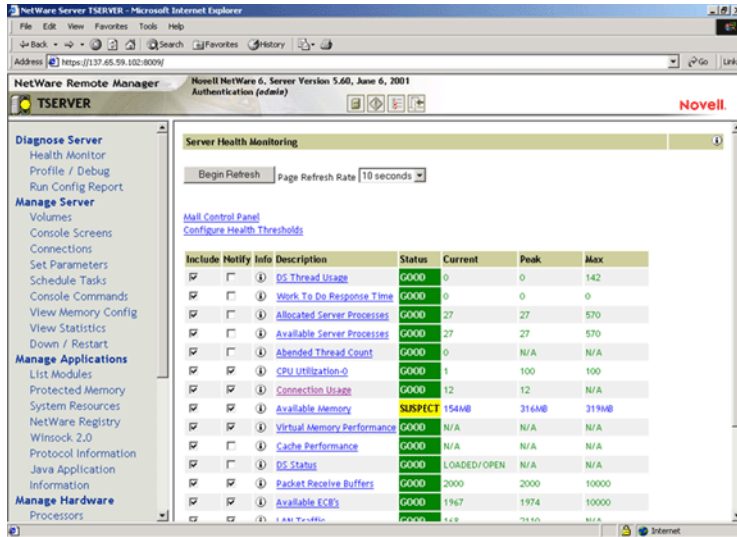

For more information about NetWare Remote Manager, see the *NetWare Remote Manager Administration Guide*.

Manage eDirectory Objects from an Internet Browser with Novell iManager

Novell iManager runs in an Internet browser and is used for administering, managing, and configuring Novell eDirectory objects. Novell iManager lets you assign specific tasks or responsibilities to users and presents users with only the tools (and accompanying rights) necessary to perform those tasks. In NetWare 6, you can use Novell iManager to administer iPrint, DNS/DHCP, and Novell Licensing Services.

For more information, see the *Novell iManager Administration Guide*.

Manage the Network with ConsoleOne

ConsoleOne™ is a Java-based administration tool that you can use to flexibly manage Novell and third-party products on a variety of platforms. Running on either a NetWare server or a Windows workstation, ConsoleOne provides a single point of administration for your network resources, including eDirectory objects, schema, partitions, replicas, and NetWare servers.

With ConsoleOne, you can modify properties of multiple files, folders, objects, and volumes simultaneously. You can also use ConsoleOne to quickly browse large eDirectory trees, manage user accounts, administer rights, and extend eDirectory schema.

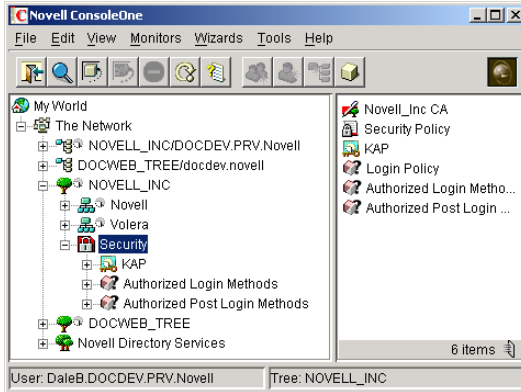

Novell ConsoleOne

For more information, see the *ConsoleOne 1.3 User Guide*.

Manage IP Addresses with the Novell DNS/DHCP Administration Tool

The DNS/DHCP Administration Tool runs in an Internet browser and enables network administrators to easily configure and manage DNS (Domain Name System Service) and DHCP (Dynamic Host Configuration Protocol Service).

For more information, see the *Novell DNS/DHCP Services Administration Guide*.

Powering Net Services with Novell Web Services

Novell Web Services is a collection of products such as Tomcat Servlet Engine, NetWare Enterprise Web Server, Apache Web Server, and WebDAV, technologies that enable Novell's Net Services products to work.

The following diagram depicts the role that Novell Web Services plays as the Web-enabling technology for Net Services Software such as iFolder, iPrint, iLogin, and Web Search Server.

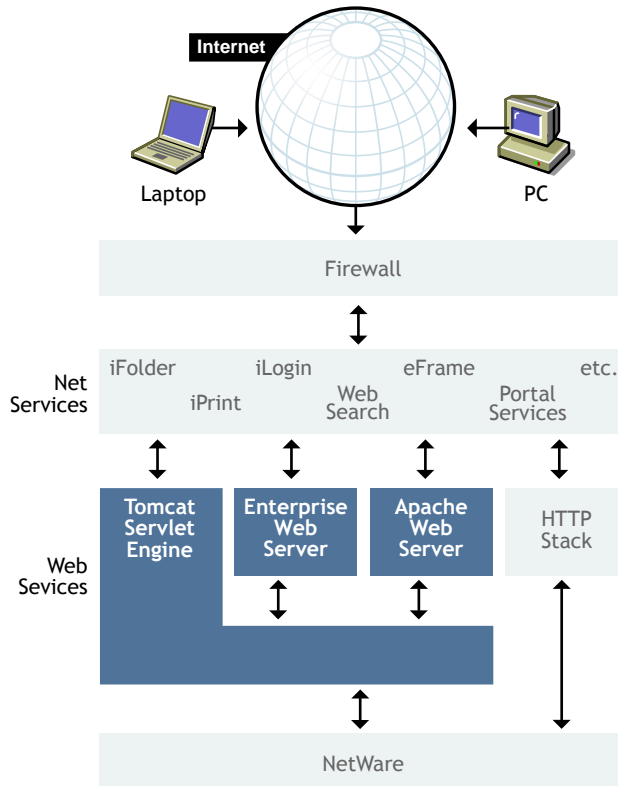

NetWare 6 lets you manage documents with WebDAV, transfer files using FTP, and communicate with HTTP.

For more information, see *Getting Results with Novell Web Services*.

Manage Novell Web Services with NetWare Web Manager

NetWare Web Manager is the tool you use to manage all of your Novell Web Services and to access other Web-based management tools. You can manage your Novell Web Services from any place on the Internet using an Internet browser.

For more information, see "[Introducing NetWare Web Manager](#)" in *Getting Results with Novell Web Services*.

Publish Web Pages with NetWare Enterprise Web Server

The NetWare Enterprise Web Server is optimized to run in the NetWare environment. It serves up Web pages to the Internet, an intranet, or an extranet.

Use the NetWare Enterprise Web Server to communicate across departments or throughout the world. Let customers, suppliers, vendors, or consultants access specific information. Of course, you can publish information on the Internet so that the whole world can see it and even contribute to it.

For more information, see "[Putting the Web Server to Work](#)" in *Getting Results with Novell Web Services*.

Run Applications on NetWare Using the Tomcat Servlet Engine

If you have or develop java applications that run on a server, NetWare 6 can run them using the Tomcat Servlet Engine.

For more information, see "[Extending Your Server with Programs](#)" in *Getting Results with Novell Web Services*.

Provide Custom Search Services with NetWare Web Search Server

NetWare Web Search allows users to find the information they're looking for on any of your public and private Web sites, your partners' sites, and any number of additional Web sites across the Internet all from a single search form on your Web page.

For more information, see "[Introducing NetWare Web Search Server](#)" in *Getting Results with Novell Web Services*.

Manage UNIX and NetWare Networks with Network Information Services

Network Information Service (NIS) lets you use Novell eDirectory™ to manage UNIX computers by providing information about users, groups, and hosts and other information that NIS client might require. It maintains all information in the form of eDirectory objects organized under the eDirectory tree. NIS supports standard NIS maps and user-defined (custom) NIS maps.

For more information, see the *Novell Native File Access Protocols Installation and Administration Guide*.

Track Network Usage with Novell Advanced Audit Service

Novell Advanced Audit Service (NAAS) is an Novell eDirectory enabled robust, flexible, and scalable auditing framework. It can audit services, both Novell and third-party, and can provide a single, unified view of audit data for the entire Net. It provides a single point of management by storing configurable audit policies in eDirectory.

It adds auditing capability to the Net and thus addresses the security-related concerns of enterprises when their networks are thrown open to their customers, suppliers, and partners.

For more information, see the *Novell Advanced Audit Service Installation and Administration Guide*.

Track Application Licenses with Novell Licensing Services

Novell Licensing Services (NLS) is a distributed, enterprise network service that enables administrators to monitor and control the use of licensed applications on a network. NLS also provides a basic license metering tool, as well as libraries that export licensing service functionality to developers of other licensing systems. NLS is tightly integrated with the Novell eDirectory technology and is based on an enterprise service architecture.

For more information, see the *Novell Licensing Services Administration Guide*.

Build on an Established Networking Platform

NetWare 6 combines new technologies with a tried-and-true network operating system, giving you a platform that meets the needs of your growing business and network.

Increase Availability with Novell Cluster Services

NetWare 6 includes Novell Cluster Services™, which ensures high availability and manageability of critical network resources including data (volumes), applications, server licenses, and services. It is a multinode clustering product for NetWare that is enabled for Novell eDirectory and supports failover, failback, and migration (load balancing) of individually managed cluster resources.

Novell Cluster Services allows you to configure up to 32 NetWare servers into a high-availability cluster, where resources can be dynamically switched or moved to any server in the cluster. Resources can be configured to automatically switch or be moved in the event of a server failure, or they can be moved manually to troubleshoot hardware or balance the workload.

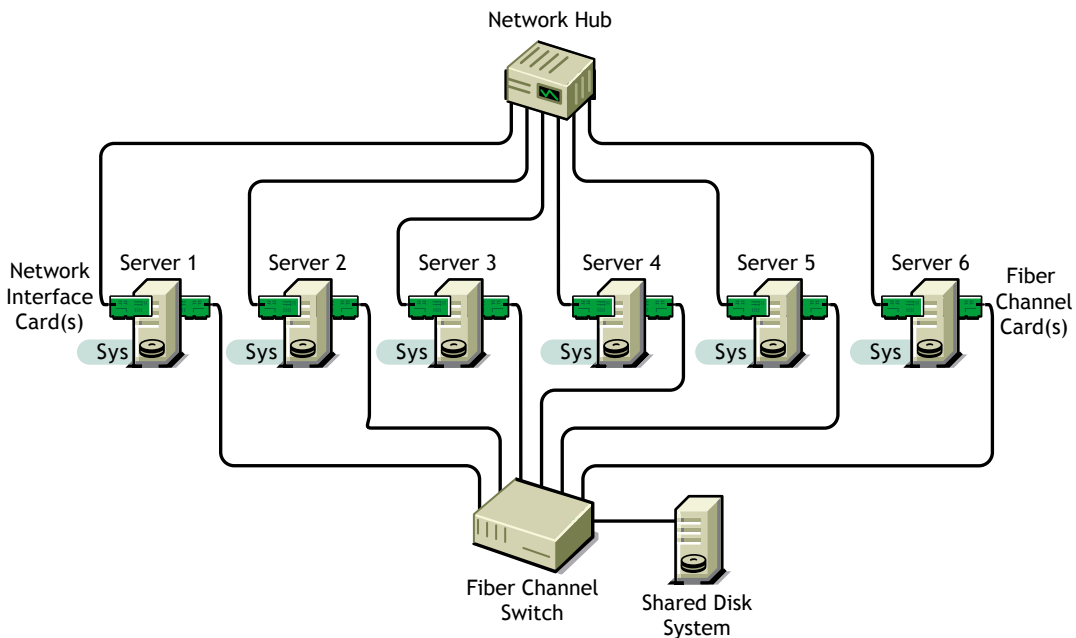

For more information, see *Novell Cluster Services Overview and Installation*.

Manage Millions of Network Objects with Novell eDirectory

Novell eDirectory is a full-service, platform-independent LDAP directory that can store and manage millions of objects, such as users, applications, network devices, and data.

Novell eDirectory provides replication and partitioning capabilities and serves as the foundation for directory-enabled services such as automated business-relationship management, supply-chain management, electronic store fronts, automated provisioning, enhanced security, customer profiling, electronic wallets, automated notification systems, customized Web interfaces, and virtual private networks (VPNs).

For more information, see the *Novell eDirectory 8.6 Administration Guide*.

Manage Disk Storage Devices with Novell Storage Services

Novell Storage Services (NSS) is a file storage and management system that meets the needs of your growing file system requirements. NSS can take free space from multiple storage devices and create unlimited volumes which can store up to 8 trillion files (each up to 8 terabytes in size). You can quickly mount as many as 255 volumes. NSS lets you mount, configure, and maintain volumes without disrupting the work of end users.

For more information, see the *Novell Storage Services Administration Guide*.

Mint Digital Certificates with Novell Certificate Server

Novell Certificate Server allows you to mint, issue, and manage digital certificates. When Novell Certificate Server is installed, it creates a Security container object, an Organizational Certificate Authority (CA) object, and two server certificates. The server certificates enable secure data transmissions and is required for Web-related products such as NetWare Web Manager and NetWare Enterprise Web Server.

For more information, see *Novell Certificate Server*.

Verify Identity with Novell Modular Authentication Service

Novell Modular Authentication Service (NMAS) is designed to help you protect information on your network. NMAS brings together additional ways of authenticating to Novell eDirectory and to Windows NT/2000 networks to

help ensure that the people accessing your network resources are who they say they are.

For more information, see the *Novell Modular Authentication Service Administration Guide*.

Back up Data with Storage Management Services

Storage Management Services™ (SMS™) is the data protection system for all your storage requirements. SMS allows backup and restore of targets such as eDirectory, the file system, or an individual workstation's hard disk onto a tape device that can be stored offsite.

If you have a hardware failure, corrupted data, or incorrectly deleted or changed data, you can recover a previous version of the data. New features of SMS to look for are superior performance and support for cluster resources.

For more information, see the *Storage Management Services Administration Guide*.

Communicate with IP, the Protocol of the Internet

Novell TCP/IP software allows connectivity between different hosts in an Internet environment. The TCP/IP stack lets you group multiple boards using a multihoming feature. It also allows you to balance the load across different configured boards and to ensure minimum downtime in case of board failure. It provides high security, performance, and reliability of the host in the Internet environment.

Novell TCP/IP offers an extensive set of configurable parameters for all supported protocols. You can use these parameters to modify the default characteristics of the initial configuration and also to configure advanced features and optimize host, router, and LAN performance options.

For more information, see the *NetWare TCP/IP Administration Guide*.

Support IPX Applications with Compatibility Mode Driver

The Compatibility Mode Driver (CMD) helps you access NetWare services using the IP protocol. The CMD services are used only when the system uses an IPX™ application or tries to establish connections between IP and IPX

systems. These drivers are automatically loaded on both the NetWare clients and servers when installed as IP-only systems. The IPX Compatibility Driver also allows IP systems to communicate with IPX systems by using Migration Agents.

The Migration Agent is a migration component that enables communication between IPX and IP systems and creates an IP backbone that connects IPX segments. The Migration Agent is used to migrate systems from IPX to IP in a phased manner without losing connectivity.

For more information, see the *Server Communications Administration Guide*.

Reduce Deployment Costs with NetWare 6

NetWare 6 includes several options that help you install a new server, upgrade a legacy NetWare server, or migrate from a Windows NT* server. Whether you need to install one or a thousand servers, NetWare 6 has an installation option that will help you get the job done.

Streamline the Server Installation with the NetWare 6 Express Installation

NetWare 6 includes an installation option that lets you accept the recommended default values and quickly install a server. Drivers for disks and network boards are automatically discovered and loaded, volume SYS: is automatically created, and default products are installed. Using the Express Installation option, you'll breeze through the task of installing a server.

Customize the Server Configuration with NetWare 6 Custom Installation

If your networking environment requires a specific configuration, NetWare 6 lets you select which components and products will be installed and what location they will be installed to. You can also make volumes and partitions as large as you want. The NetWare 6 Custom Installation option gives you the flexibility you require.

Migrate Network Data to another Server with NetWare Migration Wizard

NetWare Migration Wizard is a solution to the difficulties associated with upgrading your hardware and software. The Migration Wizard migrates data from Windows NT and NetWare 3, 4, 5, or 6 to a computer running NetWare 5 or 6.

For more information, see the *NetWare Migration Wizard 6 Administration Guide*.

Use Other Installation Options to Simplify the Move to NetWare 6

Several other options are also available to help you install or upgrade to NetWare 6.

Quickly upgrade with NetWare Accelerated Upgrade—You can run NetWare Accelerated Upgrade from a Windows client workstation so that you don't need to be physically present at the server console. Although NetWare Accelerated Upgrade is quicker than the standard installation process, it does not install additional network products, licensing services, or license certificates.

Automate the NetWare installation with a response file—Installing the NetWare operating system software can be easier and more flexible when you use a response file. When used with the graphical server installation, a response file lets you set and display specific default values, bypass entire sections of the installation, and automate the entire server installation process.

Use installation scripts to control the installation—NetWare installation scripts let you alter or extend the NetWare installation process. You can use installation scripts to install additional products on a server after the operating system has been installed.

For more information on these options, see *Other Installation Options*.

Let's Get Started

Now that you're familiar with the power of NetWare 6, you can see that it provides you with a lot of options. The next step is to decide what products and solutions you want—and then install your NetWare 6 servers.

Step 1: Decide What Solutions You Want

Before installing your NetWare 6 servers, make sure that you read all about your chosen solutions. Some products require that you install the server in a specific way.

Step 2: Install or Upgrade to NetWare 6

You have several options for installing and upgrading to NetWare 6. Choose the option that best meets your needs and follow the instructions provided.

Installation Option	Refer to
Add a NetWare 6 server to an existing network	Chapter 2, "Setting Up NetWare 6," on page 27
Upgrade from NetWare 3, NetWare 4, or NetWare 5	Chapter 3, "Upgrading to NetWare 6," on page 93
Migrate data from another NetWare server or NT Server	<i>NetWare Migration Wizard 6 Administration Guide</i>
Use advanced installation/upgrade options	<i>Other Installation Options</i>

All this information is available on the *NetWare 6 Online Documentation CD* included with the NetWare 6 product and on the [NetWare 6 Product Documentation Web site \(http://www.novell.com/documentation/lg/nw6p\)](http://www.novell.com/documentation/lg/nw6p).

2

Setting Up NetWare 6

This chapter describes how to set up a NetWare[®] 6 server. The process includes the following tasks:

- ◆ Meet system and software requirements
- ◆ Prepare the network and the computer
- ◆ Determine the type of installation
- ◆ Specify hardware and software settings
- ◆ Create volume SYS:
- ◆ Name the server and install the server file system
- ◆ Install networking protocols
- ◆ Set up Novell eDirectory
- ◆ Install other networking products

Meeting System and Software Requirements

System Requirements

NetWare will run on the minimum system requirements listed below. For optimal performance, the computer should meet the recommended requirements.

Minimum System Requirements

NetWare 6 has the following minimum system requirements:

- A server-class PC with a Pentium* II or AMD* K7 processor
- 256 MB of RAM
- A Super VGA display adapter
- A DOS partition of at least 200 MB and 200 MB available space
- 2 GB of available disk space outside the DOS partition for volume SYS:
- One network board
- A CD drive
- A USB, PS/2*, or serial mouse (recommended but not required)

Recommended System Requirements

For optimal performance, NetWare 6 has the following recommended system requirements:

- A multiprocessor PC with at least two Pentium III 700 MHz or higher processors

NOTE: NetWare 6 can run on as many as 32 processors.

- 512 MB of RAM
- A Super VGA or higher resolution display adapter
- A DOS partition with 1 GB of available space

NOTE: To determine the optimal size of a boot partition, add the amount of server memory to the minimum amount of the available disk space. The minimum amount of available space is 200 MB, so a server with 1024 MB RAM has an optimal boot partition of 1224 MB (1024 MB + 200 MB = 1224 MB). This size will allow you to do a core dump to the disk drive if required.

- 4 GB of available disk space outside the DOS partition
- One or more network boards
- A bootable CD drive that supports the El Torito specification
- A USB, PS/2, or serial mouse

Software and Other Requirements

Depending on the network configuration, you might need one or all of the following software and information:

- NetWare 6 Operating System CD*
- NetWare 6 License/Cryptography* diskette
- Supervisor right at the [Root] of the eDirectory™ tree
- Supervisor right to the container where the server will be installed
- Read right to the Security container object for the eDirectory tree
- DOS and CD drivers (required if the computer does not boot from CD)

You can make a bootable floppy diskette using the MKFLOPPY.BAT program located in the INSTALL directory of the *NetWare 6 Operating System CD*.

- Client connection utilities (optional, for installing from a network):
 - ◆ Novell Client™ for DOS and Windows* 3.1x (optional, for installing from a NetWare server running IPX™).
 - ◆ IP Server Connection Utility (optional, for installing from a NetWare server running IP only).

For instructions, see PRODUCTS\SERVERINST\IPCONN.TXT on the *Novell Client CD*.

- IP address and domain names (required for connecting to the Internet):
 - ◆ An IP address
 - ◆ An IP address of a domain name server
 - ◆ The name of your domain

For IP addresses and domain names, contact your network administrator and Internet Service Provider.

- Network board and storage device properties, such as the interrupt and port address (required if not included in NetWare)

For more information, contact your computer hardware manufacturer.

Next, you should prepare the network for the NetWare 6 server. If this server is not being integrated into an existing network, you can skip to “[Preparing the Computer](#)” on page 33.

Preparing the Network

Before you introduce a NetWare 6 server into an existing network, you must run NetWare Deployment Manager to update the network.

To update the network for NetWare 6, you must do the following:

- 1 Log in from a Windows 95/98 or Windows NT/2000 workstation to your existing network as a user with the Supervisor right.

If prompted to log into the network while using NetWare Deployment Manager, you can enter the server name or click Details and specify the IP address.

- 2 Run NetWare Deployment Manager (NWDEPLOY.EXE), located on the *NetWare 6 Operating System CD*.

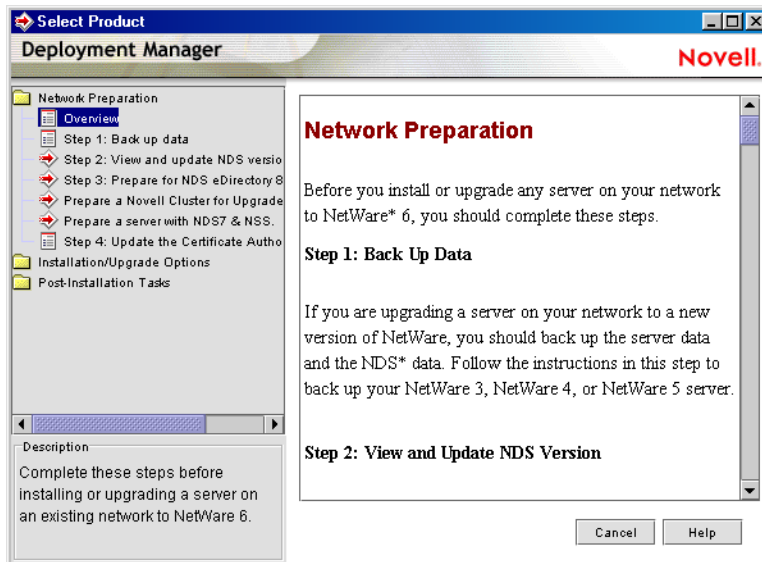

- 3 Double-click the Network Preparation folder to view the tasks and read the Overview section to get an understanding of the tasks.

- 4 Back up any server data and Novell® eDirectory data following the instructions in the Back Up Data step.
- 5 Run the View and Update eDirectory Version program to update eDirectory as required.

HINT: If you are prompted to log in again while running NetWare Deployment Manager, you can enter the IP address of the server by clicking Details.

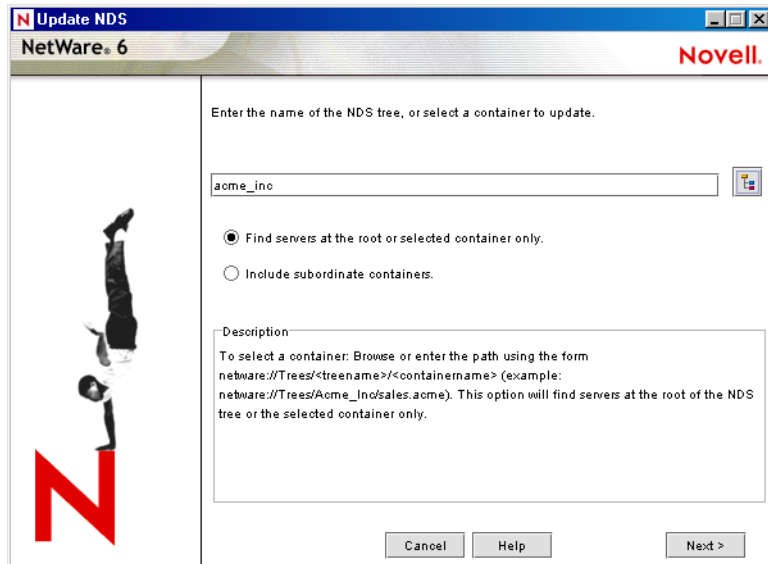

- 6 Run the Prepare for eDirectory program to extend the network schema.

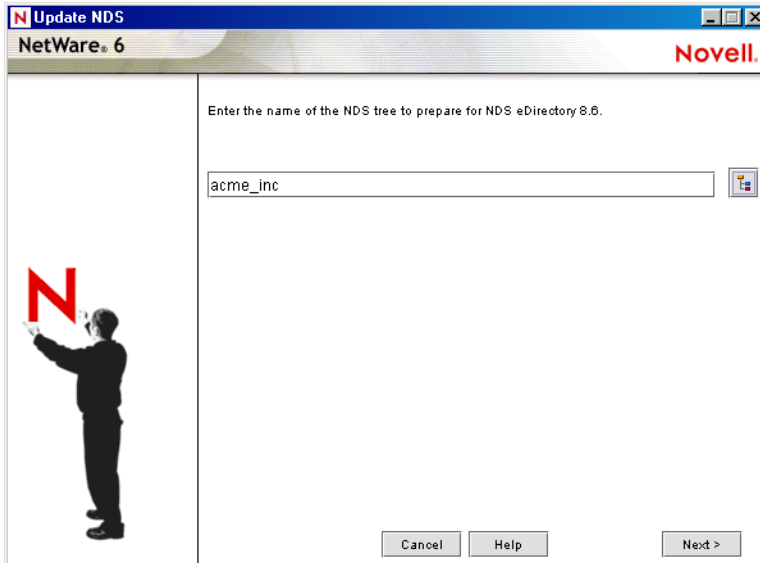

- 7** (Conditional) If you are upgrading a cluster of NetWare servers, run the Prepare a Novell Cluster for Upgrade program.
- 8** (Conditional) If you are upgrading a NetWare 5 server running NDS[®] 7 that has NSS volumes, run the Prepare a Server with NDS 7 and NSS program.
- 9** Follow the instructions in the Update Certificate Authority (CA) Object step to create or update a Security container object and a Certificate Authority (CA) object.

After you have completed the Network Preparation section of NetWare Deployment Manager, read through the Installation / Upgrade Options section to help you decide the option that best meets your needs.

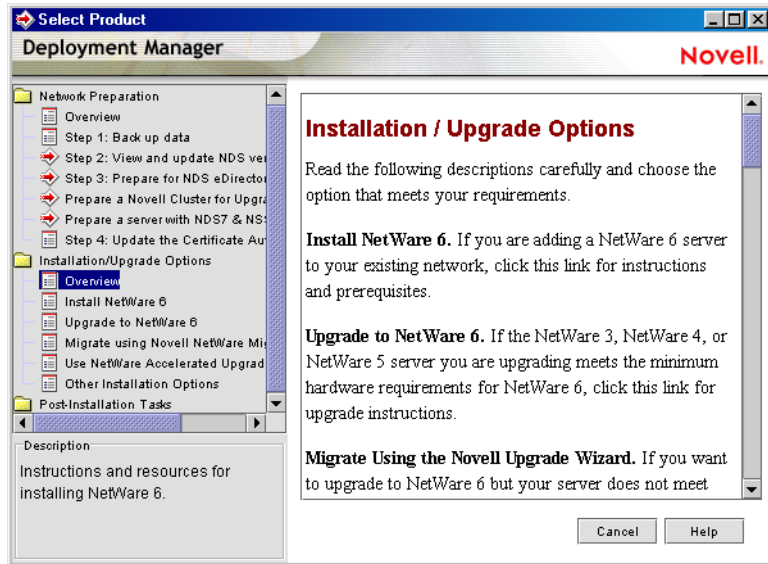

After choosing an installation or upgrade option, you should now prepare the computer to be a NetWare 6 server.

Preparing the Computer

To prepare your computer for NetWare 6, do the following:

- ◆ Install computer and networking hardware
- ◆ Create and format a DOS partition
- ◆ Access the installation files

Installing Computer and Networking Hardware

Follow the manufacturer's instructions to install and connect the network board and network cabling to your computer. Make sure that all storage devices are properly attached to storage adapters.

Creating and Formatting a DOS Partition

NetWare requires a DOS partition to start the computer and load NetWare. The DOS partition contains the NetWare startup and server files.

HINT: You should increase the size of your DOS partition to accommodate your specific configuration requirements. See “[System Requirements](#)” on page 27.

To create and format a DOS partition, complete the following steps.

- 1** Back up any desired data to another computer or offline storage media.
- 2** Insert the *NetWare 6 Operating System* CD and boot the computer.
- 3** Complete one of the following:
 - ◆ If the computer boots from the CD, follow the on-screen prompts to create and format a partition. Skip to “[Selecting the Language and Accepting the License Agreement](#)” on page 36.
 - ◆ If you will be installing from files located on another server, continue with the following steps.
 - ◆ If the computer does not boot from the CD, continue with the following steps.

- 4** Boot your computer with DOS 3.3 or later.

You can make a bootable floppy diskette using the MKFLOPPY.BAT program located in the INSTALL directory of the *NetWare 6 Operating System* CD. You can boot from the *NetWare 6 License/Cryptography* diskette. DOS 7 and all required DOS utilities are included on the diskette and on the CD.

- 5** If the computer already has an operating system installed, such as Windows or NetWare, you should completely remove the partitions and the operating system.

Use FDISK to remove partitions.

- 6** Use FDISK to create an active DOS partition by entering **FDISK**.

Create a primary DOS partition and make it the active partition. See “[System Requirements](#)” on page 23 for minimum requirements.

The computer will restart.

- 7** Format and transfer DOS system files to the partition by changing to drive A: and entering **FORMAT C: /S**.

Your computer should now have an active DOS partition that meets or exceeds the minimum requirements. Continue the installation by accessing the installation files.

Accessing the Installation Files

NetWare 6 can be installed from the server's local CD drive or from installation files located on the network. To access the NetWare 6 installation files, complete the following steps.

- 1** Install the DOS CD driver for your CD drive onto the DOS partition.
DOS CD drivers are provided by the CD drive manufacturer.
Make sure that the logical filename of your CD drive (specified in the CONFIG.SYS and AUTOEXEC.BAT files) is *not* CDROM or CDINST.
- 2** Make sure that the CONFIG.SYS file contains the **FILES=100** and **BUFFERS=30** commands.
- 3** (Conditional) If you are installing from files located on a network, install the Novell Client for DOS and Windows 3.1x or IP Server Connection Utility software located on the *Novell Client* CD.

After accessing the files for the installation program, you can begin the installation.

Installing the Software

To begin the installation, complete the following steps.

- 1** Insert the *NetWare 6 Operating System* CD, or log in to the network to access the installation files on the network.
- 2** At the CD drive or network drive prompt, enter **INSTALL**.

Navigating in the Character-Based Screens

The initial screens of the installation program display in text-based mode. Auto-detected and default settings appear on each screen.

You can accept the detected and default settings, or you can modify the settings to meet the needs of your networking environment.

HINT: To continue the installation with the standard settings, use the arrow keys to select Continue in the Options box and then press Enter.

To modify the settings, use the arrow keys to select Modify in the Options box and then press Enter. Select the field to be modified and press Enter. Select or enter the appropriate value.

Some screens require additional keystrokes in order to navigate through the interface. Information about screen navigation appears at the bottom of each screen.

Selecting the Type of Installation and Regional Settings

To select the type of installation and select regional settings, you must

- ◆ Select the language and accept the License Agreement
- ◆ Select the type of installation
- ◆ Specify server settings
- ◆ Select the regional settings
- ◆ Select the mouse and video type

Selecting the Language and Accepting the License Agreement

The installation program is available in several languages. You can install other language options, such as the language for the operating system or for users, later during the installation program.

Accepting each License Agreement means that you have read and you accept terms and conditions contained in the License Agreement. Press F10 to accept.

Selecting the Type of Installation

Express Installation or Custom Installation

Express Installation

The Express Installation automatically detects drivers and installs the NetWare server with default settings and default software programs. The settings include the following

- ◆ 4 GB volume SYS: (Any remaining disk space will be left as free space.)
- ◆ LAN and disk drivers: Auto-discovered and loaded
- ◆ Default products installed
- ◆ Country Code: 1
- ◆ Codepage: 437
- ◆ Video mode: VGA Plug N Play
- ◆ Keyboard: United States
- ◆ Mouse: Auto-discovered and loaded

Custom Installation

The Custom Installation allows you to choose specific configuration options for your networking environment.

New Server, Upgrade or Pre-Migration Server

You can install NetWare on a new computer or you can upgrade an existing computer running NetWare 4 or NetWare 5.

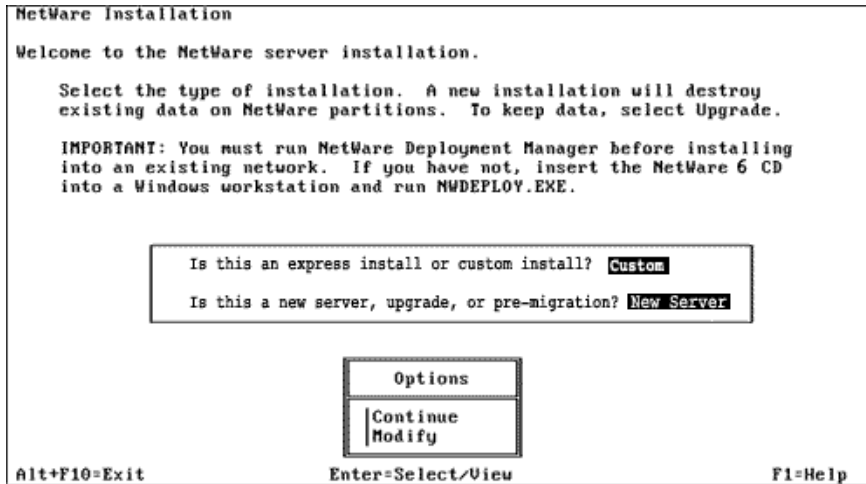

- ♦ **New Server**—Installs a new server. Creates a new NetWare partition but does not delete system partitions or other partitions such as DOS, UNIX*, or Windows.

If you select Express Installation, you can skip to [“Naming the Server” on page 48](#).

- ♦ **Upgrade**—If you are upgrading an existing server from a previous version of NetWare, select Upgrade. Upgrading retains all your server data such as files, directory structures, partitions, and volumes.

If you select Upgrade, you will skip entire sections of this chapter, depending on the configuration of the server.

- ♦ **Pre-Migration**—A Pre-Migration server is used to migrate data from one server to another using the NetWare Migration Wizard. For more information, see the *NetWare Migration Wizard 6 Administration Guide*.

To select the type of installation, in the Options box, select Modify and press Enter. Select the installation type and then return to the Options box to continue.

Specifying Server Settings

You can change the following default server settings for your networking environment.

- ◆ **Server ID Number**—A unique server identification number (up to eight hexadecimal digits) identifies the server on the network. The server ID number functions like an internal IPX number. Although a server ID number is created automatically, you might need to enter a specific server ID number if you are installing in either of the following conditions:
 - ◆ **Filtered environment**—Routers between network segments can be configured to forward data only from specific computer addresses. Data being sent from other computer addresses is not forwarded to other segments.

NOTE: If you are accessing the installation files from a server on a different network segment, you might not be able to reconnect to the server to complete the installation unless you specify an unfiltered server ID number.
 - ◆ **Numbering scheme**—Some network administrators set up a predetermined numbering scheme to identify servers in particular locations or organizations. For example, all servers in building A might begin with 0101, and all servers in building B might begin with 0102.

If you choose to install IP and not IPX, the SERVERID reference is not used and is removed from the AUTOEXEC.NCF file. You can add IPX after the server installation by adding the **SERVERID** *8_digit_number* command after the **SERVERNAME** command in the AUTOEXEC.NCF file.

- ◆ **Load Server at Reboot**—Select No if you do not want the AUTOEXEC.BAT and CONFIG.SYS files to contain the commands to automatically load the server operating system when the computer reboots. If you select Yes (default), the old AUTOEXEC.BAT and CONFIG.SYS files are renamed and saved with a .00x extension.
- ◆ **Server SET Parameters**—You might need to modify the SET parameters for some device drivers, such as for network boards and storage devices, in order to complete installation. SET parameters are saved to the STARTUP.NCF file.
- ◆ **Startup Directory**—The directory on the DOS partition that contains the files to launch the NetWare server. (This field will display only during an upgrade.)

Selecting the Regional Settings

NetWare Installation

Select the regional settings for the server.

Country:	001 (USA)
Code page:	437 (United States English)
Keyboard:	United States

Options
Continue
Modify

Alt+F10=Exit Esc=Back F1=Help

Choose the country, code page, and keyboard mapping for your language and computer.

Selecting the Mouse and Video Type

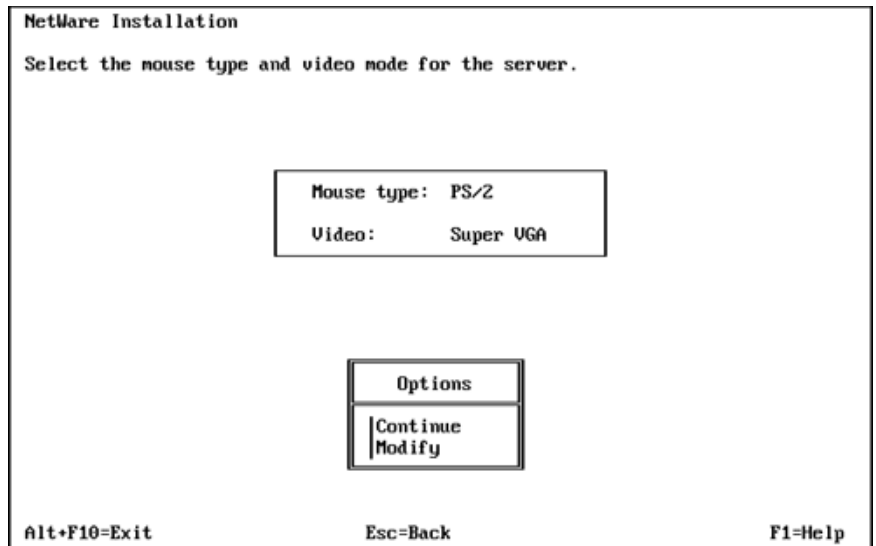

- ◆ **Mouse Type**—Choose a mouse type, if available on the computer. The installation program supports USB, PS/2 and serial mouse types, but a mouse is not required.
- ◆ **Video Type**—The NetWare installation program is optimized to display with video display hardware that is VESA 2 compliant.

NOTE: The video type is not auto-detected by the installation program. You must select the settings for the computer.

Selecting a Platform Support Module and Storage Adapter

To select a platform support module and storage adapter, you must

- ◆ Select a platform support module (if required)
- ◆ Select a PCI Hot Plug module (if required)
- ◆ Select and configure a storage adapter

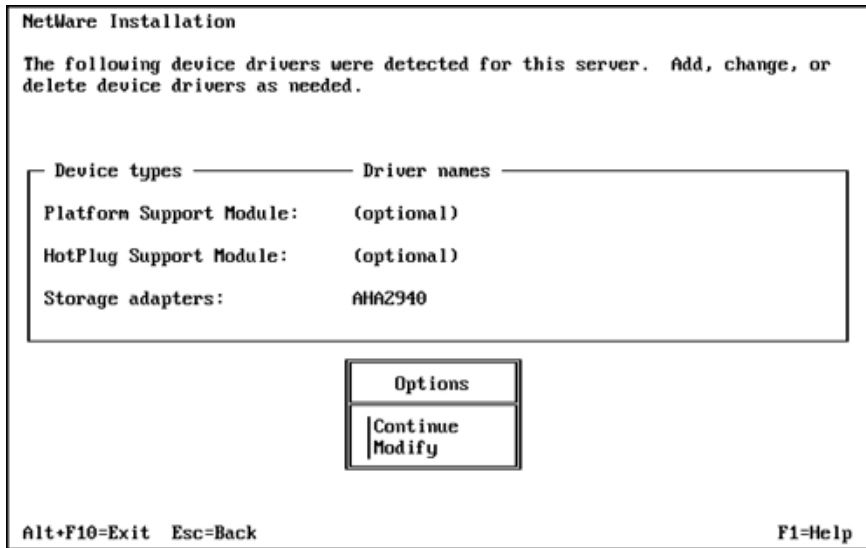

To *add* a driver, in the Options box select Modify. Select the driver field and press Enter. Press Insert to select from a list of drivers provided with NetWare. Press Insert again to install a driver from diskette.

To *delete* a driver, in the Options box select Modify. Select the driver field and press Enter. Select the driver to delete and press Delete.

To *modify* a driver, in the Options box select Modify. Select the driver field and press Enter. Select the driver to modify and press Enter. Select the property to modify.

Selecting a Platform Support Module (If Required)

A platform support module (PSM) provides increased performance for multiprocessor computers and some specific hardware configurations. If a PSM driver is required, it will be auto-detected. If the installation program does not detect a PSM driver, your computer does not need one.

NOTE: If a PSM driver is detected on a computer without multiple processors, you can allow the driver to load without adversely affecting performance.

Selecting a PCI Hot Plug Module (If Required)

Computers that support PCI Hot Plug technology allow storage adapters and network boards to be inserted and removed while the computer is on. If the

installation program does not detect a PCI Hot Plug support module, your computer probably does not support the PCI Hot Plug technology.

Selecting a Storage Adapter

A storage adapter provides a link between the computer and one or more storage devices. The storage adapter requires a software driver called a host adapter module (HAM) in order to communicate with the computer (host). Storage devices require a separate driver called a custom device module (CDM).

NOTE: .DSK drivers are no longer supported. Instead, NetWare uses the enhanced capability of NetWare Peripheral Architecture™ (NWPA). NWPA requires a HAM and a CDM.

Because a single adapter can control more than one type of storage device, your computer might require only a single HAM, even though it can have more than one type of storage device—and therefore multiple CDMs.

The installation program auto-detects many types of storage adapters, such as IDE and SCSI adapters. If your storage adapter is not detected, select the appropriate driver from the list of available drivers provided with NetWare or add a new driver from a diskette. HAMs can be obtained from the storage adapter manufacturer.

Editing the Properties of the Storage Adapter (If Required)

The storage adapter must be installed and configured correctly. Properties such as interrupt, port value, and slot must not conflict with any other device in the computer. If you need specific storage adapter properties, contact the storage adapter manufacturer.

Selecting a Storage Device and a Network Board

To select a storage device and network board, you must

- ◆ Select and configure the storage device
- ◆ Select and configure the network board
- ◆ Load a NetWare Loadable Module program (if required)

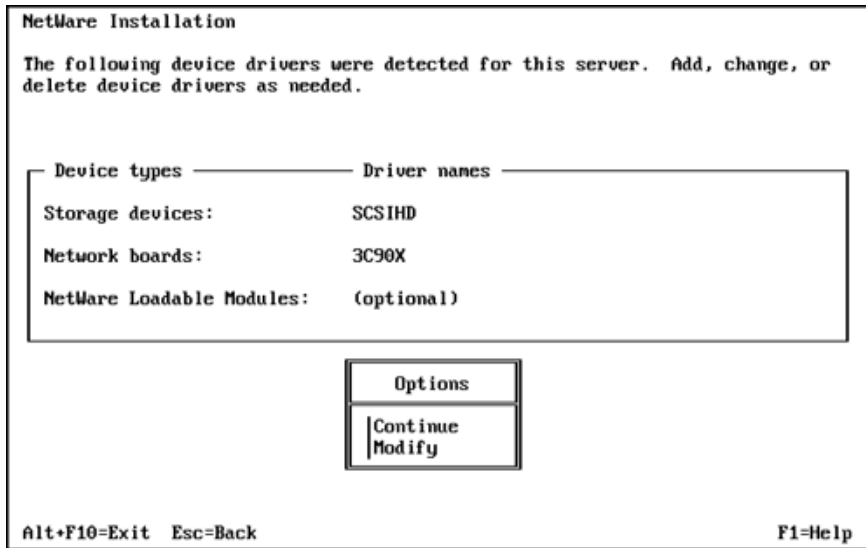

To *add* a driver, in the Options box select Modify. Select the driver field and press Enter. Press Insert to select from a list of drivers provided with NetWare. Press Insert again to install a driver from diskette.

To *delete* a driver, in the Options box select Modify. Select the driver field and press Enter. Select the driver to delete and press Delete.

To *modify* a driver, in the Options box select Modify. Select the driver field and press Enter. Select the driver to modify and press Enter. Select the property to modify.

Selecting a Storage Device

Storage devices such as hard disks, CD drives, and tape devices require a software driver to communicate with the storage adapter. The software driver for the storage device is called a *custom device module* (CDM). Each type of storage device requires a CDM.

The installation program auto-detects many types of storage devices, such as IDE drives, SCSI drives, CD drives, and tape drives. If your storage device is not detected, select the appropriate driver from the list of available drivers provided with NetWare 6 or add a new driver from a diskette. CDMs can be obtained from the storage device manufacturer.

Selecting a Network Board

Network boards, such as the Novell NE3200™ board, require a software driver in order to communicate with the network. The software driver for a network board is called a *LAN driver*.

The installation program auto-detects many types of network boards. If your network board is not detected, select the driver for the network board from the list provided with NetWare 6 or add a new driver from a diskette. You can obtain LAN drivers from the network board manufacturer.

Editing the Properties of the Network Board (If Required)

The network board must be installed and configured correctly. Properties such as interrupt, port value, and slot must not conflict with any other device in the computer. If you need specific network board properties, contact the network board manufacturer.

Loading a NetWare Loadable Module (If Required)

Some server and network configurations require you to load a NetWare Loadable Module (NLM) program before completing the server installation. For example, you can load ROUTE.NLM for installing in a token ring environment.

Creating a NetWare Partition and Volume SYS:

Partitions correspond with operating systems, such as NetWare, DOS, or UNIX. Partitions divide a large storage region into smaller, more manageable sections. A single storage device can contain up to four partitions.

You can divide NetWare partitions into smaller sections called volumes. Each NetWare partition can contain up to eight volumes.

To create a NetWare partition and volume SYS:, you must

- ◆ Remove an existing volume SYS: (conditional)
- ◆ Create a NetWare partition
- ◆ Create volume SYS:
- ◆ Set the size of the NetWare partition and volume SYS: (if required)
- ◆ Modify the properties of volume SYS: (if required)

Removing an Existing Volume SYS: (Conditional)

If the computer already has a volume SYS: from a previous installation, the volume and all its data will be deleted.

IMPORTANT: To retain the data on volume SYS:, you should exit and restart the installation program and select Upgrade from the Type of Installation screen.

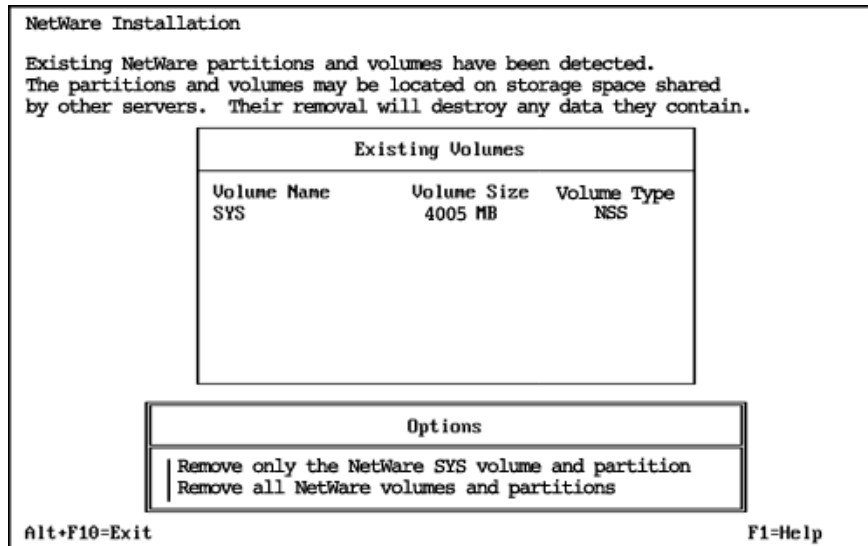

When removing volume SYS: during a new server installation, you must choose one of the following options:

- ♦ **Replace Volume SYS: and its NetWare Partition**—This removes the existing volume SYS: as well as the entire NetWare partition containing volume SYS:. Any volume that is part of the NetWare partition that contains volume SYS: is also removed—even if the volume spans to other NetWare partitions.
- ♦ **Remove All NetWare Volumes and NetWare/NSS Partitions**—This removes all NetWare volumes and all NetWare/NSS partitions.
- ♦ **Remove All but Shared Volumes and Partitions**—This option is available only if shared storage has been detected on the server.

Any option will remove only NetWare partitions. Other types of partitions, such as DOS, UNIX, and system/utility partitions will not be removed.

Creating Volume SYS:

During the initial stages of installation, the installation program guides you through the steps to create a single NetWare partition containing volume SYS:. It is created as a Novell Storage Services (NSS) volume, which has many advantages over a traditional volume.

The NetWare 6 operating system requires a volume SYS: that meets the requirements specified in “[System Requirements](#)” on page 27.

The screenshot shows a window titled "NetWare Installation" containing a dialog box titled "Volume SYS and Partition Properties". The dialog box lists the following information:

Device:	SEAGATE ST32550M rev:0019 [U312-A0-D0:0]
Filesystem Type:	NSS
NetWare Partition Size (MB):	1019.8
Volume SYS Size (MB):	1015.9
File Compression:	Off
NOTE: Press F1 for size recommendations.	

Below the dialog box is an "Options" box with two buttons: "Continue" and "Modify".

At the bottom left of the window is the text "Alt+F10=Exit" and at the bottom right is "F1=Help".

Volume SYS: Size—The size that you specify for the NetWare partition will be used for the size of volume SYS:.

To modify the volume SYS: size, in the Options box select Modify. Select the appropriate storage device. Select the NetWare Partition Size field and press Enter. Backspace over the current size. Type the new size and press Enter. The size of volume SYS: will change accordingly. Press F10 to save the settings and continue.

If you plan to have additional volumes on the server, remember to reduce the size of the NetWare partition and volume SYS: so that the appropriate amount of disk space is available for other volumes.

Additional volumes can be created later during the installation program or after completing the installation using ConsoleOne™.

HINT: Although an NSS volume SYS: is recommended for most server installations, you can create a traditional volume SYS: by pressing **Setting Up NetWare 6** **47**

Summary

NetWare system files will now be copied to volume SYS:.

If you are installing from the network, you will be prompted to reconnect to the network. To continue the installation, enter the password for the user that originally logged in.

The NetWare installation program will continue in graphical display mode.

Naming the Server

The NetWare server name must be unique from all other servers on the eDirectory tree. The name can be between 2 and 47 alphanumeric characters and can contain underscores (_) and hyphens (-), but no spaces. The first character cannot be a period (.).

IMPORTANT: The server name must be different from the name that you plan to use for the eDirectory tree.

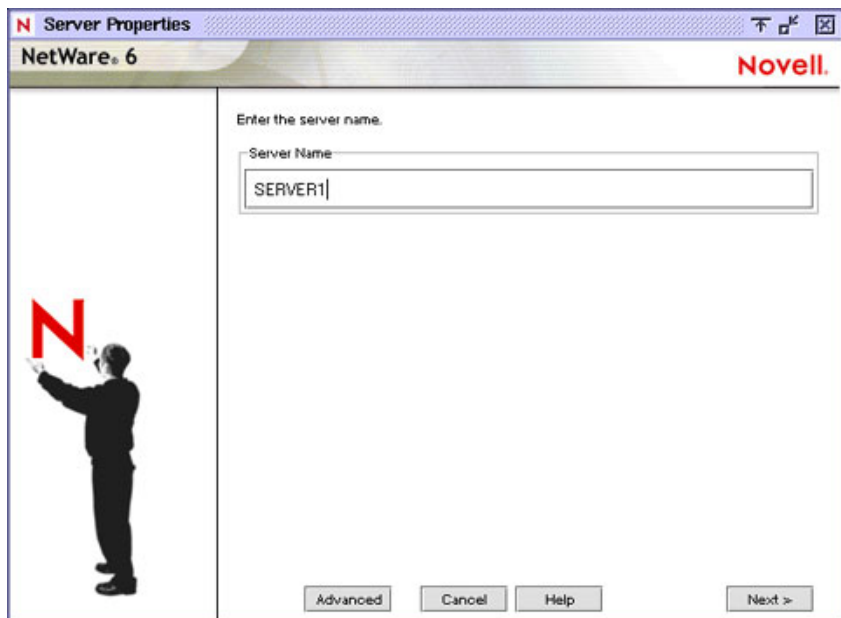

Although a mouse is recommended, you can use the keyboard commands in [Table 1](#) to navigate through the installation program. Use the arrow keys on the numeric keypad for cursor movements.

HINT: NumLock (number lock) must be on in order for cursor movements to be enabled on the keypad.

Table 1 **Graphical Mode Keyboard Actions**

Keystroke	Action
Tab	Move to next element
Shift+Tab	Move to previous element
Enter	Select
Ctrl+Tab	Move to next text area
Up-arrow (keypad 8)	Move cursor up
Down-arrow (keypad 2)	Move cursor down
Right-arrow (keypad 6)	Move cursor right
Left-arrow (keypad 4)	Move cursor left
Hold Shift while pressing keypad	Accelerate cursor movement
Keypad 5	Select or click an object
Keypad 0	Lock a selected object (for dragging)
Keypad . (period)	Unlock a selected object (to drop)
Keypad + (plus)	Double-click an object
Alt+F7	Move to next window
Alt+F8	Move to previous window

Enabling Cryptography

Some technologies require the use of cryptography. To enable cryptography, you must provide a cryptographic file (.NFK) which is located on the *NetWare 6 License/Cryptography* diskette.

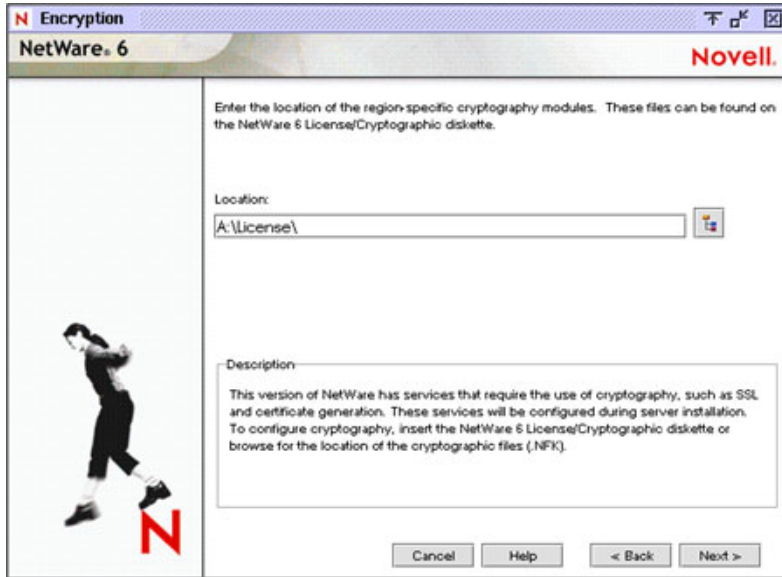

To enable cryptography, insert the *NetWare 6 License/Cryptography* diskette, browse to the License directory, and select the .NFK file.

Installing the NetWare Server File System

The server should now have a NetWare partition and one volume named SYS:. If you have space available for creating additional partitions and volumes, you can create them now.

NOTE: If you have allocated all available space to volume SYS:, you will not be prompted for NetWare server file system information. You can skip to [“Installing Networking Protocols” on page 54](#).

When installing the NetWare file system, you can

- ◆ Create additional volumes
- ◆ Modify volumes
- ◆ Delete volumes

Understanding Volumes

Volumes allow you to subdivide your partitions into more manageable sections. Additional volumes can be created from any available free space on

a storage device. Volume names can be between 2 and 15 characters. Valid characters include A through Z, 0 through 9, and characters _ ! - @ # \$ % & (). The volume name cannot begin with an underscore (_) or have two or more consecutive underscores.

You can create two types of volumes—Novell Storage Services (NSS) volumes or traditional volumes.

- ♦ **NSS volume**—NSS is advanced file system technology that enhances the management of large files, large volumes, namespaces, and storage devices. The time required to mount large volumes is significantly reduced with NSS.
- ♦ **Traditional NetWare volume**—Although not recommended, Traditional NetWare volumes might be required to use data migration, File Transfer Protocol (FTP), VREPAIR, Network File System (NFS), or file name locks.

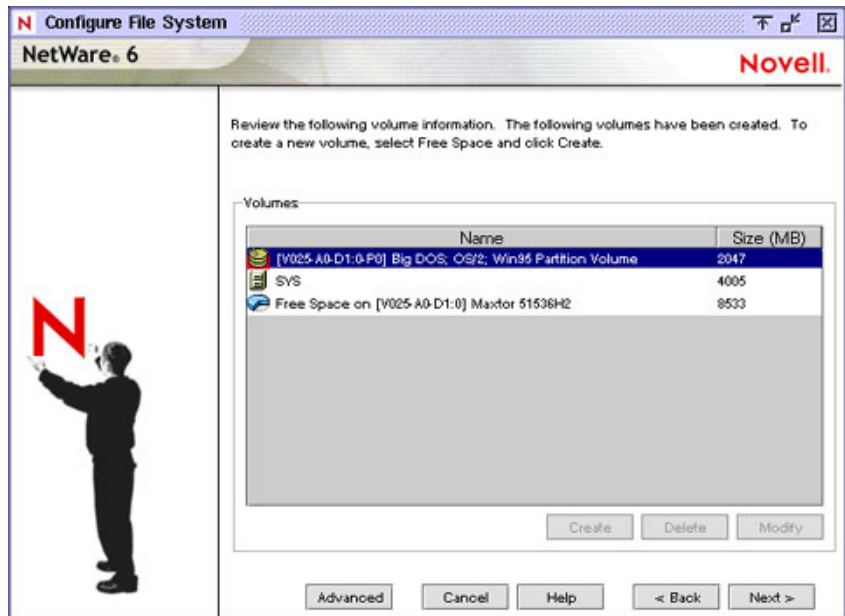

Creating Volumes

Volumes are created from free space. A large disk can be divided into several volumes during installation. Conversely, a volume can be distributed over multiple disks.

WARNING: Creating a volume that spans two or more storage devices is not recommended. If a volume spans disk devices and one of the devices fails, all data on the entire volume could be lost.

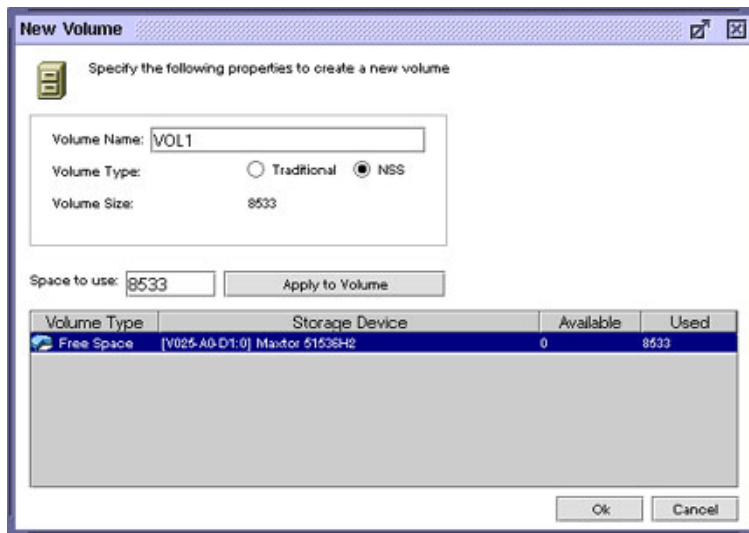

To create a volume, select Free Space and click Create. Type the name of the volume and click OK.

To allocate only a portion of the selected free space to the volume, type the amount of space to use and click Apply to Volume.

Modifying Volumes

The size of any existing volume can be increased but not decreased. To decrease the size of an existing volume, the volume must be deleted and re-created.

To add to the size of a volume, select an additional free space, type the amount of space to use, and click Apply to Volume.

Deleting Volumes

You can delete any volume you have created except volume SYS:. When a volume is deleted, all data on the volume is lost.

Mounting Volumes

In order for volumes to be accessed by NetWare, they must be mounted. Volumes can be mounted immediately or at the end of installation.

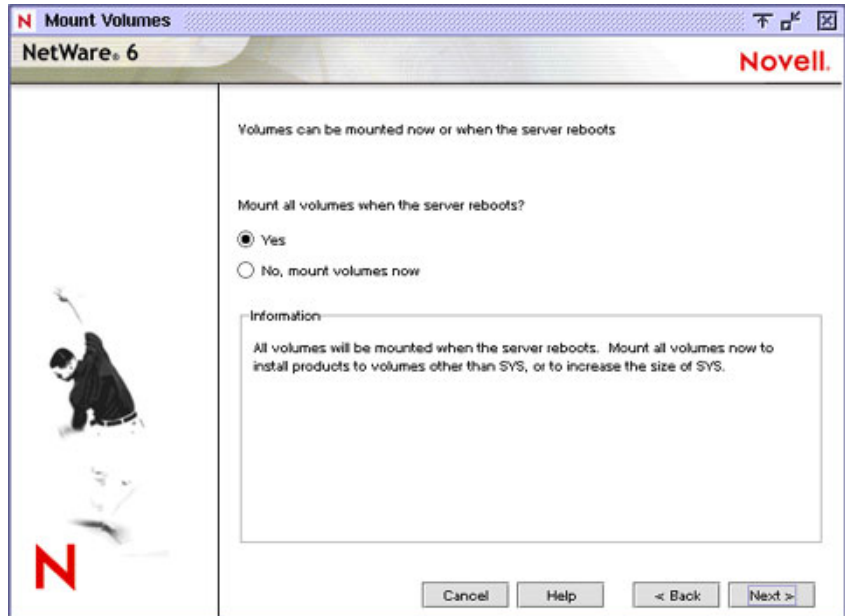

- ◆ **Mount Volumes Now**—You should mount volumes now if you plan to install additional products and services, such as documentation, on volumes *other* than volume SYS:. You should also mount volumes that you might be moving forward from a previous NetWare server so they can be updated.
- ◆ **Mount Volumes after Installation Completes**—If you are installing products and services on volume SYS: only, you can wait to mount volumes after the installation program completes.

Upgrading a NetWare Server with NSS Volumes

If you are upgrading a NetWare server with NSS volumes, the NSS volumes will not appear or mount until they are updated. Updating NSS volumes is done after finishing the server upgrade by following the instructions in [“Updating NSS Volumes” on page 103](#).

Installing Networking Protocols

NetWare 6 can process IP (Internet Protocol) network packets and traditional IPX (Internetwork Packet Exchange™) packets. Both protocols can be assigned to a single network board, which allows the server to communicate using IP and IPX.

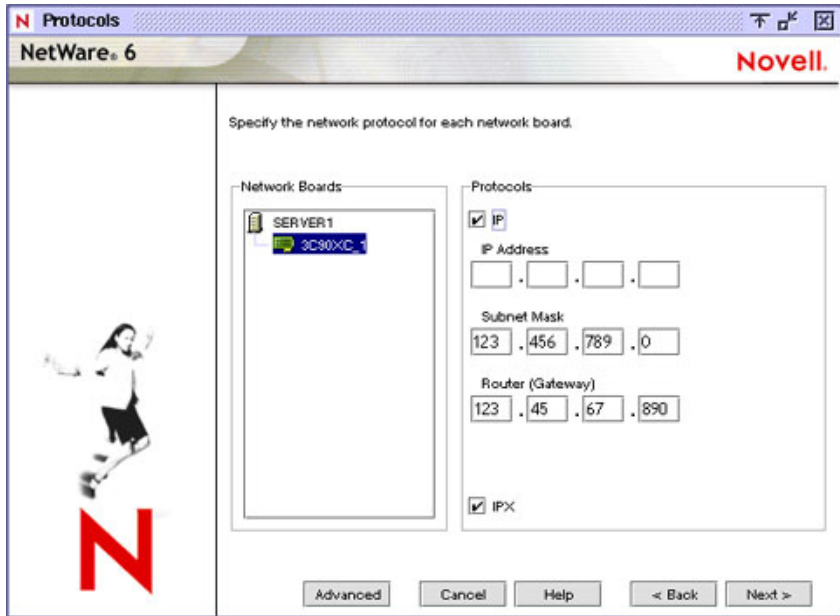

To install IP, click a network board and then check the IP check box. Enter the required IP information. To install IPX, click a network board and then check the IPX check box.

If you choose to install IP and not IPX, the SERVERID reference is not used and is removed from the AUTOEXEC.NCF file. You can add IPX after the server installation by adding the **SERVERID 8_digit_number** command after the **SERVERNAME** command in the AUTOEXEC.NCF file.

About Internet Protocol (IP)

Internet protocol (IP) lets your network share data with other IP networks, including the Internet. Using IP requires a unique IP address, a subnet, and a router or gateway address.

- ♦ **IP Address**—Identifies each device on the network. The address consists of 32 bits, which are represented as decimal values separated by periods, such as 123.45.67.89.

If your server will connect to the Internet, you must obtain a unique IP address. For information on receiving an IP address, contact your Internet service provider (ISP).

- ♦ **Subnet Mask**—Lets you break up your network into smaller networks. Your network might have too many nodes or might be too geographically dispersed to manage as a single network.

Dividing your network into smaller networks allows the network routers to filter and reduce the network activity seen by any of the nodes. However, dividing your network and using several network addresses might not be appropriate on a large network that needs to appear to network administrators as a single network.

- ♦ **Router (Gateway)**—The address of the router that connects two different environments, such as a LAN and the Internet.

You can enter a specific router (gateway) address or you can rely on the network to automatically find the nearest router. If you specify the address, remember that the router must exist on your network segment.

Installing IP will automatically bind to the Ethernet_II frame type.

When IP is selected, passive support for IPX is also provided. If an IPX request arrives at the server, NetWare will process the IPX request. This passive support for IPX is called Compatibility Mode and is automatically enabled to provide service for applications that require IPX.

HINT: You can disable Compatibility Mode by removing the `LOAD SCMD` command from the server's `AUTOEXEC.NCF` file. When IPX Compatibility Mode is disabled, the server will process only IP packets. Applications that require IPX will not function properly.

About IPX

Novell's traditional protocol, Internetwork Packet Exchange (IPX), lets you continue using IPX-based applications. If IPX, but not IP, is installed on your server, it will actively process IPX packets and ignore packets using other protocols, such as IP.

During the installation program, existing IPX frame types will be detected. The installation program will detect one of the following conditions.

- ♦ **A single IPX frame type**—If a single frame type is detected, it will be installed.
- ♦ **Multiple IPX frame types**—If detected, you will be prompted to choose the frame types that you want to install.
- ♦ **No IPX frame types**—If no frame types are detected, `Ethernet_802.2` will be installed by default.

Using Both IP and IPX

If you have network clients or applications that require IPX and IP, you can install both protocols. Both protocols can be bound to a single network board. When selected, both IP and IPX protocols are actively supported. The server will process IP requests using IP, and it will broadcast and reply to IPX requests using IPX.

Setting Up Domain Name Service

The IP protocol identifies computers and systems by their assigned IP addresses, such as `123.45.56.89`. Domain Name Service (DNS) allows a specific server on the network to maintain a list of simple, readable names that match IP addresses. Applications (or protocols) that require IP addresses rather than names can use a DNS server to translate from one form to another.

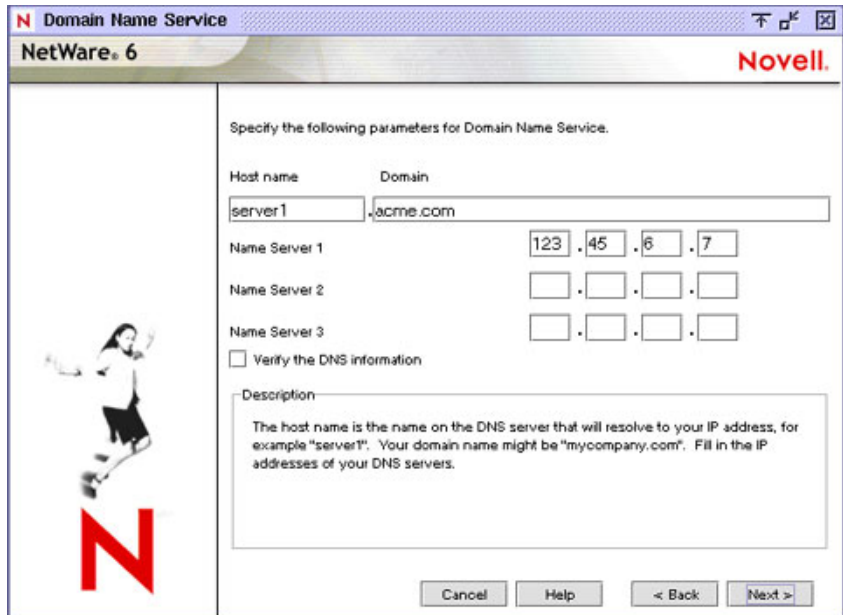

HINT: If this server will not be available to the Internet, you can skip this screen and ignore any associated error messages.

If you want this server to be available to the Internet, you must enter the following:

- ♦ **Host Computer**—The simple, readable name on the DNS server that matches this NetWare server's name (or the name that you have bound to the network board).

HINT: Set up the host computer name on the DNS server to use the NetWare server name.

- ♦ **Domain Name**—The hierarchical name that represents the organization of your network, such as acme.com.
- ♦ **Domain Name Server**—The IP address of the DNS server that maintains the list containing this NetWare server's simple, readable name and IP address. For more information, contact your network administrator or Internet service provider.

Configuring a NetWare Server as a DNS Server (Optional)

In addition to standard services, a NetWare server can be configured to provide DNS services. The DNS Server setup is done after completing the NetWare server installation.

Setting the Server Time Zone

The server time and time zone are important in order to synchronize network events. Advanced time synchronization settings are available during the Customize section of the installation.

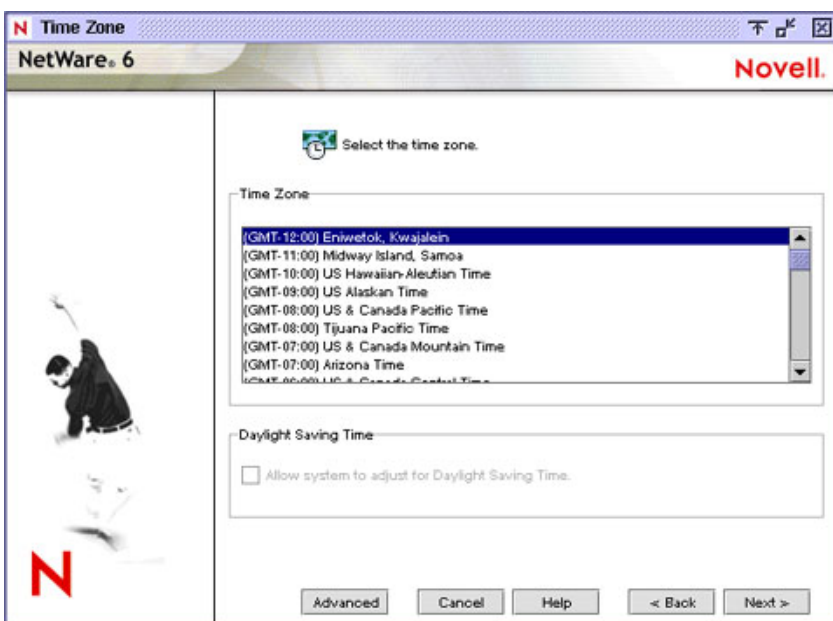

Setting Up Novell eDirectory

Novell eDirectory provides global access to all networking resources. eDirectory allows users with the proper access rights to log in to the network and view and access network resources.

Network resources such as servers and printers are presented hierarchically in an eDirectory tree. Users log in to the eDirectory tree with a single login name and password instead of logging in to specific servers.

Choosing the Type of eDirectory Installation

To set up eDirectory, you must choose one of the following options:

- ◆ Install the server into an existing eDirectory tree
- ◆ Create a new eDirectory tree

Before completing this task, you should understand the concepts relating to eDirectory trees, containers, and context.

- ◆ **Tree Name**—The top level of the available network resources and must be unique from other eDirectory tree names on the network.
- ◆ **Containers**—Much like subdirectories, containers contain network objects. The server can be installed into two types of container objects: Organization (O) and Organizational Unit (OU).
- ◆ **Context**—The context, much like DOS directory paths, denotes the full path of a network object in the eDirectory tree. For example, a NetWare server might be installed into an Organizational Unit (OU) named Sales under the Organization (O) named Acme. The context would be denoted as OU=Sales.O=Acme or Sales.Acme.

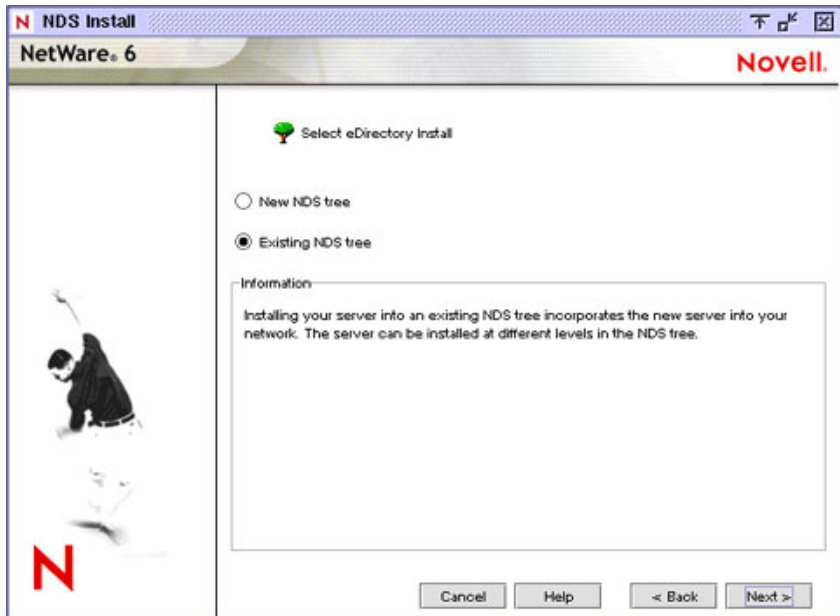

Install the Server into an Existing eDirectory Tree

Installing your server into an existing eDirectory tree incorporates the server into your network.

The server can be installed in any Organization (O) or Organizational Unit (OU) container in the eDirectory tree where you have the Supervisor right. You can create containers during the installation program. You will be required to log in and provide the context, username, and password for the user with the Supervisor right to the container.

IMPORTANT: If this is the first NetWare 6 server to be installed into an existing eDirectory tree, you should have already completed the Network Preparation section of the NetWare Deployment Manager utility.

NetWare Deployment Manager (NWDEPLOY.EXE) is located on the *NetWare 6 Operating System* CD and is run from a Windows workstation.

If you have updated the eDirectory tree on all servers but have not yet prepared the network for NDS 8, you will be prompted to modify the schema. When prompted, you must provide the administrator name and password for the entire eDirectory tree.

Creating a New eDirectory Tree

Create a new tree if you are creating a new network or if this server requires a separate eDirectory tree. The resources available on the new tree will only be available to users logged in to the new tree.

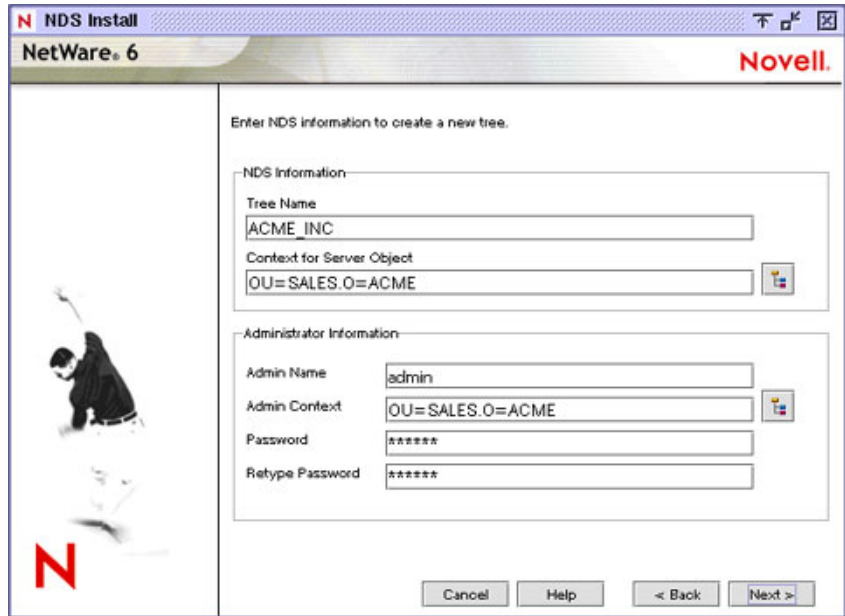

NDS Install
NetWare 6
Novell

Enter NDS information to create a new tree.

NDS Information:

Tree Name: ACME_INC

Context for Server Object: OU=SALES.O=ACME

Administrator Information:

Admin Name: admin

Admin Context: OU=SALES.O=ACME

Password: *****

Retype Password: *****

Cancel Help < Back Next >

Each eDirectory tree must have a name unique from other eDirectory trees on the network. You will also be prompted to create a user (default name Admin) with the Supervisor right, identify an eDirectory context, and assign a password.

Summary

Now that you have created a new eDirectory tree or installed the server into an existing eDirectory tree, the NetWare Server object and Volume objects will be installed in the container you specified.

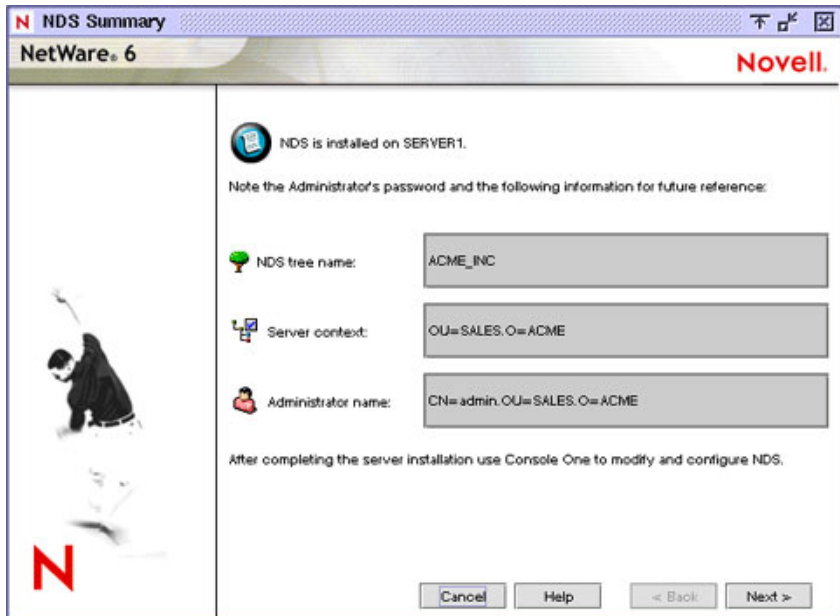

If you have created a new eDirectory tree, a user (default name Admin) with Supervisor rights to the eDirectory tree will be created in the same eDirectory container as the NetWare Server object.

IMPORTANT: Record the administrator password and other relevant information before proceeding.

Licensing the NetWare Server

NetWare 6 must have a valid license in order to function as a server. You can install the license from the *NetWare 6 License/Cryptography* diskette or browse to a directory that contains NetWare 6 licenses.

If you already installed a license at the beginning of the installation, you can choose to use that license, or install a different one.

Install without Licenses—Although the server can be installed without a license, the unlicensed server will allow only two user connections. After installation, you can use the Novell iManager utility to install additional licenses.

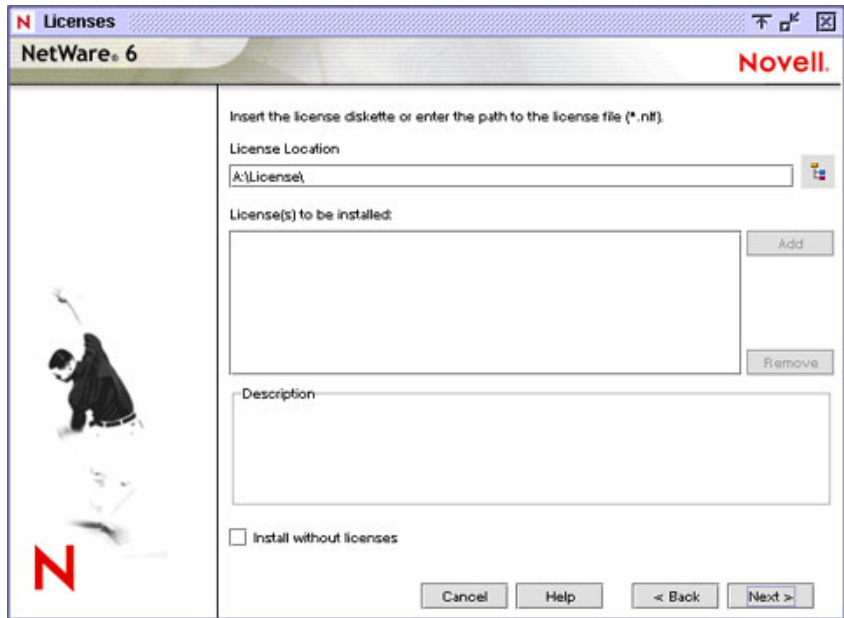

If prompted, select where in the tree you want to install the license.

Install Networking Products

After completing the NetWare server portion of the installation, you can select other networking products to install. Other networking products provide enhanced functionality, such as network management and Internet access, to NetWare 6.

NOTE: Some products can be installed only by using NetWare Deployment Manager after the server installation is complete.

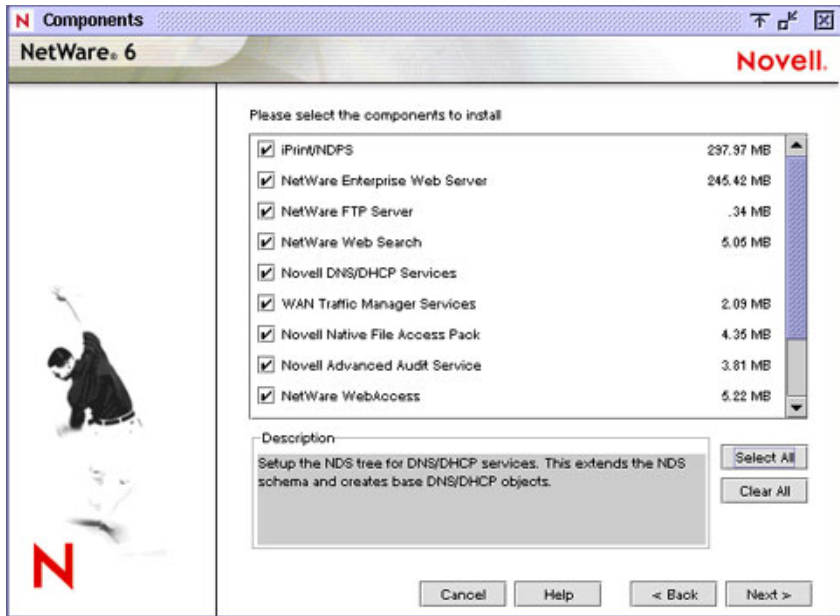

Although you can choose which products to install, installing the products that are already selected by default will ensure that you receive the features recommended for NetWare.

For more information on NetWare products, see [Chapter 1, “Welcome to NetWare 6,”](#) on page 11.

Depending on the products selected to be installed, you may need to complete the steps in the following sections. Although the products are installed, many require additional configuration after completing the server installation.

For more information on configuration requirements for specific products, refer to each product documentation as part of the NetWare 6 documentation at the [NetWare 6 Documentation site \(http://www.novell.com/documentation/lg/nw6p/index.html\)](http://www.novell.com/documentation/lg/nw6p/index.html).

Configuring IP-Based Services (Conditional)

If the Port Resolver detects a potential port conflict (two or more services using the same port on the same IP address) it displays the Configure IP-based Services dialog box. This dialog box contains configuration fields for each

service it manages that is selected to be installed, or that was previously installed. The configuration fields include IP address, host name, non-secure port, and secure port.

The first time the dialog box displays, it defaults to Single IP Address configuration mode. If the dialog box displays again later, either by returning to it or in a subsequent post install, it uses the previous configuration mode and retains any previous values input by the user.

Single IP Address Configuration

The following figure shows the Port Resolver dialog in Single IP Address configuration mode. This example shows all four of the services (or service groups) managed by Port Resolver, namely, NetWare Enterprise Web Server, Apache-based Services (NetStorage, NetWare Web Access, and NetWare Web Search), Novell iFolder Storage Services, and iPrint/NDPS.

Figure 1 Single IP Address configuration mode

The screenshot shows a dialog box titled "Configure IP-based Services" with a close button (X) in the top right corner. The main text reads: "You have selected to install multiple IP-based services that are typically installed on separate servers. You can use a single IP address for these services if you modify the default port numbers, or you can retain the default port numbers and specify multiple IP addresses. Please click Help for additional information." Below this text are two radio buttons: "Single IP Address" (selected) and "Multiple IP Addresses". There are four service groups, each with a checked checkbox and a row of input fields for IP address and ports. The IP address field is split into four segments: 137, 65, 71, and 52. The host name field contains "pthomas2.provo.novell.com". The ports are split into two segments: a non-secure port and a secure port. At the bottom, there is a checkbox labeled "Reserve 137.65.71.52:443 to use for secure printing" which is unchecked. At the very bottom are three buttons: "Help", "< Back", and "Next >".

Service Group	IP Address	Non-secure Port	Secure Port
NetWare Enterprise Web Server	137.65.71.52	80	443
Apache-based Services	137.65.71.52	51080	51443
Novell iFolder Storage Services	137.65.71.52	52080	52443
iPrint/NDPS	137.65.71.52	631	443

In Single IP Address configuration mode, the Port Resolver sets the IP address and host name fields to the server's primary IP address and host name and disables these fields. The non-secure and secure port number fields are

enabled and set to default values. Services are defaulted to their preferred port configurations unless a particular port number is already assigned to another service. If the preferred port number is already used, the Port Resolver sets the port number to a secondary default.

In Single IP Address configuration mode, the Port Resolver assigns preferred port numbers based on the following priorities:

1. If a service has been previously installed, and is not being reinstalled, the Port Resolver displays its configuration and disables the configuration fields. In the case of Apache-based Services, even if one or more services are being reinstalled, the Port Resolver does not allow the previous configuration to be changed. This prevents a service that is being installed from changing the configuration of a service that has already been installed.
2. If the user selects to install iPrint/NDPS and checks the Reserve *ip address:secure port* to use for secure printing check box, the Port Resolver reserves port 443 on the primary IP address; it does not allow it to be assigned to any other service. The IP configuration of the iPrint/NDPS service cannot be configured during the installation, so it cannot be assigned a different IP address or port number. If another service is assigned port 443 on the primary IP address, the user will not be able to enable secure printing on the server while the other service is running.
3. If the user selects to install NetWare Enterprise Web Server, the Port Resolver assigns it ports 80 and 443. These are the standard http and https ports for web servers. If port 443 has been reserved for the iPrint/NDPS service, the Port Resolver uses a secondary default for the secure port number.
4. If the user selects to install any of the Apache-based Services, the Port Resolver assigns them ports 80 and 443, if these ports are not already assigned. If the Port Resolver has already assigned them as the default ports for another service, it uses secondary default port numbers for the Apache-based Services.
5. If the user selects to install Novell iFolder Storage Services, the Port Resolver will only assign it ports 80 and 443 if it is the only service managed by the Port Resolver that the user has selected to install.

Multiple IP Addresses Configuration

The following figure shows the Port Resolver dialog box in Multiple IP Addresses configuration mode. This example shows all four of the services (or service groups) managed by Port Resolver, namely, NetWare Enterprise Web Server, Apache-based Services (NetStorage, NetWare Web Access, and NetWare Web Search), Novell iFolder Storage Services, and iPrint/NDPS.

Figure 2 Multiple IP Address configuration mode

The screenshot shows a dialog box titled "Configure IP-based Services" with a close button (X) in the top right corner. The main text reads: "You have selected to install multiple IP-based services that are typically installed on separate servers. You can use a single IP address for these services if you modify the default port numbers, or you can retain the default port numbers and specify multiple IP addresses. Please click Help for additional information." Below this text are two radio buttons: "Single IP Address" (unselected) and "Multiple IP Addresses" (selected). There are four service groups, each with a checked checkbox and a corresponding IP address and port configuration row. The first row is for "NetWare Enterprise Web Server" with IP 137.65.71.53 and ports 80 and 443. The second row is for "Apache-based Services" with IP 137.65.71.54 and ports 80 and 443. The third row is for "Novell iFolder Storage Services" with IP 137.65.71.55 and ports 80 and 443. The fourth row is for "iPrint/NDPS" with IP 137.65.71.52 and ports 631 and 443. At the bottom, there is a checked checkbox labeled "Reserve 137.65.71.52:443 to use for secure printing" and three buttons: "Help", "< Back", and "Next >".

In Multiple IP Addresses configuration mode, the Port Resolver configures services with their preferred IP configuration if it is not already used. If the preferred configuration is used, the Port Resolver will assign the preferred port numbers and assume the service will be using an IP address other than the primary IP address. If the server has multiple bound IP addresses (multiple NIC cards), it will, by default, assign one of those IP addresses. If no additional bound IP addresses are available, the user must specify a unique secondary IP address or unique port numbers.

Secondary IP addresses must be in the same subnet as the IP address bound to a NIC card in the server. The subnet is identified by performing a bitwise AND operation on the bound IP address and its corresponding subnet mask.

For example, the valid secondary IP addresses for the IP address 137.65.70.44 with a subnet mask of 255.255.252.0 are in the range 137.65.68.xxx to 137.65.71.xxx.

If no bound IP addresses remain that the Port Resolver has not assigned, the Port Resolver performs a bitwise AND operation on the primary IP address and the subnet mask and places the results in the IP address configuration field as a partial IP address. The intent is to simplify the entering of secondary IP addresses and to guide the user in selecting a valid secondary IP address.

In Multiple IP Address configuration mode, the Port Resolver assigns preferred configurations based on the following priorities:

1. If a service has been previously installed, and is not being reinstalled, the Port Resolver displays its configuration and disables the configuration fields. In the case of Apache-based Services, even if services are being reinstalled, the Port Resolver does not allow the previous configuration to be changed. This prevents a service that is being installed from changing the configuration of a service that has already been installed.
2. If the user selects to install iPrint/NDPS and checks the Reserve *ip address:secure port* to use for secure printing check box, the Port Resolver reserves port 443 on the primary IP address; it does not allow it to be assigned to any other service. The IP configuration of the iPrint/NDPS service cannot be configured during the installation, so it cannot be assigned a different IP address or port number. If another service is assigned port 443 on the primary IP address, the user will not be able to enable secure printing on the server while the other service is running.
3. If the user selects to install NetWare Enterprise Web Server, the Port Resolver attempts to assign it ports 80 and 443 (the standard http and https ports for webb servers) o the primary IP address. If the primary IP address is already assigned, it assigns an additional bound IP address, if available, or displays a partial secondary IP address for the user to complete.
4. If the user selects to install any of the Apache-based Services, the Port Resolver attempts to assign it ports 80 and 443 (the standard http and https ports for webb servers) o the primary IP address. If the primary IP address is already assigned, it assigns an additional bound IP address, if available, or displays a partial secondary IP address for the user to complete.
5. If the user selects to install Novell iFolder Storage Services, the Port Resolver will only assign it ports 80 and 443 on the primary IP address if it is the only service managed by the Port Resolver that the user has selected to install. Otherwise, it assigns an additional bound IP address, if

available, or displays a partial secondary IP address for the user to complete.

For each secondary IP address `xxx.xxx.xxx.xxx` specified by the user, the Port Resolver adds the following line to the `autoexec.ncf`:

```
add secondary ipaddress xxx.xxx.xxx.xxx
```

If performing a post install, the Port Resolver also executes the command on the console.

For more information on default port assignments, which ports can be reassigned, and which ports cannot be reassigned, see "[Port Number Assignments](#)" in Getting Results with Novell Web Services.

Installing Novell Certificate Server

Novell Certificate Server enables secure data transmissions and is required for Web-related products such as NetWare Web Manager and NetWare Enterprise Web Server. It also allows you to mint, issue, and manage digital certificates by creating a Security container object and an Organizational Certificate Authority (CA) object.

If the network does not already have an Organizational CA object, the first NetWare 6 server will automatically create and physically store the Security container object and Organizational CA object for the entire eDirectory tree. Both objects are created at, and must remain at the [Root] of, the eDirectory tree.

Only one Organizational CA object can exist in an eDirectory tree. Once the Organizational CA object is created on a server, it cannot be moved to another server. Deleting and re-creating an Organizational CA object will invalidate any certificates associated with the Organizational CA.

Make sure that the server that you intend to permanently host the Organizational CA object and will be a reliable, accessible, and continuing part of your network.

To create the Security container object and the Organizational CA object, you must be logged in as a user with rights at [Root] of the eDirectory tree.

If the Organizational CA object already exists on the network, the installation program will find and reference the server that holds it. The installation

program will access the Security container and create a Server Certificate object.

To access the Security container and create a Server Certificate object, you must be logged in as a user with the Read right to the existing Security container object.

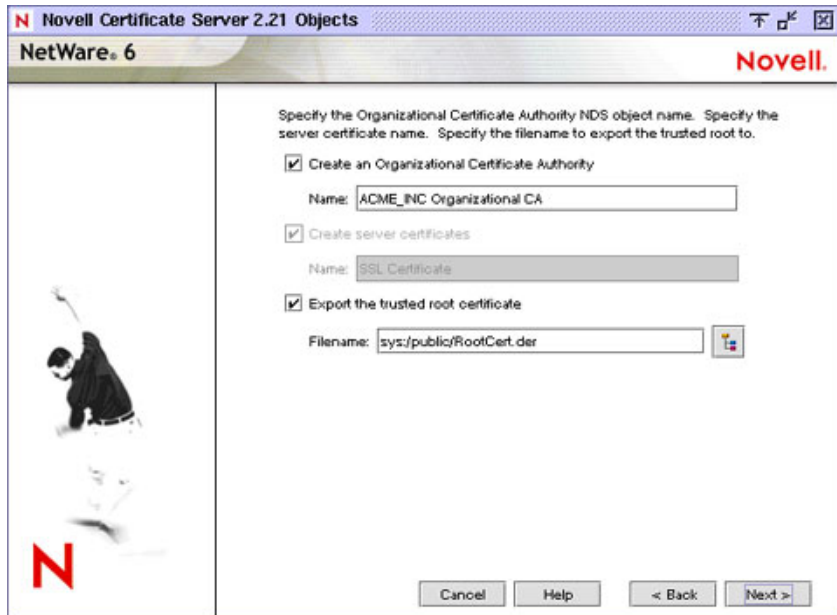

If an Organizational CA object is not available on the network, Web-related products such as NetWare Web Manager and NetWare Enterprise Web Server will not function.

Configuring LDAP

During the installation, you can configure TCP and SSL port numbers for LDAP services. By using ConsoleOne, you can also configure ports after the installation.

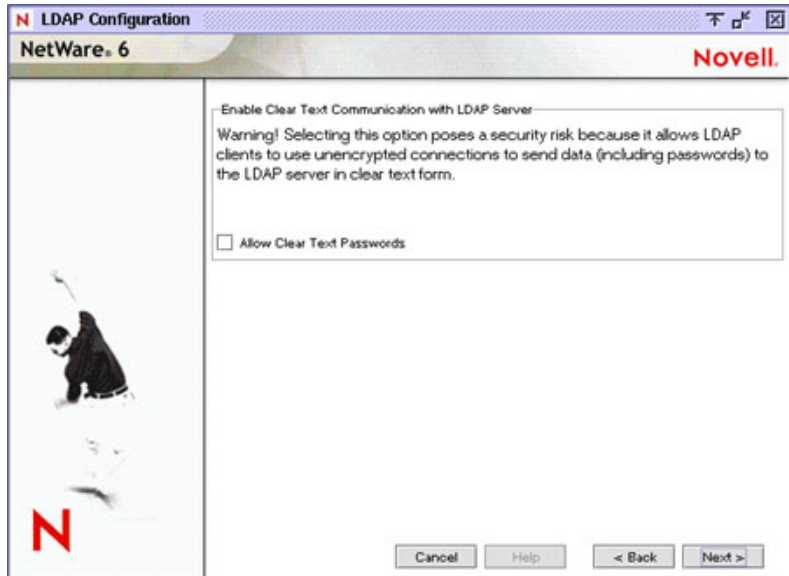

By default, the Allow Clear Text Passwords option is unchecked. This default setting doesn't allow clear-text passwords. eDirectory user binds on non-SSL connections are disabled. Any sent password, however, is received by the server before the bind fails. Therefore, it is possible for an eDirectory username and password to be captured during a failed bind attempt.

Also by default, only passwords exchanged over SSL connections are encrypted. If you check the Allow Clear Text Passwords check box, requests that include passwords can be transmitted over nonencrypted connections. Nonencrypted passwords can be captured by network monitoring equipment. Therefore, depending on the environment, clear-text passwords can pose a security risk.

Encryption is a process of converting or hashing information being sent and then undoing that conversion or hash. Encrypted connections (using SSL) are secure, but the overhead makes this option slower. Clear-text connections are faster, but passwords aren't secure.

If sensitive information does not travel over the network, you might not require an SSL connection.

Scenario 1 -- Communication Occurs on the Same Server

Novell Portal Services (NPS) and LDAP Services are running on the same server DAir15. NPS uses LDAP for communication between NPS and LDAP. Because both servers are running on DAir15, the information (for example, passwords) doesn't travel over the network. Encryption is unnecessary. You check the Allow Clear Text Passwords check box because clear text is faster than encrypted text.

Figure 3 Scenario 1

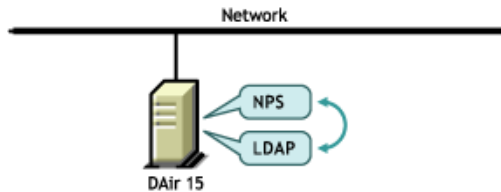

Scenario 2 -- Communication Goes over the Network

Novell Portal Services is running on server DAir15, and LDAP Services is running on a separate server, DAir28. NPS uses LDAP for communication between NPS and LDAP. Because the information travels over the network, encryption is necessary. You don't check the Allow Clear Text Passwords check box. The encrypted information is slower than a clear-text connection, but the information is secure.

Figure 4 Scenario 2

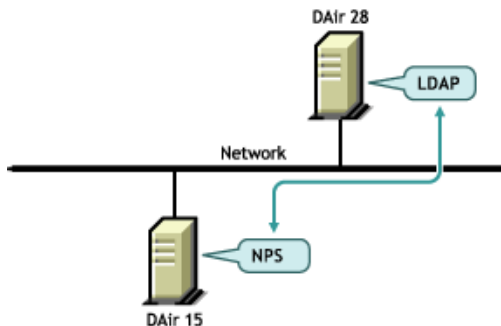

For additional information on configuring LDAP Services, see [Installing or Upgrading eDirectory on Windows NT/2000 Server](http://www.novell.com/) (<http://www.novell.com/>)

<documentation/lg/edir87/edir87/data/a2qqr6x.html>). Click the Installing or Updating eDirectory link, then click the Communicating with eDirectory through LDAP link.

Installing Novell Native File Access Protocols

Novell Native File Access Pack lets Macintosh, Windows, and UNIX workstations access and store files on NetWare servers without having to install any additional software—such as Novell Client software. The software is installed only on the NetWare server and provides "out of the box" network access. Just plug in the network cable, start the computer, and you have access to servers on your network. No client configuration, no client software, no problem.

About Native Protocols

Novell Native File Access Pack software enables the NetWare server to use the same protocol (referred to as "native") as the client workstation to copy, delete, move, save, and open files. Windows workstations perform these tasks using the native Common Internet File System (CIFS) protocol, and Macintosh workstations use the native Apple* Filing Protocol (AFP). UNIX computers use the NFS protocol.

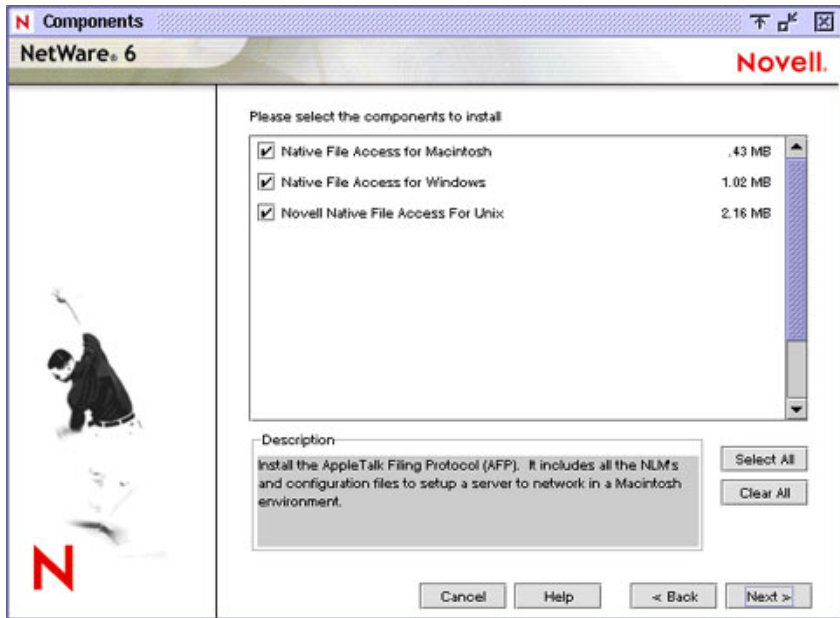

User Benefits of Novell Native File Access Protocols

Enabling native protocols on NetWare means that users can access files, map network drives, and create shortcuts to NetWare servers using the native methods available in their specific operating system. Windows users can use their familiar Network Neighborhood. Macintosh users can use Chooser or the Go menu to access network files and even create aliases. Because the NetWare server is running native protocols, users can copy, delete, move, save, and open network files—just like they would if they were working locally.

Setting Server Properties for Windows Workstations

You can decide how the NetWare server appears to Windows workstations by configuring the NNFAP Server Name, NNFAP Server Comment, and Unicode settings.

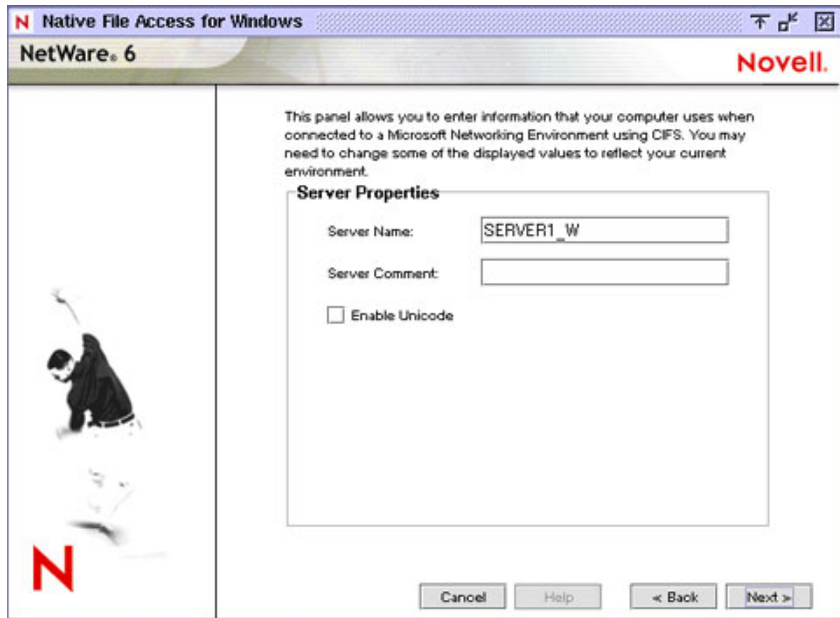

NNFAP Server Name

The name specified in the NNFAP Server Name field displays as the server name when Windows workstations without Novell Client software browse the network. You can change the name but it must be different than the NetWare Server name and no longer than 15 characters. The default NNFAP Server Name is the NetWare server name with an added underscore (`_`) and a W. For example, a NetWare server named SERVER1 defaults to a NNFAP server name of SERVER1_W.

NNFAP Server Comment

The text in the NNFAP Server Comment field displays when viewing details of the NNFAP server from a Windows workstation.

Enabling Unicode

When enabled, this command enables Unicode characters (used in double-byte languages). To support Unicode, an additional file named UNINOMAP.TXT must be created and saved in the SYS:\ETC directory.

When UNICODE is enabled, the UNINOMAP.TXT file is used to resolve Unicode-to-ASCII "no-map" problems. To specify "no-map" cases in the UNINOMAP.TXT file, enter the first Unicode value to watch for and then the second value representing the ASCII replacement code. For example:

```
0178 98
```

```
20AC CC
```

Save the values in the UNINOMAP.TXT file. If an unmappable character is encountered, the system uses the ASCII substitution character specified in the file.

Selecting an Authentication Method for Windows Workstations

Select one of the following:

- ◆ If users will authenticate using NDS, select Local.
- ◆ If users will authenticate using a Domain, select Domain.

For Windows users, there are two types of authentication methods available with Novell Native File Access: Local and Domain. Local authentication requires a simple password to log in to a NetWare server, but a simple password is not required for Domain authentication.

Local Authentication

The server running Novell Native File Access Protocol software performs the user authentication when clients are a member of a workgroup. With local authentication, the username and password on NetWare must match the username and password used to log in to the Windows workstation.

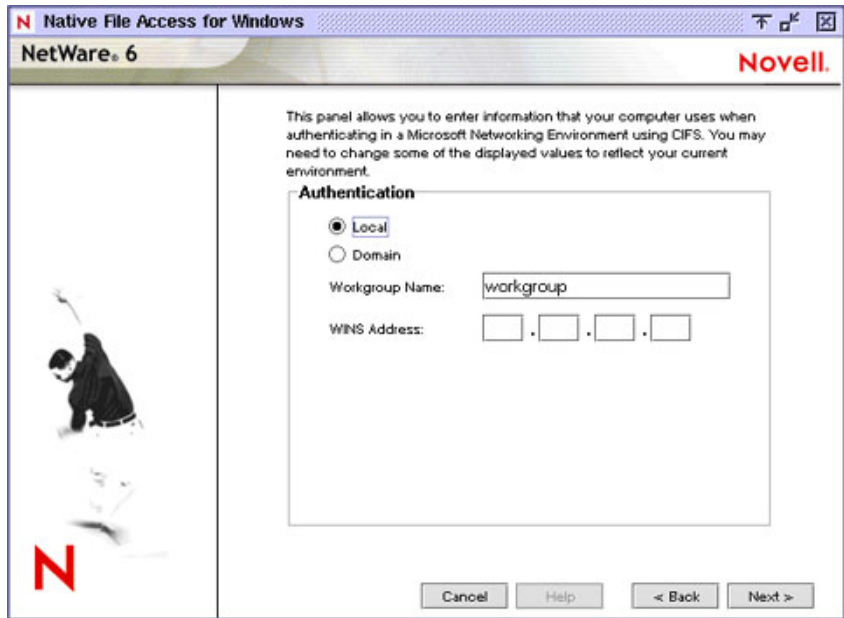

Workgroup Name: The domain or workgroup that the server will belong to. In this case, Workgroup and Domain are interchangeable.

WINS Address: Address of WINS server to be used to locate the primary domain controller (PDC), if the PDC and server running Novell Native File Access Protocols software are on different subnets.

Windows Internet Naming Service (WINS), part of the Microsoft Windows NT and 2000 Servers, manages the association of workstation names and locations with Internet Protocol (IP) addresses. WINS automatically creates and maintains a computer name and corresponding IP address mapping entry in a table. When a computer is moved to another geographic location, the subnet part of the IP address is likely to change. Using WINS, the new subnet information will be updated automatically in the WINS table.

Domain Authentication

A simple password is not required for domain authentication. Since the password is kept on the Windows domain controller, it is not possible to use Windows' native Change Password feature to change the password. Instead, you must use Windows' domain management utilities. To work properly, the

username and password on the domain controller must match the username and password used to log in to the Windows workstation.

Native File Access for Windows
NetWare 6
Novell

This panel allows you to enter information that your computer uses when authenticating in a Microsoft Networking Environment using CIFS. You may need to change some of the displayed values to reflect your current environment.

Authentication

Local
 Domain

Domain Name:

WINS Address: . . .

PDC is on the same subnet as this server
 Specify PDC using DNS or WINS

PDC Name:

PDC Address: . . .

Cancel Help < Back Next >

PDC Is on Same Subnet

Indicates that the PDC is on the same subnet.

Specify PDC Using DNS or WINS

Select this option to use DNS or WINS to specify the primary domain controller.

PDC Name

A PDC server name and static IP address are needed if the PDC is on a different subnet. This option should be used only when there is a valid reason for overriding WINS or DNS.

PDC Address

The address of the PDC must be static; otherwise, if the PDC reboots and the address changes, the server running Novell Native File Access Protocols software will not be able to contact the PDC.

Selecting IP Addresses to Service Windows Workstations

Although we recommend that you enable the CIFS protocol on all IP addresses, you can specify which IP addresses will respond to CIFS protocol requests.

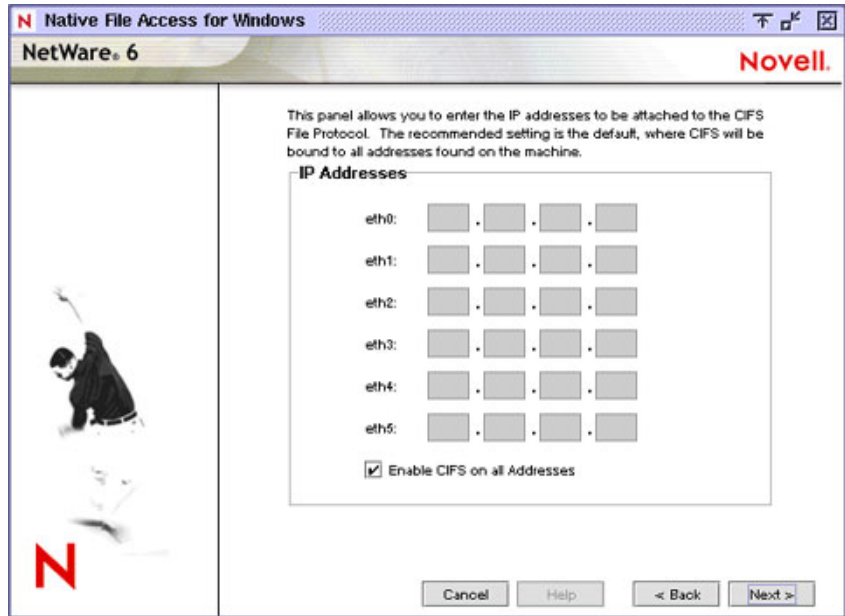

Specifying Share Points for Windows Workstations

Any volume or directory on the server can be specified as a shared point and made accessible via the Network Neighborhood or My Network Places. If no share points are specified, then all mounted volumes are displayed.

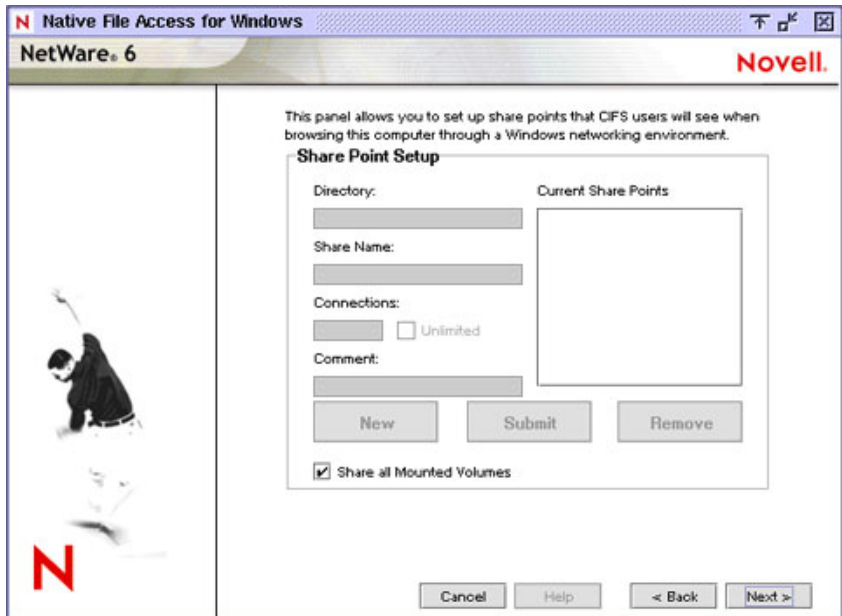

Directory

The path to the server volume or directory which becomes the root of the sharepoint. Beginning at the volume name, the full path must be specified and it must end with a backslash (\). For example:

VOL1:GRAPHICS\

Share Name

The name by which the sharepoint is displayed to Windows computers. For example, if you enter **Lots of Pics** as the sharename associated with VOL1\GRAPHICS, then Windows workstations browsing the network see "Lots of Pics" instead of "VOL1\GRAPHICS."

Connections

The number of connections allowed to access the sharepoint.

Comment

A description for the sharepoint that appears in Network Neighborhood or My Network Places.

Set Up Contexts for Windows Workstations

You must specify the NDS contexts of Windows users that require access to the network. These contexts are saved in the context search file. When the Windows user enters a username, the Novell Native File Access Protocol software searches through each context in the list until it finds the correct User object. For example if you had users with full NDS distinguished names such as Bob.sales.acme, Sue.graphics.marketing.acme, Pat.graphics.marketing, and Jo.marketing.acme, then you would enter the following contexts:

sales.acme

graphics.marketing.acme

marketing.acme

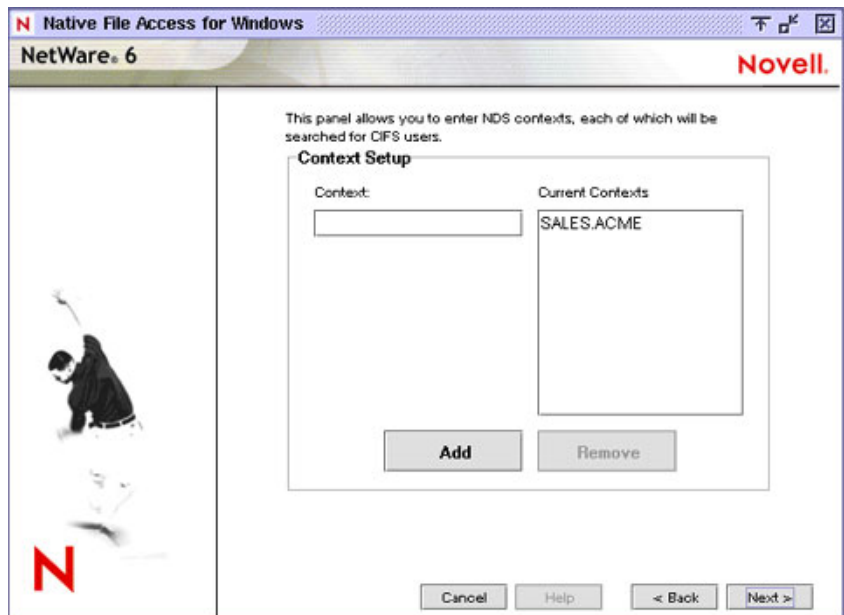

If User objects with the same name exist in different contexts, each user object attempts authentication in order until one succeeds with the corresponding password.

After server installation, you can add or remove contexts by editing the context search file (CIFSCTXS.CFG) in the SYS:\ETC directory of the server running Novell Native File Access Protocols.

Next Steps for Novell Native File Access Protocols

After completing the installation of the Novell Native File Access Protocols, you must create passwords for users before they can access the files on the server. For more information, see the *Novell Native File Access Protocols Installation and Administration Guide*.

Setting Up NetWare WebAccess

NetWare WebAccess lets administrators set up a Web page that allows users access to multiple network resources from their Web browser. Users do not need a Novell Client or VPN client to access to their resources. They can access these resources on the Web from any computer with a compliant browser.

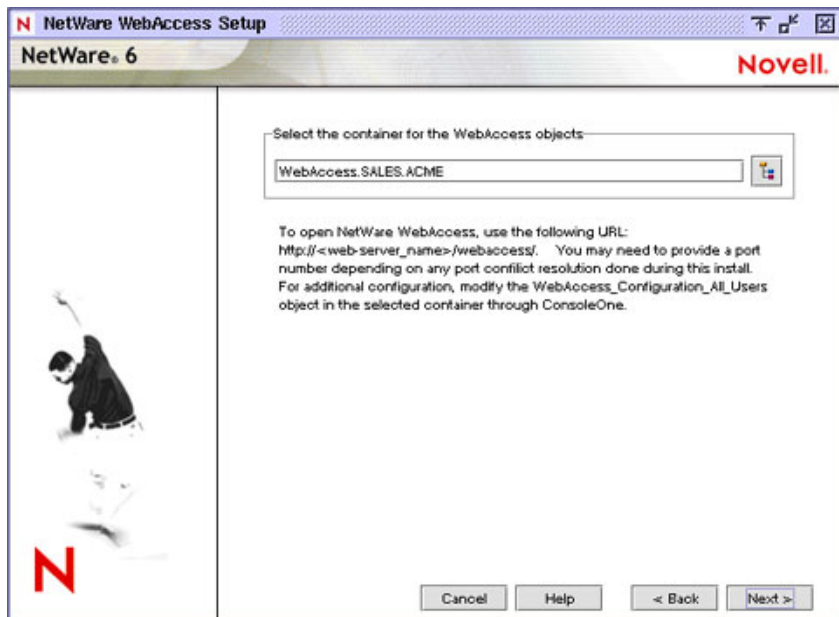

Customized content is provided through *gadgets* which provide access to specific content on the network. Gadgets communicate with the appropriate back-end system to gather the necessary data for a particular user—and users can access it all with a single password. For more information, see *NetWare WebAccess Overview and Installation*.

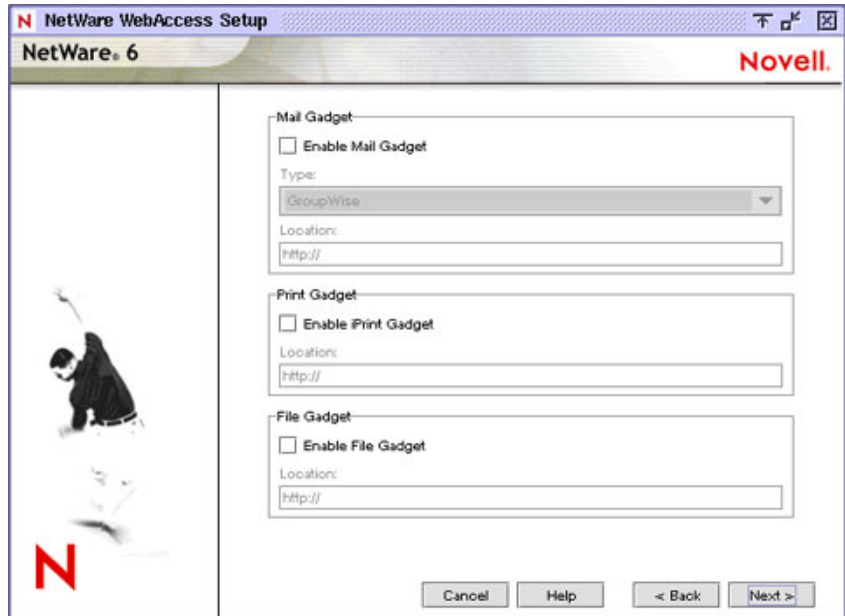

Choose which gadgets you want to enable and configure now and which gadgets you want to enable and configure later by checking or unchecking the check boxes next to each gadget type. All gadgets are installed automatically when you install NetWare WebAccess. This screen lets you choose whether to enable and configure those gadgets now or later.

The default is to enable and configure gadgets later, because during a new server installation, the applications accessed by the gadgets might not have been installed yet. If you choose to enable and configure gadgets now, you must specify the location (URL) that you want the gadgets to link to for each application.

Mail Gadget

Type

If you choose to enable and configure the Mail gadget now, you will need to specify your e-mail type. You can choose between GroupWise, Web-based E-mail, Exchange, Notes, or NIMS.

Location

Specify the URL of the Web server running the service.

- ♦ For GroupWise[®], the URL will be similar to `http://IP_address or DNS_name/servlet/webacc`. Substitute the IP address or DNS name of the Web server running GroupWise WebAccess.
- ♦ For Web-based e-mail, provide the URL you assigned either the IMAP or POP3 server when you set it up.
- ♦ For Microsoft Exchange, provide the URL for accessing your Exchange server. The URL might be an IP address like `http://192.168.0.1`.
- ♦ For Lotus* Notes*, provide the URL for accessing your Lotus Notes server. The URL might be something like `showcase2.notes.net`.
- ♦ For Novell Internet Messaging Services (NIMS), provide the URL to the NIMS server. The URL was created when you installed and configured NIMS, and might be something like `https://webmail.myrealbox.com`.

Print Gadget

If you choose to install the Print gadget now, you will need to specify the URL to your iPrint Web page. The URL might be something like `http://myserver.com/iPrint/hongkong.htm`.

NetStorage Gadget

If you choose to install the NetStorage gadget now, you will need to specify the location of your NetStorage server. The URL might be something like `http://myserver.com`. The NetStorage gadget requires the NetStorage component of NetWare 6, so you must choose to install the NetStorage component during the NetWare 6 installation.

Setting Up Novell iManager

Novell iManager runs in an Internet browser and is used for administering, managing, and configuring Novell eDirectory objects. Novell iManager gives you the ability to assign specific tasks or responsibilities to users and to present the user with only the tools (with the accompanying rights) necessary to perform those sets of tasks.

In NetWare 6, you can use Novell iManager to administer iPrint, DNS/DHCP, and Novell Licensing Services.

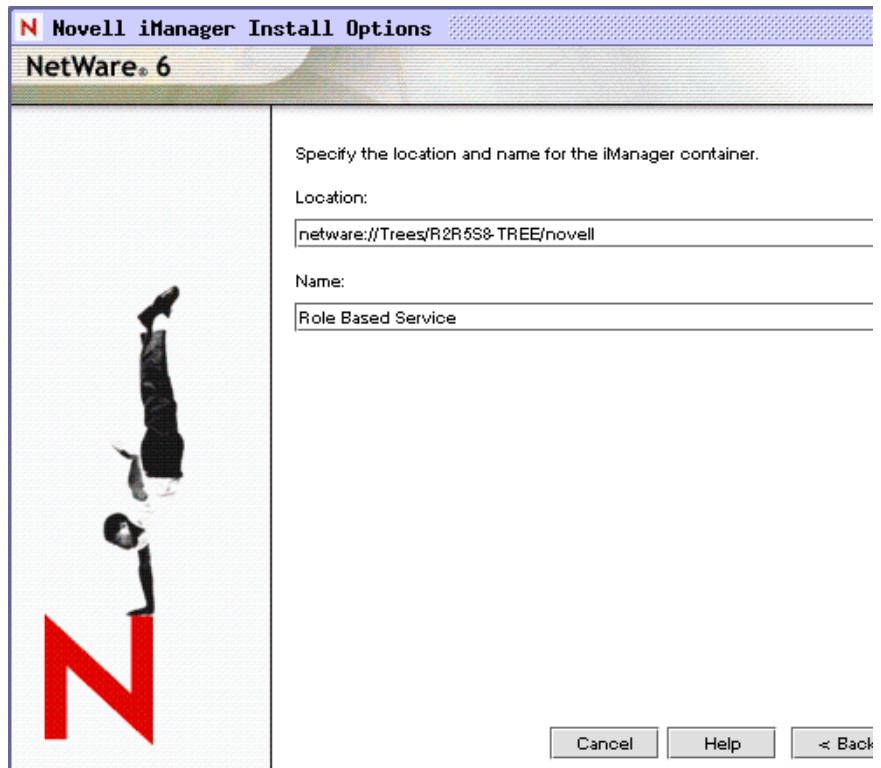

N Novell iManager Install Options

NetWare 6

Specify the location and name for the iManager container.

Location:

Name:

During installation, roles and tasks are installed and associated with the logged-in user (typically the Admin user) by default. These role and task objects are stored in a new eDirectory container (rbsCollection). You can select the location and name of the new container or use the defaults provided.

Location

Enter the path to the eDirectory container that you want to create the rbsCollection container in, or use the default location.

Name

Enter a name for the rbsCollection or use the default name.

Install Novell iFolder

Novell iFolder is a file storage and management solution to the universal problems associated with storing and retrieving data. With iFolder you have the latest version of your data when you need it and where you need it from any computer that you regularly use. And if you are not at a computer that you regularly use, you can still access and manage your files if you have an Internet connection and a Java-enabled browser. For more information, see the *Novell iFolder Administration Guide*

The screenshot shows a dialog box titled "iFolder Server Options" from NetWare 6. The dialog is divided into two panes. The left pane contains a graphic of a person in a dark jacket and light pants, captured in a dynamic pose as if performing a trick or dance move, with a large red letter "N" below it. The right pane is titled "iFolder Server Options" and contains the following fields:

- User Data:** A text box containing "SYS:\iFolder".
- Admin Name(s):** A text box containing "admin".
- Network Domain:** An empty text box.
- Administrator's Email Address:** A text box containing "admin@".

At the bottom of the dialog, there are four buttons: "Cancel", "Help", "< Back", and "Next >".

User Data

Enter the path to the directory where you want the iFolder user data to be stored on the server.

Admin Names

Enter the names of all the administrators who need rights to modify iFolder user account information via the Server Management Console. If you are entering more than one name, separate the usernames with a semicolon (;). For example, if you wanted users JSmith and Admin to have rights to administer the Server Management Console, you would enter **admin;jsmith**.

Network Domain

Enter the IP address or the DNS name of your iFolder server.

Install Novell NetStorage

Novell NetStorage provides simple Internet-based access to file storage and serves as a bridge between a company's protected Novell network and the Internet. It allows users secure file access from any Internet location, with nothing to download or install on the user's workstation. Files and folders on a Novell network can be accessed using either a browser or Microsoft Web Folders.

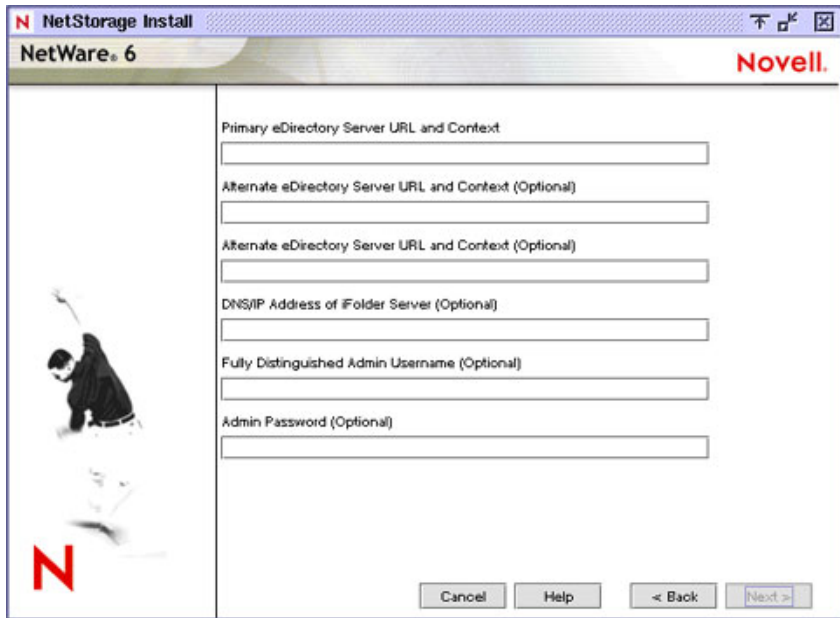

DNS Name or IP Address of Primary eDirectory Server and Context

Specify the IP address or DNS name of a server in your eDirectory tree that has the master replica or a read/write replica of eDirectory. The Primary eDirectory Server URL is required for NetStorage to function properly. This does not necessarily have to be the IP address or DNS name of the server where NetStorage is to be installed.

When a user attempts to log in, NetStorage searches the eDirectory database on the server you specify for the User object. If the User object is found, NetStorage attempts to authenticate the user to eDirectory.

If you know the eDirectory context for the users that will use NetStorage, you can add that context to the URL by inserting a colon (:) between the IP address or DNS name and the eDirectory context. The context is optional. If no context is specified, NetStorage searches the entire eDirectory tree on the primary eDirectory server for User objects. For example, if the IP address of the server is 127.0.0.1 and the eDirectory context for your users is Personnel, then you would add **127.0.0.1:personnel** to the field.

DNS Name or IP Address of Alternate eDirectory Server and Context (Optional)

This optional text box is where you specify alternate IP addresses or DNS names of other servers in your directory tree that have at least read/write eDirectory replicas. You can add two alternate eDirectory server URL and context settings.

These alternate settings can be used in the event that eDirectory authentication cannot be accomplished using the primary eDirectory server URL and context. The alternate URL and context settings are optional, but can help provide users with an additional level of access to NetStorage.

DNS Name or IP Address and Port Number of iFolder Server (Optional)

Specify the IP address or DNS name and the port number that you assigned to Novell iFolder. The iFolder DNS name or IP address and the port number are optional but, if specified, will allow NetStorage users to access and manipulate files and directories on the iFolder server.

HINT: Click Back to view the screen where the IP address and port number assignments were made.

Customizing the Installation

You can customize the installation of many products for your networking environment.

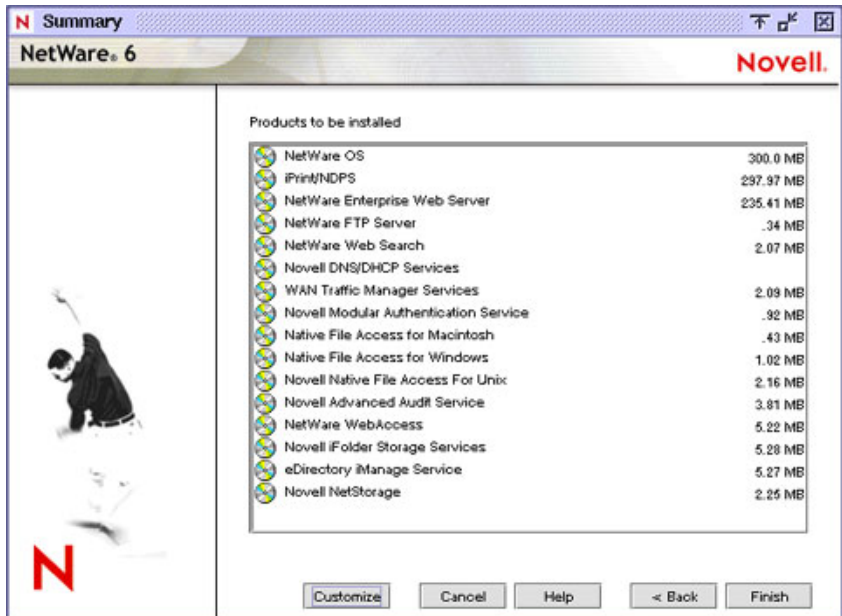

To customize products and components, at the Summary screen click Customize to access the Customize screen.

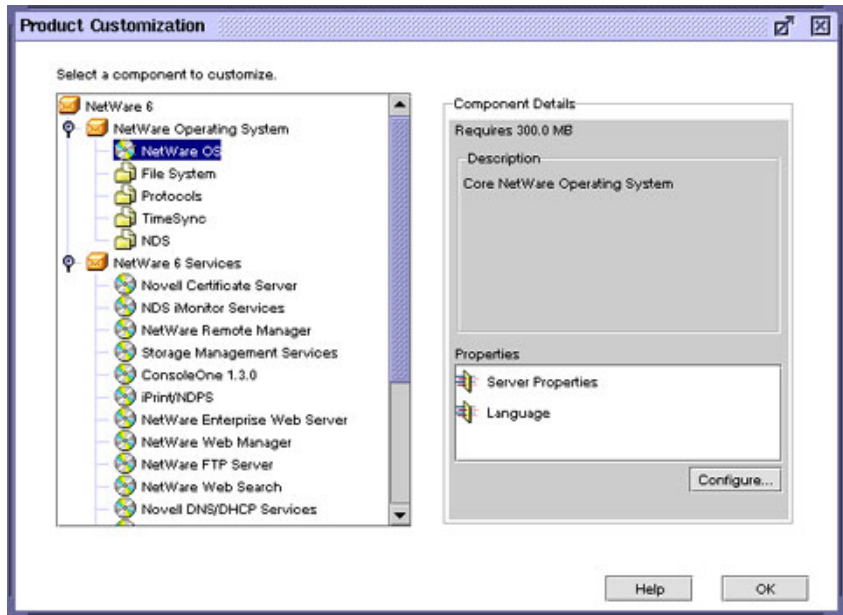

Select the product to customize. Click Properties. Modify the product as required. Click OK to return to the Summary screen.

Completing the Server Installation

The server installation program is now ready to copy files to your computer. Depending on which products you are installing, you might be prompted for additional information.

At the Summary screen, click Finish to begin copying the files to the server. After all files are copied, the server must be rebooted in order for the settings to take effect.

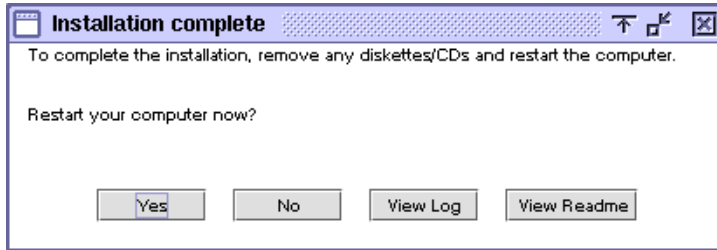

After the files are copied, click Yes to reboot the server. If you chose to load server on reboot, the NetWare 6 server software will automatically load when the computer reboots.

If you chose not to load the server on reboot, you can load it manually. To load the server manually, reboot the computer by clicking Yes. When the computer reboots, change to the startup directory containing the NetWare server files (C:\NWSERVER) and enter **SERVER**.

What's Next?

After rebooting the server, you should continue by completing the tasks described in [Chapter 4, "Installing Products and Updates,"](#) on page 103.

3

Upgrading to NetWare 6

The NetWare® 6 installation program can be used to upgrade an existing NetWare 4 or NetWare 5 server to NetWare 6.

The upgrade process includes the following tasks:

- ◆ Meet system and software requirements
- ◆ Prepare the network and the computer
- ◆ Specify hardware and software settings
- ◆ Create additional disk volumes (if required)
- ◆ Select and install networking protocols
- ◆ Set up Novell® eDirectory™
- ◆ Install other networking products

During the upgrade program, the server is upgraded to NetWare 6 by automating the following tasks:

- ◆ Device drivers and LAN drivers for the NetWare 6 operating system are loaded. Outdated drivers are matched with and replaced by new drivers included with NetWare 6.
- ◆ eDirectory is upgraded.
- ◆ NetWare 6 information is added to the AUTOEXEC.NCF and STARTUP.NCF files.
- ◆ The NetWare 6 files are copied to the server.

Meet System and Software Requirements

To upgrade to NetWare 6, your system must meet the minimum requirements listed below.

System and Software Requirements

- The server to be upgraded must be running one of the following:
 - ◆ NetWare 5.1 with Support Pack 2 or later
 - ◆ NetWare 5 with Support Pack 6 or later
 - ◆ NetWare 4.2 with Support Pack 8 or later
 - ◆ NetWare 4.11 with Support Pack 8 or later
- A server-class PC with a Pentium II or AMD K7 processor
- 256 MB of RAM
- A Super VGA display adapter
- A DOS partition of at least 100 MB with 35 MB available space
- 2 GB of available disk space on volume SYS:
- One network board
- A CD drive
- A USB, PS/2, or serial mouse (recommended but not required)

Software and Other Requirements

Depending on the network configuration, you might need one or all of the following software and information:

- NetWare 6 Operating System* CD
- NetWare 6 License/Cryptography* diskette
- Supervisor right at the [Root] of the eDirectory tree
- Supervisor right to the container where the Server object resides
- Read right to the Security container object for the eDirectory tree

- ❑ CD drivers (required to access the CD)
- ❑ Client connection utilities (optional, for upgrading from another server):
 - ◆ Novell Client™ for DOS and Windows* 3.1x (optional, for upgrading from a NetWare server running IPX™).
 - ◆ IP Server Connection Utility (optional, for installing from a NetWare server running IP only).

For instructions, see PRODUCTS\SERVERINST\IPCONN.TXT on the *Novell Client* CD.

- ❑ IP address and domain names (required for connecting to the Internet):
 - ◆ An IP address
 - ◆ An IP address of a domain name server
 - ◆ The name of your domain

For IP addresses and domain names, contact your network administrator and Internet Service Provider.

- ❑ Network board and storage device properties, such as the interrupt and port address (required if not included in NetWare).

For more information, contact your computer hardware manufacturer.

Next, you should prepare the network for the NetWare 6 server. If this server is not part of an existing network, you can skip to [“Preparing the Computer” on page 98](#).

Preparing the Network

Before you introduce a NetWare 6 server into an existing network, you must run NetWare Deployment Manager to update the network.

To update the network for NetWare 6, you must do the following:

- 1 Log in from a Windows 95/98 or Windows NT/2000 workstation to your existing network as a user with the Supervisor right.

If prompted to log into the network while using NetWare Deployment Manager, you can enter the server name or click Details and specify the IP address.

- 2 Run NetWare Deployment Manager (NWDEPLOY.EXE), located on the *NetWare 6 Operating System CD*.

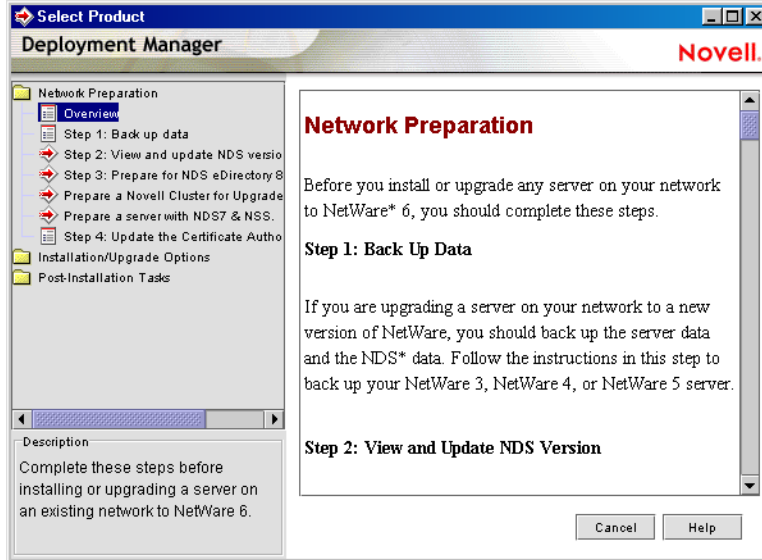

- 3 Double-click the Network Preparation folder to view the tasks and read the Overview section to get an understanding of the tasks.
- 4 Back up any server data and Novell eDirectory data following the instructions in the Back Up Data step.
- 5 Run the View and Update eDirectory Version program to update eDirectory as required.

HINT: If you are prompted to log in again while running NetWare Deployment Manager, you can enter the IP address of the server by clicking Details.

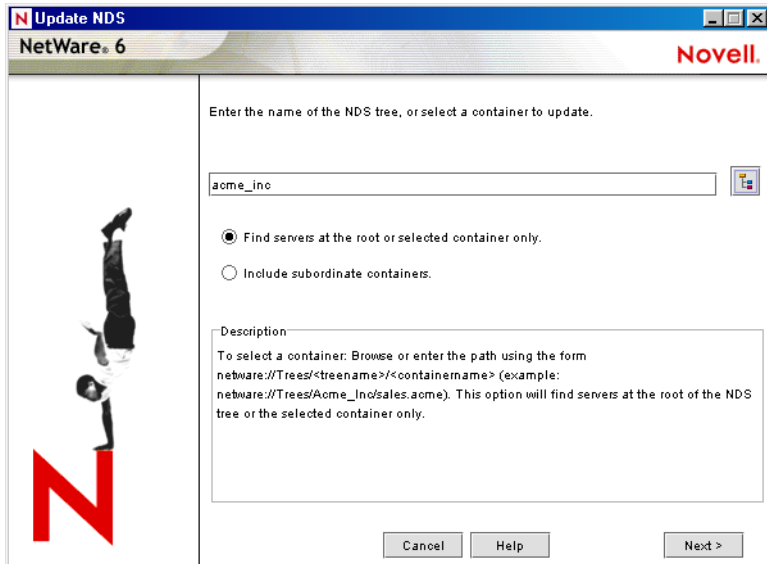

6 Run the Prepare for eDirectory program to extend the network schema.

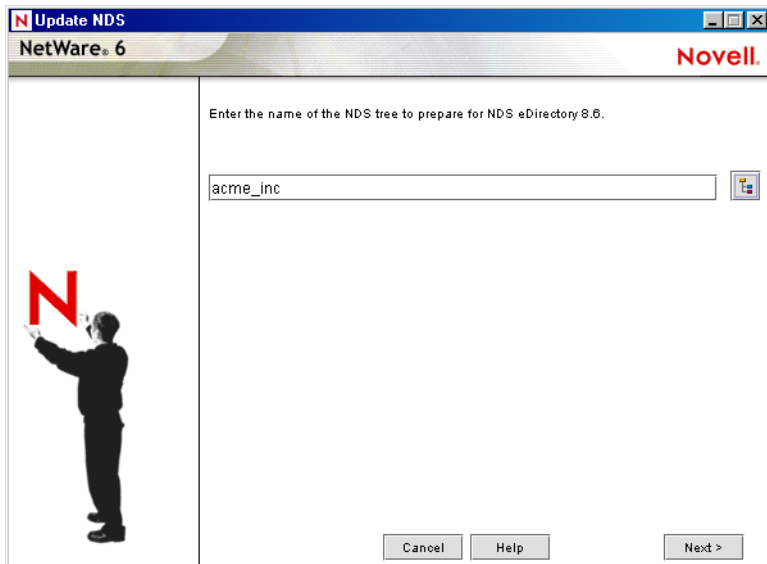

- 7 (Conditional) If you are upgrading a cluster of NetWare servers, run the Prepare a Novell Cluster for Upgrade program.
- 8 (Conditional) If you are upgrading a NetWare 5 server running NDS[®] 7 that has NSS volumes, run the Prepare a Server with NDS 7 and NSS program.
- 9 Follow the instructions in the Update Certificate Authority (CA) Object step to create or update a Security container object and a Certificate Authority (CA) object.

After you have completed the Network Preparation section of NetWare Deployment Manager, read through the Installation / Upgrade Options section to help you decide the option that best meets your needs.

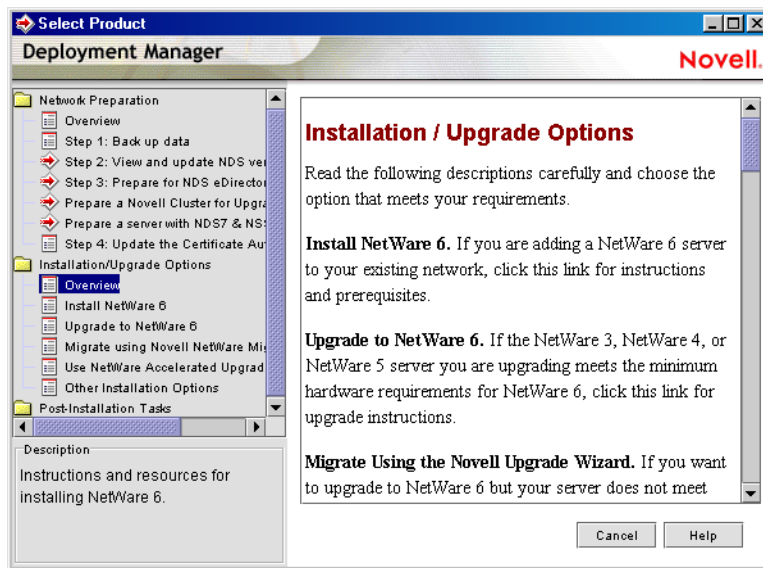

After choosing an installation or upgrade option, you should now prepare the computer to be a NetWare 6 server.

Preparing the Computer

To prepare your existing server for the NetWare 6 operating system, do the following:

- ◆ Back up the NetWare server files
- ◆ Prepare application files
- ◆ Verify a valid DOS partition
- ◆ Access the upgrade program

Backing Up the NetWare Server Files

Make at least one backup of your NetWare server files, including files on the DOS partition. Do not attempt an upgrade without a backup.

Preparing Application Files Prior to Upgrading

Some applications require that you prepare the files prior to upgrading.

Preparing IBM WebSphere Application Server for NetWare Files (Conditional)

If the server has been running IBM* WebSphere Application Server for NetWare, you must migrate your existing Web applications using the migration utility included with NetWare 6. The utility migrates WebSphere Web applications to Tomcat 3.3 Web applications.

Migrate WebSphere Applications

- 1** At the NetWare server system console, enter `XMLCONFIG -EXPORT volume_name:\websphere\migrate.xml adminNodeName NodeName`
NOTE: If you installed WebSphere to a different directory, specify that directory.
- 2** Complete the upgrade to NetWare 6.
- 3** After the upgrade, continue migrating the applications by following the instructions in "[Migrating from WebSphere to Tomcat](#)" in *Getting Results with Novell Web Services*.

Preparing Servers Running ZENworks for Server 2 (Conditional)

If the server is running ZENworks for Servers 2, you must install ZENworks for Servers 2 Support Pack 1 prior to upgrading the server to NetWare 6.

ZENworks for Servers 2 Support Pack and related information can be obtained from [Novell Technical Support \(http://support.novell.com\)](http://support.novell.com).

Verify a Valid DOS Partition

Your NetWare server uses the DOS partition to start the computer and load NetWare. Many of the existing NetWare startup files will be replaced with new NetWare 6 files. In addition, the DOS partition must exceed the minimum amount of available space to accommodate new NetWare 6 files.

If the DOS partition does not have enough available space, you cannot upgrade the server. You must create a new DOS partition and install a new server. See “[Setting Up NetWare 6](#)” on page 27.

HINT: If your computer does not meet the minimum requirements, you might try using the Novell Migration Wizard utility to migrate data to another computer. For more information, see www.novell.com/documentation.

Access the Installation Files

NetWare 6 can be upgraded from the server’s local CD drive or from installation files located on the network. To access the NetWare 6 installation files, complete the following steps.

- 1** Insert the *NetWare 6 Operating System* CD and boot the computer.
- 2** Complete one of the following:
 - ◆ If the computer boots from the CD, follow the on-screen prompts and skip to “[Selecting the Language and Accepting the License Agreement](#)” on page 36.
 - ◆ If the computer does not boot from the CD, continue with the following steps.
- 3** Boot your computer with DOS 3.3 or later.
- 4** Access the *NetWare 6 Operating System* CD.

If you install CD drivers to the disk drive, make sure that the logical filename of your CD drive (specified in the CONFIG.SYS and AUTOEXEC.BAT files) is *not* CDROM or CDINST.
- 5** Make sure that the CONFIG.SYS file contains the **FILES=100** and **BUFFERS=30** commands.

- 6 (Conditional) To upgrade from NetWare 6 files located on a network, install the Novell Client for DOS and Windows 3.1x or IP Server Connection Utility software located on the *Novell Client CD*.

What's Next

After accessing the NetWare 6 installation files, follow the instructions for installing a server beginning with [“Installing the Software” on page 35](#).

IMPORTANT: If you are upgrading a NetWare server with NSS volumes, the NSS volumes will not appear or mount until they are updated. Updating NSS volumes is done after finishing the server upgrade by following the instructions in [“Updating NSS Volumes” on page 103](#).

Because you are doing an upgrade, you are not prompted to provide all the information normally required for a new server installation. The installation program uses existing information to skip entire sections and complete the upgrade to NetWare 6.

HINT: Don't forget to select Upgrade as the type of installation.

4

Installing Products and Updates

After installing or upgrading to NetWare® 6, you should install the latest software updates and configure products to work in the new environment.

Updating NSS Volumes

If you upgraded from a NetWare 5.1 server with NSS volumes, you must complete the following procedure to update NSS volumes.

NOTE: For more detailed information, see "Updating NSS Volumes" in the *Novell Storage Services Administration Guide*.

- 1** When prompted at the end of the upgrade, reboot the computer.
- 2** Make sure that all processes relating to the NetWare 6 upgrade have completed.
- 3** At the server console, enter the following command

```
NSS /ZLSSVOLUMEUPGRADE=ALL
```

The NSS volumes can now be mounted on the NetWare 6 server.

Installing Additional Products

You should now install other networking products. For specific product information, see the product documentation in the [NetWare 6 Online Documentation](http://www.novell.com/documentation/lg/nw6p) (<http://www.novell.com/documentation/lg/nw6p>). For brief product descriptions, see [Chapter 1, "Welcome to NetWare 6," on page 11](#).

Although many products can be installed during the basic server installation, some additional products such as Novell® Cluster Services™ can be installed only after completing the server installation. You can install additional products using NetWare Deployment Manager or from the GUI server console screen.

Install Additional Products Using NetWare Deployment Manager

- 1** Log in to the network from a Windows workstation running Novell Client™ software.
- 2** Run NWDEPLOY.EXE located at the root of the *NetWare 6 Operating System* CD.
- 3** Click Post Installation Tasks > Install NetWare 6 Products.
- 4** Follow the on-screen instructions for adding the product.

HINT: Select the PRODUCT.NI file located at the root of the CD.

Install Additional Products Using the GUI Server Console Screen

- 1** Insert the *NetWare 6 Operating System* CD into the CD drive of the server.
- 2** Go to the GUI server console screen.
Start the GUI server console screen by entering **STARTX** at the server console.
- 3** Click Novell > Install > Add.
- 4** Specify the root directory of the CD and click OK.
- 5** Select the PRODUCT.NI file.
- 6** Follow the on-screen instructions for installing the product.

Installing or Updating Novell Client Software

If you are running Novell Client software, you should now upgrade your existing workstations. You can also choose to run workstations without additional software using Novell Native File Access Protocols.

For more information, see the [NetWare 6 Online Documentation \(http://www.novell.com/documentation/lg/nw6p\)](http://www.novell.com/documentation/lg/nw6p).

Installing Product Updates

For best performance, you should download and install the latest updates available at [Novell Support and Downloads \(http://support.novell.com/\)](http://support.novell.com/).

