

Driver for SAP* Business Logic Implementation Guide

Novell[®] Identity Manager

3.6.1

August 28, 2009

www.novell.com



Legal Notices

Novell, Inc., makes no representations or warranties with respect to the contents or use of this documentation, and specifically disclaims any express or implied warranties of merchantability or fitness for any particular purpose. Further, Novell, Inc., reserves the right to revise this publication and to make changes to its content, at any time, without obligation to notify any person or entity of such revisions or changes.

Further, Novell, Inc., makes no representations or warranties with respect to any software, and specifically disclaims any express or implied warranties of merchantability or fitness for any particular purpose. Further, Novell, Inc., reserves the right to make changes to any and all parts of Novell software, at any time, without any obligation to notify any person or entity of such changes.

Any products or technical information provided under this Agreement may be subject to U.S. export controls and the trade laws of other countries. You agree to comply with all export control regulations and to obtain any required licenses or classification to export, re-export or import deliverables. You agree not to export or re-export to entities on the current U.S. export exclusion lists or to any embargoed or terrorist countries as specified in the U.S. export laws. You agree to not use deliverables for prohibited nuclear, missile, or chemical biological weaponry end uses. See the [Novell International Trade Services Web page \(http://www.novell.com/info/exports/\)](http://www.novell.com/info/exports/) for more information on exporting Novell software. Novell assumes no responsibility for your failure to obtain any necessary export approvals.

Copyright © 2009 Novell, Inc. All rights reserved. No part of this publication may be reproduced, photocopied, stored on a retrieval system, or transmitted without the express written consent of the publisher.

Novell, Inc., has intellectual property rights relating to technology embodied in the product that is described in this document. In particular, and without limitation, these intellectual property rights may include one or more of the U.S. patents listed on the [Novell Legal Patents Web page \(http://www.novell.com/company/legal/patents/\)](http://www.novell.com/company/legal/patents/) and one or more additional patents or pending patent applications in the U.S. and in other countries.

Novell, Inc.
404 Wyman Street, Suite 500
Waltham, MA 02451
U.S.A.
www.novell.com

Online Documentation: To access the latest online documentation for this and other Novell products, see the [Novell Documentation Web page \(http://www.novell.com/documentation\)](http://www.novell.com/documentation).

Novell Trademarks

For Novell trademarks, see [the Novell Trademark and Service Mark list \(http://www.novell.com/company/legal/trademarks/tmlist.html\)](http://www.novell.com/company/legal/trademarks/tmlist.html).

Third-Party Materials

All third-party trademarks are the property of their respective owners.

Contents

About This Guide	7
1 Overview	9
1.1 Terminology	9
1.2 How It Works	9
1.2.1 How it Works with the SAP HR Driver	10
1.2.2 How It Works with the SAP GRC Access Control Driver	11
1.3 Driver Components	13
1.4 Support for Standard Driver Features	13
2 Installing the SAP Business Logic Driver	15
2.1 Downloading the Installation Program	15
2.2 Installing the Driver Files on the Metadirectory Engine	15
2.3 Installing the Designer and iManager Updates	16
2.3.1 Installing the 3.0.1 Designer Auto Update	16
2.3.2 Installing the Updated iManager Plug-Ins for Identity Manager	16
3 Creating a New Driver	17
3.1 Using Designer to Create and Configure the Driver	17
3.1.1 Using Designer to Import the Driver Configuration File	17
3.1.2 Using Designer to Adjust the Driver Settings	18
3.1.3 Using Designer to Deploy the Driver	18
3.1.4 Using Designer to Start the Driver	19
3.2 Using iManager to Create and Configure the Driver	19
3.2.1 Using iManager to Import the Driver Configuration File	19
3.2.2 Using iManager to Configure the Driver Settings	22
3.2.3 Using iManager to Start the Driver	22
3.3 Activating the Driver	22
4 Implementing the Driver	23
4.1 Implementing the SAP HR Driver with the SAP Business Logic Driver	23
4.1.1 Prerequisites	23
4.1.2 Linking the Drivers Together	23
4.1.3 Populating the Identity Vault with Organizational Data	24
4.1.4 Running the Job	25
4.2 Implementing the SAP GRC Access Control Driver with the SAP Business Logic Driver	26
5 Managing the Driver	27
6 Troubleshooting the Driver	29
6.1 Troubleshooting the SAP Business Logic Driver	29
6.2 Error Occurs when Uninstalling the Driver	29

A	Driver Properties	31
A.1	Driver Configuration	31
A.1.1	Driver Module	31
A.1.2	Driver Object Password (iManager Only)	32
A.1.3	Authentication	32
A.1.4	Startup Option	33
A.1.5	Driver Parameters	33
A.2	Global Configuration Values	34

About This Guide

This guide contains information about the Identity Manager driver for SAP Business Logic.

- ♦ [Chapter 1, “Overview,” on page 9](#)
- ♦ [Chapter 2, “Installing the SAP Business Logic Driver,” on page 15](#)
- ♦ [Chapter 3, “Creating a New Driver,” on page 17](#)
- ♦ [Chapter 4, “Implementing the Driver,” on page 23](#)
- ♦ [Chapter 5, “Managing the Driver,” on page 27](#)
- ♦ [Chapter 6, “Troubleshooting the Driver,” on page 29](#)
- ♦ [Appendix A, “Driver Properties,” on page 31](#)

Audience

This guide is intended for SAP integrators and Identity Manager administrators.

Feedback

We want to hear your comments and suggestions about this manual and the other documentation included with this product. Please use the User Comments feature at the bottom of each page of the online documentation, or go to www.novell.com/documentation/feedback.html and enter your comments there.

Documentation Updates

For the most recent version of the *Identity Manager Driver for SAP Business Logic Implementation Guide*, visit the [Novell® Compliance Management Platform Extension for SAP Environments Documentation Web site \(http://www.novell.com/documentation/ncmp_sap10\)](http://www.novell.com/documentation/ncmp_sap10).

Additional Documentation

For documentation on the Identity Manager Driver for SAP GRC Access Control, see the [Novell Compliance Management Platform Extension for SAP Environments Documentation Web site \(http://www.novell.com/documentation/ncmp_sap10\)](http://www.novell.com/documentation/ncmp_sap10).

For documentation on the Identity Manager Driver for SAP HR, see the [Identity Manager Driver Documentation Web site \(http://www.novell.com/documentation/idm36drivers/index.html\)](http://www.novell.com/documentation/idm36drivers/index.html).

For documentation on Identity Manager, see the [Identity Manager Documentation Web site \(http://www.novell.com/documentation/idm36/index.html\)](http://www.novell.com/documentation/idm36/index.html).

Documentation Conventions

In Novell documentation, a greater-than symbol (>) is used to separate actions within a step and items in a cross-reference path.

A trademark symbol (®, ™, etc.) denotes a Novell trademark. An asterisk (*) denotes a third-party trademark.

When a single pathname can be written with a backslash for some platforms or a forward slash for other platforms, the pathname is presented with a backslash. Users of platforms that require a forward slash, such as Linux* or UNIX*, should use forward slashes as required by your software.

Overview

1

The SAP Business Logic driver works in conjunction with the SAP HR driver and the SAP GRC Access Control driver to manage SAP data. The SAP Business Logic driver contains the logic to manage business processes. Instead of using complex policies in the SAP HR driver and the SAP GRC Access Control driver, the logic is now contained in the SAP Business Logic driver.

- ♦ [Section 1.1, “Terminology,” on page 9](#)
- ♦ [Section 1.2, “How It Works,” on page 9](#)
- ♦ [Section 1.3, “Driver Components,” on page 13](#)
- ♦ [Section 1.4, “Support for Standard Driver Features,” on page 13](#)

1.1 Terminology

This section gives you essential information about terminology used with SAP. If you need further help with SAP terminology, see the [Glossary for the SAP Library \(http://help.sap.com/saphelp_46c/helpdata/En/35/2cd77bd7705394e10000009b387c12/frameset.htm\)](http://help.sap.com/saphelp_46c/helpdata/En/35/2cd77bd7705394e10000009b387c12/frameset.htm).

ABAP: Advanced Business Application Programming. A programming language designed for creating large-scale business applications.

BAPI: Business Application Programming Interface. SAP business APIs for the SAP business object types.

CCMS: Computer Center Management System. A set of tools to monitor, control, and configure an SAP system.

CUA: Central User Administration. The SAP tool used to centrally maintain user master records.

ERP: Enterprise resource planning. A software system for planning and automating enterprise-wide business processes.

GRC: Governance, risk, and compliance. Software or business processes that facilitate conformity to legal requirements.

IDocs: Intermediate document. A data exchange format used between SAP systems and between SAP systems and external applications.

UME: User Management Engine. Provides central user administration for Java applications.

1.2 How It Works

The SAP Business Logic driver works differently with each driver it interacts with.

- ♦ [Section 1.2.1, “How it Works with the SAP HR Driver,” on page 10](#)
- ♦ [Section 1.2.2, “How It Works with the SAP GRC Access Control Driver,” on page 11](#)

1.2.1 How it Works with the SAP HR Driver

Traditionally, the SAP HR driver sends the user records through IDocs on the Publisher channel. The users are created in a container in the Identity Vault. Changes in the Identity Vault are sent to the SAP HR system through the Subscriber channel, and changes in the SAP HR system are sent through the Publisher channel. **Figure 1-1** shows how the SAP HR driver works without the SAP Business Logic driver.

Figure 1-1 SAP HR Driver with a Flat File Structure

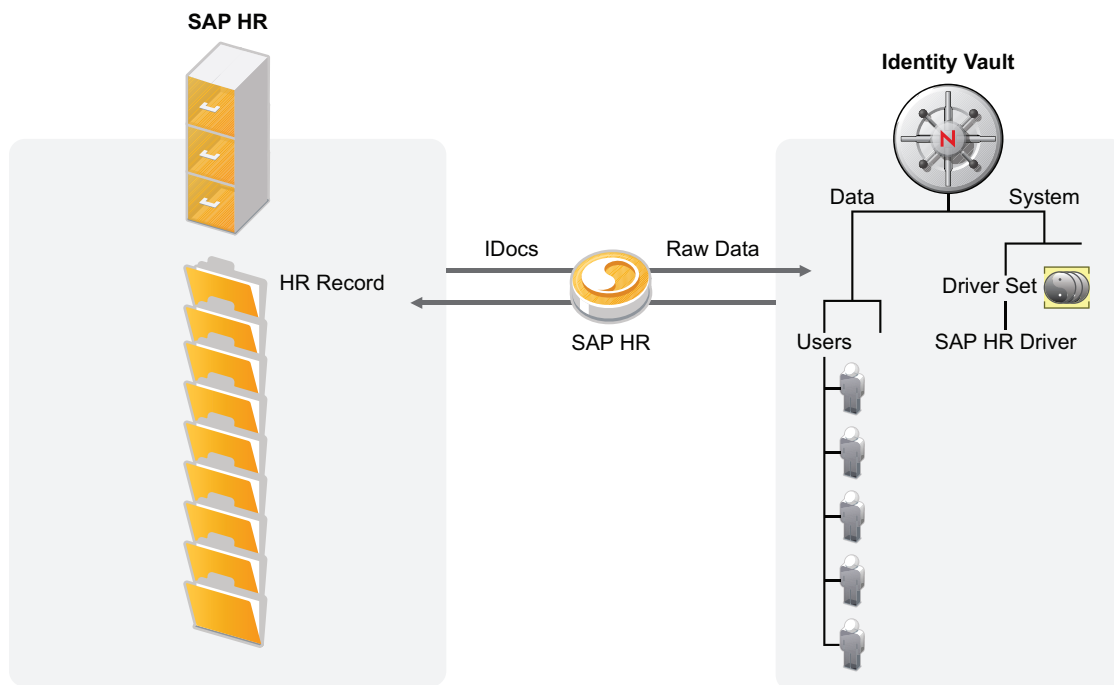

The Identity Vault can store users records in a flat structure or in an organizational structure. The SAP Business Logic driver is used in conjunction with the SAP HR driver to manage the organizational structure. **Figure 1-2** displays this structure in SAP.

The SAP HR organizational structure creates a structured hierarchy to manage SAP relationships. It also has a chief and non-chief roles, which means a user record can be connected to another record indirectly. The linking does not need to follow the child/parent relationship.

The SAP HR driver takes the raw data from the SAP HR system and synchronizes that information to the Identity Vault. The SAP Business Logic driver is linked to the SAP HR driver through a GCV on the SAP HR driver. The data is sent through the SAP Business Logic driver.

The SAP Business Logic driver receives the data from the SAP HR driver and creates the same organizational structure that exists in the SAP HR system in the Identity Vault under the SAP HR driver object.

If there are changes in the Identity Vault, that information is sent back to the SAP HR system through the SAP HR driver.

Figure 1-2 SAP Business Logic Driver with the SAP HR Driver

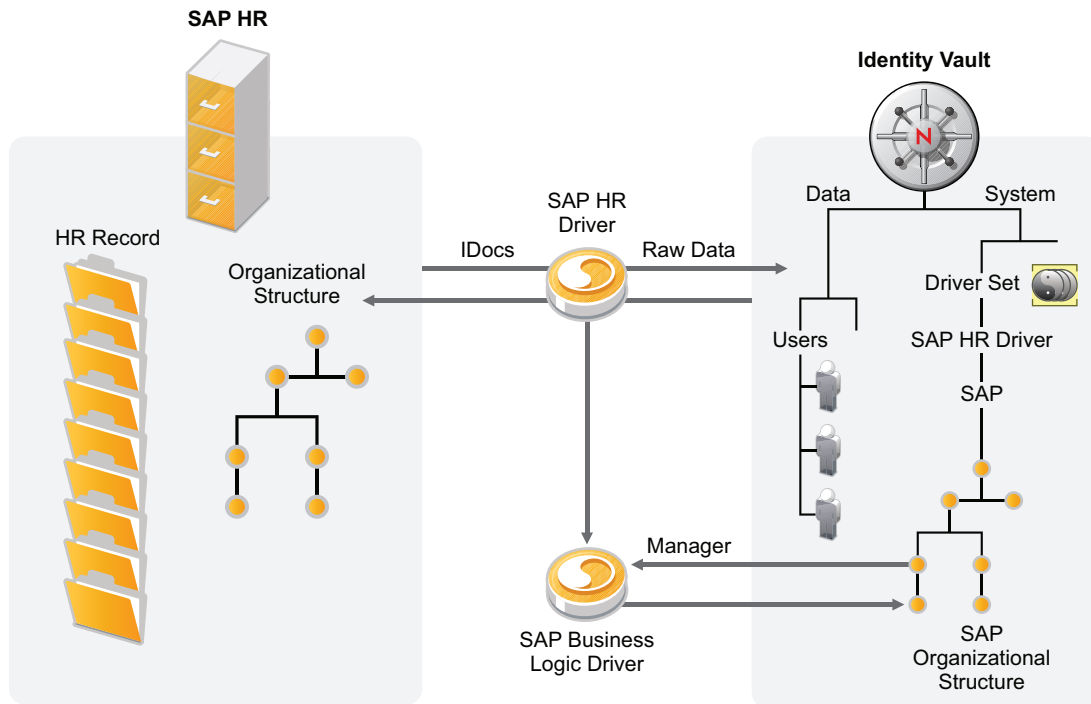

1.2.2 How It Works with the SAP GRC Access Control Driver

The GRC Access Control system is an asynchronous system, in contrast to Identity Manager which is a synchronous system. This means when a request is sent to the GRC Access Control system from the SAP GRC Access Control driver, the request can be processed immediately or it can be processed at some time in the future.

For Identity Manager to work correctly, it must know what the status of the request is. The SAP Business Logic driver is used with the SAP GRC Access Control driver to provide a way to track the status of each request. The SAP Business Logic driver acts like a timer. [Figure 1-3](#) illustrates this interaction.

Following the diagram is an explanation of how the SAP GRC Access Control driver works with the SAP Business Logic driver.

Figure 1-3 The SAP Business Logic Driver and the SAP GRC Access Control Driver

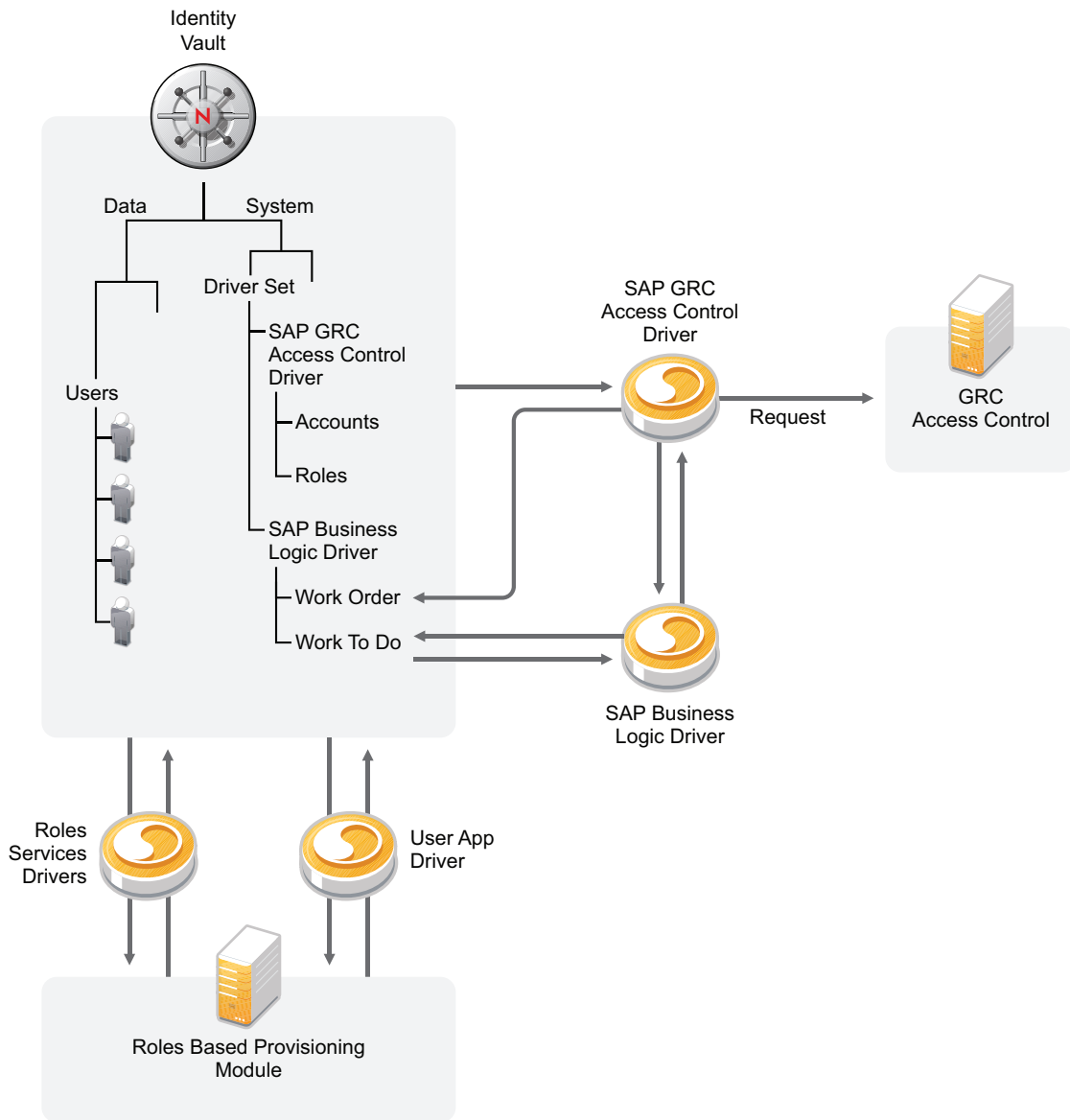

1. A role is assigned to a user in the Identity Vault through the Roles Based Provisioning Module.
2. Because the role that is assigned is associated with a GRC Access Control entitlement, the GRC Access Control entitlement is granted.
3. The GRC Access Control entitlement causes the SAP GRC Access Control driver to submit a request to the GRC Access Control system.
4. When a request is successful submitted to the GRC Access Control by the SAP GRC Access Control driver, the SAP Access Control driver creates a Work Order object.
5. The SAP Business Logic detects that the Work Order object is created, then the SAP Business Logic driver creates a Work To Do object. The Work To Do object contains the request number and the status of the request. The Work To Do object exist until the request to the GRC Access Control system is completed.

6. The SAP Business Logic driver checks the status of the request. One of three things can occur, depending upon the status of the request:
 - ♦ If the status is closed, the Work Order object remains and the GRC Access Control entitlement is updated with the results of the request.
 - ♦ If the status is rejected, the Work Order object remains and the GRC Access Control entitlement is updated with the results of the request.
 - ♦ If the status is something either than closed or rejected, the Work Order object is rescheduled.

1.3 Driver Components

The driver has two components:

- ♦ **Driver Configuration File:** The driver configuration file is used to create the driver object in the Identity Vault. The driver object contains the policies that enforce the business logic.

The driver configuration filename is `SAPBL-CMP-IDM3_6_0V1.xml`. For more information, see [Chapter 3, “Creating a New Driver,” on page 17](#).

- ♦ **Driver Shim:** Schedules the Work Order objects and Work To Do objects.

The driver shim filename is `SAPBLShim.jar`. For more information, see [Chapter 2, “Installing the SAP Business Logic Driver,” on page 15](#).

1.4 Support for Standard Driver Features

The following sections provide information about how the SAP Business Logic driver supports standard driver features:

- ♦ **Local Platforms:** The SAP Business Logic driver is supported in a local configuration. The driver is supported on the same platforms as the Metadirectory engine. For more information, see “[System Requirements](#)” in the *Identity Manager 3.6.1 Installation Guide*.
- ♦ **Remote Platforms:** The SAP Business Logic driver does not support the Remote Loader configuration. The driver can only be run locally on the same server as the Metadirectory engine.
- ♦ **Entitlements:** The SAP Business Logic driver does not contain any preconfigured entitlements.
- ♦ **Password Synchronization:** The SAP Business Logic driver does not support password synchronization.

Installing the SAP Business Logic Driver

2

The SAP Business Logic driver is installed when you install the SAP Integration module. The installation program extends the Identity Vault schema and installs the driver shim. This driver requires the latest updated driver configuration file. You must update Designer and iManager to get the updated configuration file.

- ♦ [Section 2.1, “Downloading the Installation Program,” on page 15](#)
- ♦ [Section 2.2, “Installing the Driver Files on the Metadirectory Engine,” on page 15](#)
- ♦ [Section 2.3, “Installing the Designer and iManager Updates,” on page 16](#)

2.1 Downloading the Installation Program

The SAP Business Logic driver installation program is available on the [Novell® Identity Manager 3.6.1 Integration Module for Enterprise download site \(http://download.novell.com/Download?buildid=XAwwFo5tM8A~\)](http://download.novell.com/Download?buildid=XAwwFo5tM8A~).

- 1 Click *Novell Identity Manager 3.6.1 Integration Module for Enterprise*, then click *Download*.
- 2 Click *proceed to download*, then download the `NIIdM_Drivers_for_SAP.iso` file.

2.2 Installing the Driver Files on the Metadirectory Engine

The installer checks for the installed version of Identity Manager. You must have Identity Manager 3.6.1 installed for the installer to work.

- 1 Use the correct installation program for your platform on the `NIIdM_Driver_for_SAP.iso` file.

Platform	File
Windows*	<code>sap_drivers_install.exe</code>
Linux	<code>./sap_drivers_install_linux.bin</code>
Solaris*	<code>./sap_drivers_install_solaris.bin</code>
AIX*	<code>./sap_drivers_install_aix.bin</code>

- 2 Read and accept the license agreement, then click *Next*.
- 3 Select *Drivers* and *Schema Extensions*, then click *Next*.
- 4 Specify the LDAP DN of an administrative user that has rights to extend schema.
- 5 Specify the password of the administrative user.
- 6 Review the pre-installation summary, then click *Install*.
- 7 Review installation complete message, then click *Done*.

2.3 Installing the Designer and iManager Updates

The latest driver configuration file for the SAP Business Logic driver must be installed to use the driver.

- ♦ [Section 2.3.1, “Installing the 3.0.1 Designer Auto Update,” on page 16](#)
- ♦ [Section 2.3.2, “Installing the Updated iManager Plug-Ins for Identity Manager,” on page 16](#)

2.3.1 Installing the 3.0.1 Designer Auto Update

In order to manage drivers with structured GCVs, you must install the 3.0.1 Designer Auto Update.

- 1 From the Designer 3.0.1 toolbar, select *Help > Check for Designer Updates*.
- 2 Follow the prompts to complete the installation.
- 3 Click *Yes* to restart Designer.

Designer must be restarted for the changes to take effect.

2.3.2 Installing the Updated iManager Plug-Ins for Identity Manager

In order to manage drivers with structured GCVs, you must install the updated iManager plug-ins.

- 1 Launch iManager and log in as an administrative user.
- 2 From the toolbar, click the *Configure* icon .
- 3 Click *Plug-in Installation > Available Novell Plug-in Modules*.
- 4 Select the *Identity Manager 3.6.1 FPI Plug-in for iManager 2.7*, then click *Install*.
- 5 Select *I Agree* in the license agreement, then click *OK*.
- 6 After the installation finishes, click *Close* twice.
- 7 Log out of iManager and restart Tomcat to have the changes take effect.

Creating a New Driver

3

After the SAP Business Logic driver files are installed on the server where you want to run the driver (see [Chapter 2, “Installing the SAP Business Logic Driver,” on page 15](#)), you can create the driver in the Identity Vault. You do so by importing the basic driver configuration file and then modifying the driver configuration to suit your environment. The following sections provide instructions:

- ♦ [Section 3.1, “Using Designer to Create and Configure the Driver,” on page 17](#)
- ♦ [Section 3.2, “Using iManager to Create and Configure the Driver,” on page 19](#)
- ♦ [Section 3.3, “Activating the Driver,” on page 22](#)

3.1 Using Designer to Create and Configure the Driver

The following sections provide steps for using Designer to create and configure a new SAP Business Logic driver. For information about using iManager to accomplish these tasks, see [Section 3.2, “Using iManager to Create and Configure the Driver,” on page 19](#).

- ♦ [Section 3.1.1, “Using Designer to Import the Driver Configuration File,” on page 17](#)
- ♦ [Section 3.1.2, “Using Designer to Adjust the Driver Settings,” on page 18](#)
- ♦ [Section 3.1.3, “Using Designer to Deploy the Driver,” on page 18](#)
- ♦ [Section 3.1.4, “Using Designer to Start the Driver,” on page 19](#)

3.1.1 Using Designer to Import the Driver Configuration File

Importing the SAP Business Logic driver configuration file creates the driver in the Identity Vault and adds the policies needed to make the driver operate correctly.

- 1 In Designer, open your project.
- 2 In the Modeler, right-click the driver set where you want to create the driver, then select *New > Driver* to display the Driver Configuration Wizard.
- 3 In the *Driver Configuration* list, select *SAP Business Logic*, then click *Run*.
- 4 On the Import Information Requested page, fill in the following fields:

Driver Name: Specify a name that is unique within the driver set.

Select servers: Verify the server that you are importing the driver to is the same server is selected in the prompt. The driver and the job must run on the same server.

- 5 Click *Next* to import the driver configuration.

At this point, the driver is created from the basic configuration file. To ensure that the driver works the way you want it to for your environment, you must review and modify (if necessary) the driver’s default configuration settings.

- 6 To modify the default configuration settings, click *Configure*, then continue with the next section, [Using Designer to Adjust the Driver Settings](#).

or

To skip the configuration settings at this time, click *Close*. When you are ready to configure the settings, continue with the next section, [Using Designer to Adjust the Driver Settings](#).

3.1.2 Using Designer to Adjust the Driver Settings

The information specified on the Import Information Requested page is the minimum information required to import the driver. However, the base configuration might not meet your needs, or you might need to change the configuration you created when you imported the driver.

- ♦ You might need to change whether the driver is running locally or remotely.
- ♦ You might need to change whether the driver is using entitlements.

If you need to do additional configuration for the driver, you must access the properties page of the driver. If you do not have the Driver Properties page displayed:

- 1 In Designer, open your project.
- 2 In the Modeler, right-click the driver icon  or the driver line, then select *Properties*.
This opens the properties page for the driver. Use the information in [Appendix A, “Driver Properties,” on page 31](#) to adjust the configuration.
- 3 Continue with [Section 3.1.3, “Using Designer to Deploy the Driver,” on page 18](#), to deploy the driver into the Identity Vault.

3.1.3 Using Designer to Deploy the Driver

After a driver is created in Designer, it must be deployed into the Identity Vault, because Designer is an offline tool.

- 1 In Designer, open your project.
- 2 In the Modeler, right-click the driver icon  or the driver line, then select *Live > Deploy*.
- 3 If you are authenticated to the Identity Vault, skip to [Step 5](#); otherwise, specify the following information to authenticate:

Host: Specify the IP address or DNS name of the server hosting the Identity Vault.

Username: Specify the DN of the user object used to authenticate to the Identity Vault.

Password: Specify the user’s password.

- 4 Click *OK*.
- 5 Read through the deployment summary, then click *Deploy*.
- 6 Read the successful message, then click *OK*.
- 7 Click *Define Security Equivalence* to assign rights to the driver.

The driver requires rights to objects within the Identity Vault. The Admin user object is most often used to supply these rights. However, you might want to create a DriversUser (for example) and assign security equivalence to that user. Whatever rights that the driver needs to have on the server, the DriversUser object must have the same security rights.

7a Click *Add*, then browse to and select the object with the correct rights.

7b Click *OK* twice.

- 8 Click *Exclude Administrative Roles* to exclude users that should not be synchronized.

You should exclude any administrative User objects (for example, Admin and Driver_User) from synchronization.

8a Click *Add*, then browse to and select the user object you want to exclude.

8b Click *OK*.

8c Repeat [Step 8a](#) and [Step 8b](#) for each object you want to exclude.

8d Click *OK*.

9 Click *OK*.

3.1.4 Using Designer to Start the Driver

When a driver is created, it is stopped by default. To make the driver work, you must start the driver and cause events to occur. Identity Manager is an event-driven system, so after the driver is started, it won't do anything until an event occurs.

To start the driver after the driver is deployed:

1 In Designer, open your project.

2 In the Modeler, right-click the driver icon  or the driver line, then select *Live > Start Driver*.

For information about management tasks with the driver, see [Chapter 5, "Managing the Driver,"](#) on [page 27](#).

3.2 Using iManager to Create and Configure the Driver

The following sections provide steps for using iManager to create and configure a new SAP Business Logic driver. For information about using Designer to accomplish these tasks, see [Section 3.1, "Using Designer to Create and Configure the Driver,"](#) on [page 17](#).

- ♦ [Section 3.2.1, "Using iManager to Import the Driver Configuration File,"](#) on [page 19](#)
- ♦ [Section 3.2.2, "Using iManager to Configure the Driver Settings,"](#) on [page 22](#)
- ♦ [Section 3.2.3, "Using iManager to Start the Driver,"](#) on [page 22](#)

3.2.1 Using iManager to Import the Driver Configuration File

Importing the SAP Business Logic driver configuration file creates the driver in the Identity Vault and adds the policies needed to make the driver work properly.

1 In iManager, click  to display the Identity Manager Administration page.

2 In the Administration list, click *Utilities > Import Configuration* to launch the Import Configuration Wizard.

3 Use the following information to complete the wizard and create the driver.

Prompt	Description
Where do you want to place the imported configuration?	You can add the driver to an existing driver set, or you can create a new driver set and add the driver to the new set. If you choose to create a new driver set, you are prompted to specify the name, context, and server for the driver set.
Import a configuration into this driver set	Use the default option, <i>Import a configuration from the server (.XML file)</i> . In the <i>Show</i> field, select <i>Identity Manager 3.6 configurations</i> . In the <i>Configurations</i> field, select the <code>SAPBL-CMP-IDM3_6_0-V1.xml</code> file.
Driver name	Specify a name that is unique within the driver set.
Select servers	Verify the server that you are importing the driver to is the same server is selected in the prompt. The driver and the job must run on the same server.
Define Security Equivalences	The driver requires rights to objects within the Identity Vault. The Admin user object is most often used to supply these rights. However, you might want to create a DriversUser (for example) and assign security equivalence to that user. Whatever rights that the driver needs to have on the server, the DriversUser object must have the same security rights.
Exclude Administrative Roles	You should exclude any administrative User objects (for example, Admin and DriversUser) from synchronization.

When you finish providing the information required by the wizard, a Summary page similar to the following is displayed.

Import Configuration

Summary - Current Configuration



Warning: Drivers May Require Configuration

Drivers imported from a configuration file may require additional configuration settings to be fully functional. Select the driver's link to edit its configuration settings.

The following summarizes the state of the driver as it currently exists.



[metaserver1](#) (NCP Server)



[driverset1](#) (Driver Set)



[SAP-BL](#) (Drivers May Require Configuration) (Driver)



[smp](#) (Schema Mapping Policy)



[none](#) (Input Transformation Policy)



[none](#) (Output Transformation Policy)



[Publisher](#) (Publisher)



[none](#) (Command Transformation Policy)



[pub-etp-DMMaintMigrate](#) (Event Transformation Policy)



[none](#) (Matching Policy)



[pu-cp-Veto](#) (Creation Policy)



[none](#) (Placement Policy)



[Subscriber](#) (Subscriber)

<< Back

Next >>

Cancel

Finish

At this point, the driver is created from the basic configuration file. To ensure that the driver works the way you want it to for your environment, you must review and modify (if necessary) the driver's default configuration settings.

- 4 To modify the default configuration settings, click the linked driver name, then continue with the next section, [Using iManager to Configure the Driver Settings](#).

or

To skip the configuration settings at this time, click *Finish*. When you are ready to configure the settings, continue with the next section, [Using iManager to Configure the Driver Settings](#).

WARNING: Do not click *Cancel* on the Summary page. This removes the driver from the Identity Vault and results in the loss of your work.

3.2.2 Using iManager to Configure the Driver Settings

The information specified during the creation of the driver is the minimum information required to import the driver. However, the base configuration might not meet your needs.

To configure the settings:

- 1** Make sure the Modify Object page for the SAP Business Logic driver is displayed in iManager. If it is not:
 - 1a** In iManager, click  to display the Identity Manager Administration page.
 - 1b** Click *Identity Manager Overview*.
 - 1c** Browse to and select the driver set object that contains the new SAP Business Logic driver.
 - 1d** Click the driver set name to access the Driver Set Overview page.
 - 1e** Click the upper right corner of the driver, then click *Edit properties*.
This displays the properties page of the driver.
- 2** Review the settings for the driver parameters, global configuration values, or engine control values. The configuration settings are explained in [Appendix A, “Driver Properties,” on page 31](#).
- 3** After modifying the settings, click *OK* to save the settings and close the Modify Object page.

You do not need to deploy the driver because iManager is live tool. It works directly with the Identity Vault.

3.2.3 Using iManager to Start the Driver

When a driver is created, you must start the driver. Identity Manager is an event-driven system, so after the driver is started, it processes events as they occur.

To start the driver after the additional configuration is completed:

- 1** In iManager, click  to display the Identity Manager Administration page.
- 2** Click *Identity Manager Overview*.
- 3** Browse to and select the driver object that contains the SAP Business Logic driver you want to start.
- 4** Click the driver set name to access the Driver Set Overview page.
- 5** Click the upper right corner of the driver, then click *Start driver*.

For information about management tasks with the driver, see [Chapter 5, “Managing the Driver,” on page 27](#).

3.3 Activating the Driver

The extension for SAP environments contains its own activation that you receive from the customer center. The drivers that are part of the extension for SAP environments require this new activation within 90 days of creating the driver. Otherwise, the driver stops working.

For more information on activation, refer to “[Activating Novell Identity Manager Products](#)” in the [Identity Manager 3.6.1 Installation Guide](#).

Implementing the Driver

Additional configuration is required with the SAP HR driver and the SAP GRC Access Control driver to implement the SAP Business Logic driver.

- ♦ [Section 4.1, “Implementing the SAP HR Driver with the SAP Business Logic Driver,” on page 23](#)
- ♦ [Section 4.2, “Implementing the SAP GRC Access Control Driver with the SAP Business Logic Driver,” on page 26](#)

4.1 Implementing the SAP HR Driver with the SAP Business Logic Driver

Complete the following tasks, in the order listed, to implement the SAP HR driver with the SAP Business Logic driver.

- ♦ [Section 4.1.1, “Prerequisites,” on page 23](#)
- ♦ [Section 4.1.2, “Linking the Drivers Together,” on page 23](#)
- ♦ [Section 4.1.3, “Populating the Identity Vault with Organizational Data,” on page 24](#)
- ♦ [Section 4.1.4, “Running the Job,” on page 25](#)

4.1.1 Prerequisites

- ❑ Install and create the SAP Business Logic driver. For more information, see [Chapter 2, “Installing the SAP Business Logic Driver,” on page 15](#) and [Chapter 3, “Creating a New Driver,” on page 17](#).
- ❑ Install and create the SAP HR driver. For more information, see [“Installing the Driver Files”](#) and [“Creating a New Driver”](#) in the *Identity Manager 3.6.1 Driver for SAP HR Implementation Guide*.

4.1.2 Linking the Drivers Together

The SAP HR and the SAP Business Logic drivers contain GCV parameters that link the two drivers together.

To set the GCV parameters on the SAP Business Logic driver:

- 1 Access the properties of the SAP Business Logic driver in either Designer or iManager.
- 2 Click the *GCVs* tab.
- 3 Use the following information to link the SAP Business Logic driver with your SAP HR driver:
Show SAP HR business logic settings: Select *show* to display the GCVs that link the drivers together. By default this is set to *hide*.
Enable SAP HR business logic: Select *Yes* to enable the SAP HR driver with the SAP Business Logic driver.

SAP HR Driver: Browse to and select the SAP HR driver to link to this SAP Business Logic driver.

Determine Hire Date from HR Action: Select *true* for the SAP Business Logic driver to determine the SAP Hire Date from an SAP Action.

Hire Action Identifier: (Conditional) This option is only available if the *Determine Hire Date from HR Action* GCV is set to *true*. Specify the SAP identifier for the Hire Action. By default this is 01.

Hire Action Reason: (Conditional) This option is only available if the *Determine Hire Date from HR Action* GCV is set to *true*. Specify the SAP reason that should be considered for the hire date. Leave this field empty only if the hire action identifier is used for the hire date.

Determine Termination Date from HR Action: Select true for the SAP Business Logic driver to determine the SAP Termination Date for an SAP Action.

Termination Action Identifier: (Conditional) This option is only available if the *Determine Termination Date from HR Action* is set to *true*. Specify the SAP identifier for the Termination Action. By default, this is 10.

Termination Action Reason: (Conditional) This option is only available if the *Determine Termination Date from HR Action* is set to *true*. Specify the SAP reason that should be considered for the termination date. Leave this field empty only if the termination action identifier is used for the termination date.

- 4 Click *OK* to save the changes.
- 5 Restart the SAP Business Logic driver to have these changes take effect.

To set the GCV parameters on the SAP HR driver:

- 1 Access the properties of the SAP HR driver in Designer or iManager, then click the *GCV* tab.
- 2 Use the following information to link the SAP HR driver with the SAP Business Logic driver.
Show Future Event Options: Select *show* to display the configuration parameters.
Record Future Events: Select *Yes* to record future events.
SAP Business Logic Driver: Browse to and select the SAP Business Logic driver.
Filter: Add the attributes you want to be notified when changes happen in the future. The attribute names must be in the Identity Vault name space.
- 3 Click *OK* to save the changes.
- 4 Restart the SAP HR driver to have these changes take effect.

4.1.3 Populating the Identity Vault with Organizational Data

In order to populate the Identity Vault with the organizational data, the existing data must be exported from SAP. To export your organization's hierarchical data, perform the following steps before starting the driver:





- 1 From the SAP client, enter the transaction code `PFAL`.
- 2 Insert the Object Type O for Organization objects.
- 3 Enter the organizations you want to export to the Identity Vault. You can choose to export one organization, a range of organizations, or all organizations.

If you are exporting a range of objects, access the *Parallel Processing* tab on the *HR: ALE Distribution of HR Master Data* page, then select a value of 100 or less at the *Number of Object per Process* prompt. This ensures that driver processing does not consume too much Java heap space.

- 4 Click *Execute*, then ensure that the status is set to *Passed to Port Okay*.
- 5 Repeat **Step 2** through **Step 4** for the Object Type C for Job objects.
- 6 Repeat **Step 2** through **Step 4** for the Object Type S for Position objects.
- 7 Repeat **Step 2** through **Step 4** for the Object Type P for Person objects.

4.1.4 Running the Job

The SAP Business Logic driver contains a job that must run to populate the Identity Vault correctly. You must schedule this job to run on a regular basis to make sure the data is current.

- 1 In iManager, click  to display the Identity Manager Administration page.
- 2 Open the Overview page for the SAP Business Logic driver:
 - 2a In the *Administration* list, click *Identity Manager Overview* to display the Identity Manager Overview page.
 - 2b In the *Search in* field, specify the fully distinguished name of the container where you want to start searching for driver sets, then click , or leave [root] in the field and click  to search from the root of the tree.
 You can also click  to browse for and select the container in the tree structure, or click  to select the container from a list of previously select objects.
 - 2c After the available driver sets are displayed on the Driver Sets page, click the desired driver set to display the SAP Business Logic driver.
 - 2d Click the driver to display the Driver Overview page.
- 3 Click the *Jobs* tab.

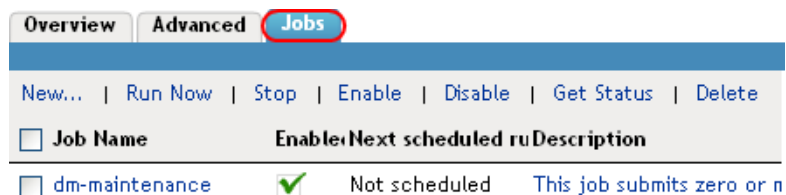

- 4 Select the dm-maintenance job, then click *Run Now* to manually run the job.
- 5 After the job runs, click the dm-maintenance job to schedule the job to run.
- 6 Click the *Schedule* tab.
- 7 Select *Run on a schedule*.
- 8 Specify a time to run the job, then select *Daily*.

The job must run daily to update the Identity Vault with the information from SAP. The job must run after SAP distributes data. For example, if SAP distributes data at 6:00 p.m., schedule the job to run at 10:00 p.m. For more information about scheduling jobs, see “**Configuring a Predefined Job’s Properties**” in the *Identity Manager 3.6 Jobs Guide*.

- 9 Click *OK* to save the changes.

4.2 Implementing the SAP GRC Access Control Driver with the SAP Business Logic Driver

The SAP GRC Access Control driver detects the SAP Business Logic driver when the SAP GRC Access Control driver is started. There is no additional configuration required to make the SAP GRC Access Control driver and the SAP Business Logic driver work together.

Make sure the SAP Business Logic driver is created and running before creating the SAP GRC Access Control driver.

Managing the Driver

5

As you work with the SAP Business Logic driver, there are a variety of management tasks you might need to perform, including the following:

- ◆ Starting, stopping, and restarting the driver
- ◆ Viewing driver version information
- ◆ Using Named Passwords to securely store passwords associated with the driver
- ◆ Monitoring the driver's health status
- ◆ Backing up the driver
- ◆ Inspecting the driver's cache files
- ◆ Viewing the driver's statistics
- ◆ Using the DirXML[®] Command Line utility to perform management tasks through scripts
- ◆ Securing the driver and its information
- ◆ Synchronizing objects
- ◆ Migrating and resynchronizing data

Because these tasks, as well as several others, are common to all Identity Manager drivers, they are included in one reference, the *Identity Manager 3.6.1 Common Driver Administration Guide*.

For additional information about securing your Identity Manager system, see the *Identity Manager 3.6 Security Guide*.

Troubleshooting the Driver

6

- [Section 6.1, “Troubleshooting the SAP Business Logic Driver,” on page 29](#)
- [Section 6.2, “Error Occurs when Uninstalling the Driver,” on page 29](#)

6.1 Troubleshooting the SAP Business Logic Driver

Viewing driver processes is necessary to analyze unexpected behavior. To view the processes, use DSTrace. You should only use DSTrace during testing and troubleshooting the driver. Running DSTrace while the drivers are in production increases the utilization on the Identity Manager server and can cause events to process very slowly. For more information, see “[Viewing Identity Manager Processes](#)” in the *Identity Manager 3.6.1 Common Driver Administration Guide*.

6.2 Error Occurs when Uninstalling the Driver

If you have installed the SAP Business Logic driver on a server that does not have a Java Virtual Machine (JVM) installed on it, you receive the following error when trying to uninstall the driver.

```
No Java virtual machine could be found from your PATH
environment variable. You must install a VM prior to
running this program.
```

The problem only occurs if you install the SAP Business Logic driver on a server that does not have Identity Manager or the Remote Loader installed on it.

The work around is to install the driver on a server with Identity Manager or the Remote Loader, or install the JVM and add the installation location to the PATH variable.

Linux/UNIX: To add the JVM to the PATH variable:

- 1 From a command line, enter `export PATH=<JAVA-HOME-PATH>/bin/:$PATH`.
- 2 Run the uninstall script for the Identity Manager drivers for SAP, where the JAVA-HOME-PATH is the Java or JRE installation location.

Windows: To add the JVM to the PATH variable, use the following command:

```
"Uninstall Novell Identity Manager Drivers for SAP.exe" LAX_VM "<JAVA-HOME-
PATH>\bin\java.exe"
```

Driver Properties

A

This section provides information about the Driver Configuration and Global Configuration Values properties for the SAP Business Logic driver. These are the only unique properties for this driver. All other driver properties (Named Password, Engine Control Values, Log Level, and so forth) are common to all drivers. Refer to “**Driver Properties**” in the *Identity Manager 3.6.1 Common Driver Administration Guide* for information about the common properties.

The information is presented from the viewpoint of iManager. If a field is different in Designer, it is marked with an  icon.

- ♦ [Section A.1, “Driver Configuration,” on page 31](#)
- ♦ [Section A.2, “Global Configuration Values,” on page 34](#)

A.1 Driver Configuration

In Designer:

- 1 Open a project in the Modeler.
- 2 Right-click the driver icon  or line, then select click *Properties > Driver Configuration*.

In iManager:

- 1 In iManager, click  to display the Identity Manager Administration page.
- 2 Open the driver set that contains the driver whose properties you want to edit:
 - 2a In the *Administration* list, click *Identity Manager Overview*.
 - 2b If the driver set is not listed on the *Driver Sets* tab, use the *Search In* field to search for and display the driver set.
 - 2c Click the driver set to open the Driver Set Overview page.
- 3 Locate the SAP Business Logic driver icon, then click the upper right corner of the driver icon to display the *Actions* menu.
- 4 Click *Edit Properties* to display the driver’s properties page.

By default, the properties page opens with the *Driver Configuration* tab displayed.

The Driver Configuration options are divided into the following sections:

- ♦ [Section A.1.1, “Driver Module,” on page 31](#)
- ♦ [Section A.1.2, “Driver Object Password \(iManager Only\),” on page 32](#)
- ♦ [Section A.1.3, “Authentication,” on page 32](#)
- ♦ [Section A.1.4, “Startup Option,” on page 33](#)
- ♦ [Section A.1.5, “Driver Parameters,” on page 33](#)

A.1.1 Driver Module

The driver module changes the driver from running locally to running remotely or the reverse. The SAP Business Logic driver is not supported in the remote configuration.

Table A-1 *Driver Modules*

Option	Description
<i>Java</i>	Used to specify the name of the Java class that is instantiated for the shim component of the driver. This class can be located in the <code>classes</code> directory as a class file, or in the <code>lib</code> directory as a <code>.jar</code> file. If this option is selected, the driver is running locally. The name of the Java class is: <code>com.novell.nds.dirxml.driver.sap.bl.SAPBLShim</code>
<i>Native</i>	This option is not used with the SAP Business Logic driver.
<i>Connect to Remote Loader</i>	Not supported with this driver.

A.1.2 Driver Object Password (iManager Only)





Table A-2 *Driver Object Password*





Option	Description
<i>Driver Object Password</i>	Not supported with this driver.

A.1.3 Authentication

The authentication options store the information required to authenticate to the connected system.

Table A-3 *Authentication Options*

Option	Description
<i>Authentication ID</i>	This field is not used for the SAP Business Logic driver.
<i>Authentication Context</i>	This field is not used for the SAP Business Logic driver.
or	
 <i>Connection Information</i>	
<i>Remote Loader Connection Parameters</i>	These fields are not used for the SAP Business Logic driver.
or	
 <i>Host name</i>	
 <i>Port</i>	
 <i>KMO</i>	
 <i>Other parameters</i>	

Option	Description
<i>Driver Cache Limit (kilobytes)</i>	Specify the maximum event cache file size (in KB). If this option is set to zero, the file size is unlimited.
or	
 <i>Cache limit (KB)</i>	 Click <i>Unlimited</i> to set the file size to unlimited in Designer.
<i>Application Password</i>	This field is not used by the SAP Business Logic driver.
or	
 <i>Set Password</i>	
<i>Remote Loader Password</i>	This field is not used by the SAP Business Logic driver.
or	
 <i>Set Password</i>	

A.1.4 Startup Option

The startup options allow you to set the driver state when the Identity Manager server is started.

Table A-4 *Startup Options*

Option	Description
<i>Auto start</i>	The driver starts every time the Identity Manager server is started.
<i>Manual</i>	The driver does not start when the Identity Manager server is started. The driver must be started through Designer or iManager.
<i>Disabled</i>	The driver has a cache file that stores all of the events. When the driver is set to Disabled, this file is deleted and no new events are stored in the file until the driver state is changed to Manual or Auto Start.
 <i>Do not automatically synchronize the driver</i>	This option only applies if the driver is deployed and was previously disabled. If this option is not selected, the driver re-synchronizes the next time it is started.

A.1.5 Driver Parameters

The driver parameters let you tune driver behavior to align with your network environment.

The parameters are presented by category:

- ◆ [Table A-5, “Driver Settings,” on page 34](#)
- ◆ [Table A-6, “Subscriber Settings,” on page 34](#)
- ◆ [Table A-7, “Publisher Settings,” on page 34](#)

Table A-5 *Driver Settings*

Parameter	Description
	There are no driver settings for the SAP Business Logic driver. NA

Table A-6 *Subscriber Settings*

Parameter	Description
	There are no Subscriber settings for the SAP Business Logic driver. NA

Table A-7 *Publisher Settings*

Parameter	Description
	There are no Publisher settings for the SAP Business Logic driver. NA

A.2 Global Configuration Values

Global configuration values (GCVs) are values that can be used by the driver to control functionality. GCVs are defined on the driver or on the driver set. Driver set GCVs can be used by all drivers in the driver set. Driver GCVs can be used only by the driver on which they are defined.

The SAP Business Logic driver includes several predefined GCVs. You can also add your own if you need additional ones as you implement policies in the driver.

To access the driver's GCVs in iManager:

- 1 Click  to display the Identity Manager Administration page.
- 2 Open the driver set that contains the driver whose properties you want to edit:
 - 2a In the *Administration* list, click *Identity Manager Overview*.
 - 2b If the driver set is not listed on the *Driver Sets* tab, use the *Search In* field to search for and display the driver set.
 - 2c Click the driver set to open the Driver Set Overview page.
 - 2d Click the GCVs page.
- 3 Modify the GCVs as necessary, using the information in [Table A-8](#).

To access the driver's GCVs in Designer:

- 1 Open a project in the Modeler.
 - 2 Right-click the driver icon  or line, then select *Properties > Global Configuration Values*.
- or

To add a GCV to the driver set, right-click the driver set icon , then click *Properties* > *GCVs*.

- 3 Modify the GCVs as necessary, using the information in [Table A-8](#).

Table A-8 *Global Configuration Values*

Option	Description
<i>Show SAP HR business logic settings</i>	Select <i>Show</i> to display the business logic configuration options for the SAP HR driver. The following options are only displayed if this option is set to <i>Show</i> .
<i>SAP HR Driver</i>	Specify the name of the SAP HR driver the SAP Business Logic driver works with.
<i>Determine Hire Date from HR Actions</i>	Select <i>True</i> to obtain the hire date from the applied HR actions.
<i>Hire Action Identifier</i>	Specify the action that is used for the hire date. Actions in SAP are defined as numbers.
<i>Hire Action Reason</i>	Specify the reason that is considered for the hire date or leave the field empty only if the action identifier is considered.
<i>Determine Termination Date from HR Actions</i>	Select <i>True</i> to obtain the termination date from the applied HR actions.
<i>Termination Action Identifier</i>	Specify the termination action that is used for the termination date. Actions in SAP are defined as numbers.
<i>Termination Action Reason</i>	Specify the reason that is considered for the termination date or leave the field empty only if the action identifier is considered.

