

Novell GroupWise® Mobile Server, Powered By Intellisync*

2

www.novell.com

GETTING STARTED GUIDE

April 16, 2008

N

Novell®

Legal Notices

Novell, Inc. makes no representations or warranties with respect to the contents or use of this documentation, and specifically disclaims any express or implied warranties of merchantability or fitness for any particular purpose. Further, Novell, Inc. reserves the right to revise this publication and to make changes to its content, at any time, without obligation to notify any person or entity of such revisions or changes.

Further, Novell, Inc. makes no representations or warranties with respect to any software, and specifically disclaims any express or implied warranties of merchantability or fitness for any particular purpose. Further, Novell, Inc. reserves the right to make changes to any and all parts of Novell software, at any time, without any obligation to notify any person or entity of such changes.

Any products or technical information provided under this Agreement may be subject to U.S. export controls and the trade laws of other countries. You agree to comply with all export control regulations and to obtain any required licenses or classification to export, re-export, or import deliverables. You agree not to export or re-export to entities on the current U.S. export exclusion lists or to any embargoed or terrorist countries as specified in the U.S. export laws. You agree to not use deliverables for prohibited nuclear, missile, or chemical biological weaponry end uses. See the [Novell International Trade Services Web page \(http://www.novell.com/info/exports/\)](http://www.novell.com/info/exports/) for more information on exporting Novell software. Novell assumes no responsibility for your failure to obtain any necessary export approvals.

Copyright © 2007-2008 Novell, Inc. All rights reserved. No part of this publication may be reproduced, photocopied, stored on a retrieval system, or transmitted without the express written consent of the publisher.

Novell, Inc. has intellectual property rights relating to technology embodied in the product that is described in this document. In particular, and without limitation, these intellectual property rights may include one or more of the U.S. patents listed on the [Novell Legal Patents Web page \(http://www.novell.com/company/legal/patents/\)](http://www.novell.com/company/legal/patents/) and one or more additional patents or pending patent applications in the U.S. and in other countries.

Novell, Inc.
404 Wyman Street, Suite 500
Waltham, MA 02451
U.S.A.
www.novell.com

Online Documentation: To access the online documentation for this and other Novell products, and to get updates, see the [Novell Documentation Web site \(http://www.novell.com/documentation\)](http://www.novell.com/documentation).

Novell Trademarks

For Novell trademarks, see [the Novell Trademark and Service Mark list \(http://www.novell.com/company/legal/trademarks/tmlist.html\)](http://www.novell.com/company/legal/trademarks/tmlist.html).

Third-Party Materials

All third-party trademarks are the property of their respective owners.

Contents

About This Guide	7
1 Overview	9
1.1 GroupWise PIM Data	9
1.2 Supported Mobile Devices	9
1.3 Nokia Intellisync Modules Included in GroupWise Mobile Server	10
1.4 Nokia Intellisync Modules Not Included in GroupWise Mobile Server	10
1.5 Operating System Support	10
1.6 GroupWise Version Support	10
1.7 Documentation Support	11
1.8 Product Features Specific to GroupWise	11
1.9 Network Configuration	11
1.9.1 Network Configuration without the Secure Gateway	11
1.9.2 Network Configuration with the Secure Gateway in Your DMZ	12
1.10 Cluster Configuration	13
1.11 Licensing	13
2 Preparing Your GroupWise System for GroupWise Mobile Server	15
2.1 Gathering GroupWise Information	15
2.2 Enabling POAs for SOAP	15
2.3 Selecting a Test User and POA	16
2.4 Using Distribution Lists for Address Book Synchronization	17
2.5 Configuring the Internet Agent to Support SMS Push	17
2.6 Adding GroupWise Mobile Server to Your GroupWise System	18
3 Installing GroupWise Mobile Server for Linux	19
3.1 Installing GroupWise Mobile Server for Linux	19
3.2 Starting and Stopping GroupWise Mobile Server on Linux	21
3.2.1 Checking the Status of GroupWise Mobile Server	22
3.2.2 Starting GroupWise Mobile Server	22
3.2.3 Stopping GroupWise Mobile Server	22
3.3 Using the GroupWise Mobile Server WebAdmin Console	22
3.4 Adding a GroupWise Authentication Source	23
3.5 Adding and Configuring a GroupWise Server	24
3.5.1 Providing Server Information	24
3.5.2 Configuring GroupWise Mobile Server Access to GroupWise	25
3.5.3 Configuring User Options	26
3.5.4 Configuring GroupWise Address Book Synchronization	26
3.5.5 Creating Multiple Profiles	28
3.6 Completing the GroupWise Mobile Server Installation	29
3.7 Enabling Web PIM Access	29
3.8 Performing Optional Configuration Tasks	30
3.8.1 Creating a Trusted Application on Linux	30
3.8.2 Changing the WebAdmin Password	31
3.8.3 Installing the Secure Gateway on Additional Linux Servers	31
3.8.4 Running Apache on the Same Server with the Secure Gateway	33

3.8.5	Configuring SMTP Relay for SMS Push	35
3.9	Updating GroupWise Mobile Server for Linux	36
3.10	Upgrading an Evaluation License on Linux	36
4	Installing GroupWise Mobile Server for Windows	39
4.1	Installing GroupWise Mobile Server for Windows	39
4.2	Starting and Stopping GroupWise Mobile Server on Windows	43
4.3	Using the Admin Console	43
4.4	Configuring a GroupWise Server	44
4.4.1	Viewing Initial Configuration Information	44
4.4.2	Configuring User Options	45
4.4.3	Configuring GroupWise Address Book Synchronization	45
4.4.4	Creating Multiple Profiles	46
4.5	Completing the GroupWise Mobile Server Installation	48
4.6	Enabling Web PIM Access	48
4.7	Performing Optional Configuration Tasks	49
4.7.1	Creating a Trusted Application on Windows	49
4.7.2	Accessing the WebAdmin Console from Your Web Browser	50
4.7.3	Reconfiguring the Secure Gateway to Use a Different Port Number	51
4.7.4	Configuring SMTP Relay for SMS Push	53
4.8	Updating GroupWise Mobile Server for Windows	54
4.9	Upgrading an Evaluation License on Windows	54
5	Initial Testing for GroupWise Mobile Server	57
5.1	Web Site Availability Test	57
5.1.1	Without a Secure Gateway	57
5.1.2	With a Secure Gateway	57
5.2	GroupWise Login Test	58
5.2.1	Logging In to GroupWise	58
5.2.2	Successful Login	58
5.2.3	Unsuccessful Login	59
6	Installing the Client Software and Configuring Device Synchronization	61
6.1	Starting the Web PIM for the First Time	61
6.2	Installing the Client Software from the GroupWise Mobile Server URL	62
6.3	Using the Web PIM to Configure Device Synchronization Settings	62
6.4	Manuals and References for the Client Software	64

About This Guide

This Novell® *GroupWise® Mobile Server 2 Getting Started Guide* helps you to understand and install GroupWise Mobile Server. The guide is divided into the following sections:

- ♦ Chapter 1, “Overview,” on page 9
- ♦ Chapter 2, “Preparing Your GroupWise System for GroupWise Mobile Server,” on page 15
- ♦ Chapter 3, “Installing GroupWise Mobile Server for Linux,” on page 19
- ♦ Chapter 4, “Installing GroupWise Mobile Server for Windows,” on page 39
- ♦ Chapter 5, “Initial Testing for GroupWise Mobile Server,” on page 57
- ♦ Chapter 6, “Installing the Client Software and Configuring Device Synchronization,” on page 61

Audience

This guide is intended for network administrators who install and administer GroupWise Mobile Server.

Feedback

We want to hear your comments and suggestions about this manual and the other documentation included with this product. Please use the User Comment feature at the bottom of each page of the online documentation, or go to www.novell.com/documentation/feedback.html and enter your comments there.

Documentation Updates

For the most recent version of the *GroupWise Mobile Server 2 Getting Started Guide*, visit the [Novell GroupWise Mobility Documentation Web site \(http://www.novell.com/documentation/gwmobility\)](http://www.novell.com/documentation/gwmobility).

Additional Documentation

For additional documentation, see the following guides provided by Nokia at the [GroupWise Mobility Documentation Web site \(http://www.novell.com/documentation/gwmobility\)](http://www.novell.com/documentation/gwmobility):

- ♦ *Intellisync Mobile Server Release Notes*
- ♦ *Intellisync Mobile Server Installation Checklists*
- ♦ *Intellisync Mobile Suite Installation Guide*
- ♦ *Intellisync Mobile Suite Linux Installation Guide*
- ♦ *Intellisync Mobile Suite Administration Guide*
- ♦ *Intellisync Mobile Suite Linux Installation Guide*
- ♦ *Intellisync Mobile Suite Windows to Linux Server Migration Guide*
- ♦ *Intellisync Mobile Suite Secure Gateway Administration Guide*
- ♦ *Client Guides* for specific mobile devices

Documentation Conventions

In Novell documentation, a greater-than symbol (>) is used to separate actions within a step and items in a cross-reference path.

A trademark symbol (® , ™ , etc.) denotes a Novell trademark. An asterisk (*) denotes a third-party trademark.

When a single pathname can be written with a backslash for some platforms or a forward slash for other platforms, the pathname is presented with a backslash. Users of platforms that require a forward slash, such as Linux*, should use forward slashes as required by your software.

When a startup switch can be written with a forward slash for some platforms or a double hyphen for other platforms, the startup switch is presented with a forward slash. Users of platforms that require a double hyphen, such as Linux, should use double hyphens as required by your software.

Overview

1

Using GroupWise® Mobile Server, you can synchronize Personal Information Manager (PIM) data from your Novell® GroupWise mailbox to your mobile device. GroupWise Mobile Server is provided to Novell by Nokia* specifically for use with GroupWise.

- ◆ Section 1.1, “GroupWise PIM Data,” on page 9
- ◆ Section 1.2, “Supported Mobile Devices,” on page 9
- ◆ Section 1.3, “Nokia Intellisync Modules Included in GroupWise Mobile Server,” on page 10
- ◆ Section 1.4, “Nokia Intellisync Modules Not Included in GroupWise Mobile Server,” on page 10
- ◆ Section 1.5, “Operating System Support,” on page 10
- ◆ Section 1.6, “GroupWise Version Support,” on page 10
- ◆ Section 1.7, “Documentation Support,” on page 11
- ◆ Section 1.8, “Product Features Specific to GroupWise,” on page 11
- ◆ Section 1.9, “Network Configuration,” on page 11
- ◆ Section 1.10, “Cluster Configuration,” on page 13
- ◆ Section 1.11, “Licensing,” on page 13

1.1 GroupWise PIM Data

GroupWise PIM data includes:

- ◆ E-mail messages and folders
- ◆ Address books and contacts
- ◆ Appointments and other significant calendar dates
- ◆ Tasks and task lists
- ◆ Reminders and alarms

1.2 Supported Mobile Devices

Devices supported by GroupWise Mobile Server include:

- ◆ Windows* CE devices
- ◆ Windows Mobile*-based Smartphones
- ◆ Symbian* OS devices
- ◆ Palm OS* devices
- ◆ SyncML* devices
- ◆ BREW* devices (supported for GroupWise Mobile Server but not for Intellisync Mobile Suite)

To view the current, complete list of supported mobile devices, see the *Intellisync Mobile Suite Release Notes* (<http://www.novell.com/documentation/gwmobility>).

1.3 Nokia Intellisync Modules Included in GroupWise Mobile Server

GroupWise Mobile Server includes the following modules from the Nokia Intellisync Mobile Suite:

- ♦ Intellisync Wireless Email with the GroupWise Connector
- ♦ Intellisync Mobile Gateway
- ♦ Intellisync Secure Gateway
- ♦ Synchronization software for supported mobile devices

1.4 Nokia Intellisync Modules Not Included in GroupWise Mobile Server

GroupWise Mobile Server *does not* include the following modules of the Nokia Intellisync Mobile Suite:

- ♦ Certain components of Intellisync Wireless Email: Microsoft* Exchange Connector, Lotus Notes* Connector, POP3, IMAP, Workgroup, and PC Monitor
- ♦ Intellisync Device Management
- ♦ Intellisync File Sync
- ♦ Intellisync Application Sync

When you use the guides provided by Nokia, keep in mind that they include components and modules that are not available in GroupWise Mobile Server, as listed above. These modules can be purchased separately from [Nokia \(http://www.nokia.com\)](http://www.nokia.com).

1.5 Operating System Support

GroupWise Mobile Server is available on the following operating systems:

- ♦ SUSE® Linux Enterprise Server
- ♦ Windows Server

For more detailed platform information, see the *Intellisync Mobile Suite Installation Guide* (<http://www.novell.com/documentation/gwmobility>) for your platform version of GroupWise Mobile Server.

You must run all Intellisync Mobile Suite modules on the same platform. For example, you cannot install Wireless Email for GroupWise on Linux and the Secure Gateway on Windows, or vice versa.

NOTE: Unlike GroupWise, GroupWise Mobile Server is not available on Novell Open Enterprise Server Linux or NetWare®.

1.6 GroupWise Version Support

GroupWise 7 Support Pack 1 or later is required. GroupWise Mobile Server is not compatible with earlier versions of GroupWise.

1.7 Documentation Support

The documentation set for GroupWise Mobile Server includes documentation from Novell and documentation from Nokia.

This *Getting Started Guide* provided by Novell focuses on information specific to GroupWise.

The guides provided by Nokia, as listed in “[About This Guide](#)” on page 7, include some information that does not pertain to GroupWise Mobile Server. When using the Nokia guides, make sure that the sections you are using do pertain to GroupWise Mobile Server. The Nokia guides refer to documentation available in the \Documentation directory of the installation source folder when you install on Windows and to documentation available on the [Nokia Support Web site \(http://support.nokia.com\)](http://support.nokia.com) when you install on Linux. However, all the Novell and Nokia documentation that you need for GroupWise Mobile Server is found on the [GroupWise Mobility Documentation Web site \(http://www.novell.com/documentation/gwmobility\)](http://www.novell.com/documentation/gwmobility).

1.8 Product Features Specific to GroupWise

In addition to the product features described in the Nokia guides, GroupWise Mobile Server provides the following features to benefit GroupWise users:

- ♦ Synchronizing the contents of your GroupWise mailbox to your supported mobile device.
- ♦ Using the Push feature, so that your device receives new GroupWise items as they arrive in your GroupWise mailbox, without any intervention from you.
- ♦ Connecting to multiple POAs throughout your GroupWise system to distribute the synchronization load.
- ♦ Always connecting users to their own post offices when synchronizing, in order to minimize network traffic.

1.9 Network Configuration

Your company policy might dictate how you deploy GroupWise Mobile Server within your network configuration. Several configuration options are available. Novell supports either of the following configurations:

- ♦ If your company does not have a demilitarized zone (DMZ) or a screened subnet, you can install GroupWise Mobile Server as a standalone system.
- ♦ If your company uses a DMZ or a screened subnet, you should use the Secure Gateway between your DMZ or screened subnet and your GroupWise Mobile Server machine.

Follow the configuration instructions for your environment:

- ♦ [Section 1.9.1, “Network Configuration without the Secure Gateway,” on page 11](#)
- ♦ [Section 1.9.2, “Network Configuration with the Secure Gateway in Your DMZ,” on page 12](#)

1.9.1 Network Configuration without the Secure Gateway

If you choose to install GroupWise Mobile Server without the Secure Gateway, communication between devices and GroupWise Mobile Server is a direct connection.

The following illustration depicts a typical network configuration without the Secure Gateway:

Figure 1-1 Network Configuration without the Secure Gateway

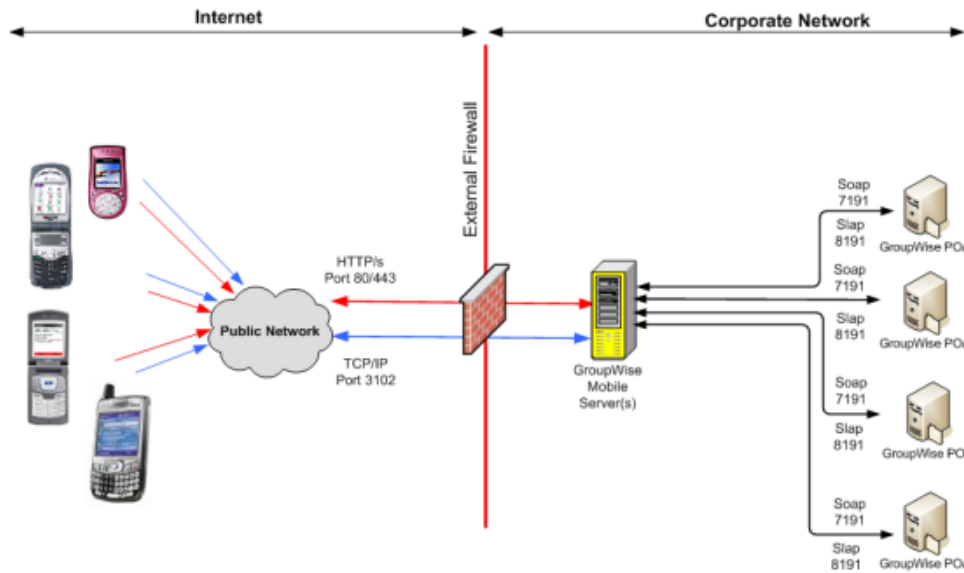

1.9.2 Network Configuration with the Secure Gateway in Your DMZ

Novell recommends using the Secure Gateway configuration within your network. The Secure Gateway offers secure and scalable communications between mobile devices and servers. It consists of an HTTP listener and communications services.

The Secure Gateway intercepts the HTTP requests from mobile devices to the GroupWise Mobile Server machine and can route the requests in three ways:

- ◆ Synchronization requests through ports 80 (non-secure HTTP) and 443 (secure HTTPS)
- ◆ Web requests through ports 80 (non-secure HTTP) and 443 (secure HTTPS)
- ◆ Push requests through TCP/IP port 3102

Figure 1-2 Network Configuration with the Secure Gateway

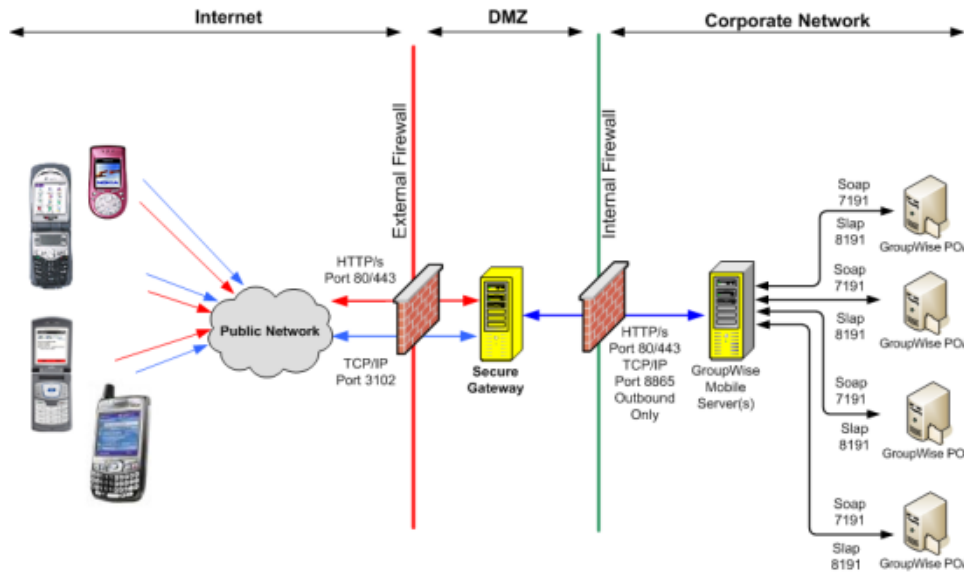

Port 8865 must be open through your internal firewall so that GroupWise Mobile Server can receive Push notifications from the POA.

For information on how to install and configure the Secure Gateway, see the *Intellisync Mobile Suite Secure Gateway Administrator's Guide* on the [GroupWise Mobility Web site \(http://www.novell.com/documentation/gwmobility\)](http://www.novell.com/documentation/gwmobility).

1.10 Cluster Configuration

If GroupWise Mobile Server must communicate with POAs that run in a cluster, the POAs must be configured with the secondary IP address of each POA cluster resource, not the primary IP address of any specific node in the cluster.

1.11 Licensing

GroupWise Mobile Server is available for evaluation as a free download from the [Novell Downloads Web site \(http://download.novell.com\)](http://download.novell.com). The evaluation license allows you to use GroupWise Mobile Server (either the Linux or the Windows version, or both) for 90 days. The evaluation license allows you to have the same number of users as allowed by your GroupWise license. Contact Novell to upgrade an evaluation license or add more client users to an existing license. In order to qualify for permanent GroupWise Mobile Server licenses, you must be current on your Maintenance or Upgrade Protection for GroupWise 7 or later.

To upgrade from evaluation to permanent licenses, follow the instructions for your platform version of GroupWise Mobile Server:

- ◆ [Section 3.10, "Upgrading an Evaluation License on Linux," on page 36](#)
- ◆ [Section 4.9, "Upgrading an Evaluation License on Windows," on page 54](#)

Preparing Your GroupWise System for GroupWise Mobile Server

2

GroupWise[®] Mobile Server uses the SOAP protocol to communicate with GroupWise Post Office Agents (POAs). Before you install GroupWise Mobile Server, you must enable SOAP on the POAs of all post offices that have mobile device users. You also need to select a GroupWise username and password to test the connection between GroupWise Mobile Server and your GroupWise system.

- ♦ [Section 2.1, “Gathering GroupWise Information,” on page 15](#)
- ♦ [Section 2.2, “Enabling POAs for SOAP,” on page 15](#)
- ♦ [Section 2.3, “Selecting a Test User and POA,” on page 16](#)
- ♦ [Section 2.4, “Using Distribution Lists for Address Book Synchronization,” on page 17](#)
- ♦ [Section 2.5, “Configuring the Internet Agent to Support SMS Push,” on page 17](#)
- ♦ [Section 2.6, “Adding GroupWise Mobile Server to Your GroupWise System,” on page 18](#)

2.1 Gathering GroupWise Information

- 1 Print and fill out the *Server Installation Checklist* (<http://www.novell.com/documentation/gwmobility>).
- 2 Print and fill out the *Wireless Email Installation Checklist for GroupWise* (<http://www.novell.com/documentation/gwmobility>).

NOTE: At present, the checklists cover installing on Windows, but most of the same information still needs to be gathered for Linux. If you are installing on Linux, simply skip the Windows-specific parts of the checklists.

The following sections assist you with gathering some of the required information.

2.2 Enabling POAs for SOAP

- 1 In ConsoleOne[®], browse to and right-click a POA object, then click *Properties*.
- 2 Click *GroupWise > Agent Settings*.

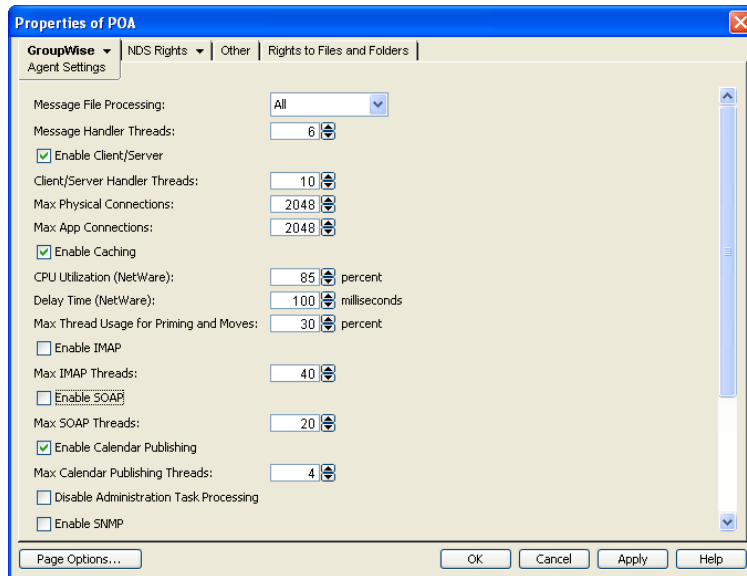

- 3 Select *Enable SOAP*, then click *OK*.

The default of 20 SOAP threads is typically appropriate. You can lower the number of SOAP threads so that the POA's communication with GroupWise Mobile Server takes fewer POA resources, but you cannot increase the number of SOAP threads above 20.

- 4 Repeat **Step 1** through **Step 3** for each POA that services a post office where mobile device users have mailboxes.

2.3 Selecting a Test User and POA

When you install GroupWise Mobile Server, you need to specify a GroupWise user and the POA that services that user's mailbox in order to test the connection between GroupWise Mobile Server and your GroupWise system.

- 1 In ConsoleOne, select the GroupWise System object.
- 2 In the drop-down list, select *Users*.
- 3 Choose a user for testing the connection between GroupWise Mobile Server and your GroupWise system.
- 4 Make a note of the username and the post office to which the user belongs.
- 5 In the drop-down list, select *Post Office Agents*.
- 6 Right-click the POA object for the post office to which the user belongs, then click *Properties*.
- 7 Click *GroupWise > Network Address*.

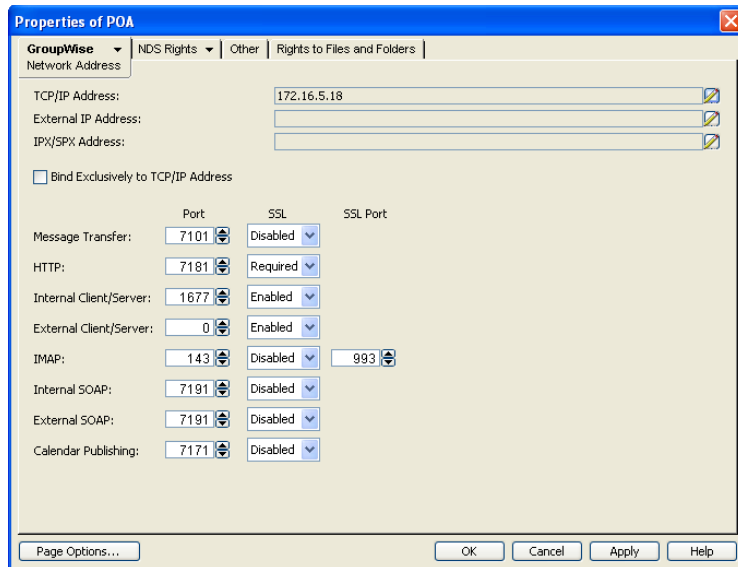

- 8 Make a note of the IP address or DNS hostname of the server where the POA runs.
- 9 Make a note of the internal SOAP port number for the POA.
- 10 If you want to use a secure SSL connection between GroupWise Mobile Server and the POA, select *Required* in the *SSL* column of the *Internal SOAP* field.
If you enable SSL for the POA, follow the instructions in “[Securing the Post Office with SSL Connections to the POA](#)” in “[Post Office Agent](#)” in the *GroupWise 7 Administration Guide*.
- 11 Click *OK* to close the Properties page.

2.4 Using Distribution Lists for Address Book Synchronization

If your GroupWise Address Book is too large to synchronize to mobile devices, you can create subsets of it by using GroupWise distribution lists. You could organize the distribution lists by post office, by work group, or by any other meaningful subset. For instructions, see “[Creating a New Distribution List](#)” in “[Distribution Lists, Groups, and Organizational Roles](#)” in the *GroupWise 7 Administration Guide*.

Users can also choose to synchronize personal address books, as described in [Section 6.3, “Using the Web PIM to Configure Device Synchronization Settings,”](#) on page 62.

2.5 Configuring the Internet Agent to Support SMS Push

Intellisync Mobile Suite Push is a feature that allows users to automatically receive e-mail messages and PIM data updates on their mobile devices soon after the e-mail arrives or the PIM data is updated on the server. If you want to use Push for device synchronization with GroupWise mailboxes, then you must configure relaying on the GroupWise Internet Agent to allow relaying of SMS messages through the Internet Agent.

IMPORTANT: Before you implement SMS Push, make sure that your phone carrier supports it. Also be aware that, with SMS Push, all e-mail messages arrive to your mobile device as SMS messages, which can be quite expensive on some phone plans, especially if you travel abroad.

You can configure relaying at three levels of security:

- ♦ **Open SMTP relay:** Allows anyone to relay messages through the Internet Agent.
- ♦ **Domain-based/IP address SMTP relay:** Allows only users that are associated with a particular domain (for example, corporate.net) or IP address (for example, 172.16.5.18) to relay through the Internet Agent. You can also use an IP block, such as 172.16.
- ♦ **E-Mail SMTP relay:** Allows a specific e-mail address, such as bob@corporate.net, to relay through the Internet Agent.

For security reasons, Novell® recommends either a domain-based SMTP relay or an e-mail SMTP relay. If an open SMTP relay is selected, anyone can relay through your Internet Agent, which can create security issues.

For instructions on setting up an SMTP relay in the Internet Agent, see “[Enabling SMTP Relaying](#)” in “[Internet Agent](#)” in the *GroupWise 7 Administration Guide*.

2.6 Adding GroupWise Mobile Server to Your GroupWise System

Do not install GroupWise Mobile Server on the same server where a GroupWise domain, post office, or agents are already running. Select a dedicated server that meets the system requirements detailed in the *Intellisync Mobile Suite Installation Guide* (<http://www.novell.com/documentation/gwmobility>) for your platform version of GroupWise Mobile Server.

Installing GroupWise Mobile Server for Linux

3

You can meet most of the system requirements for GroupWise® Mobile Server for Linux and install the software by following the installation instructions in the *Intellisync Mobile Suite Linux Installation Guide* (http://www.novell.com/documentation/gwmobility/pdfdoc/wireless_email_linux_install/wireless_email_linux_install.pdf).

This section focuses on installation issues and common tasks that are specific to GroupWise:

- ♦ Section 3.1, “Installing GroupWise Mobile Server for Linux,” on page 19
- ♦ Section 3.2, “Starting and Stopping GroupWise Mobile Server on Linux,” on page 21
- ♦ Section 3.3, “Using the GroupWise Mobile Server WebAdmin Console,” on page 22
- ♦ Section 3.4, “Adding a GroupWise Authentication Source,” on page 23
- ♦ Section 3.5, “Adding and Configuring a GroupWise Server,” on page 24
- ♦ Section 3.6, “Completing the GroupWise Mobile Server Installation,” on page 29
- ♦ Section 3.7, “Enabling Web PIM Access,” on page 29
- ♦ Section 3.8, “Performing Optional Configuration Tasks,” on page 30
- ♦ Section 3.9, “Updating GroupWise Mobile Server for Linux,” on page 36
- ♦ Section 3.10, “Upgrading an Evaluation License on Linux,” on page 36

3.1 Installing GroupWise Mobile Server for Linux

- 1 If the server where you are planning to install GroupWise Mobile Server has Apache and Tomcat running on it, you must stop them before installing GroupWise Mobile Server.

The Secure Gateway Module of GroupWise Mobile Server automatically uses the same port numbers that Apache is configured with by default. Initially, the Secure Gateway is installed on the same server where you perform the GroupWise Mobile Server installation, but it can be installed later on additional Linux servers, as described in [Section 3.8.3, “Installing the Secure Gateway on Additional Linux Servers,” on page 31](#)

If you want to continue to run Apache and Tomcat on the same server where you are installing GroupWise Mobile Server, some post-installation reconfiguration is required, as described in [Section 3.8.4, “Running Apache on the Same Server with the Secure Gateway,” on page 33](#)

- 2 Download the GroupWise Mobile Server 2.0.3 for Linux compressed tar file (`gms203_linux.tar.gz`) from the [Novell Downloads Web site](http://www.novell.com/download) (<http://www.novell.com/download>) to a temporary directory on your Linux server.
- 3 In a terminal window, change to the temporary directory, then use the following command to extract the `gms203_linux.tar.gz` file into the temporary directory:

```
tar -xvzf gms203_linux.tar.gz
```
- 4 Become root by entering `su -` and the root password.
- 5 Change to the Novell directory:

```
cd Novell
```

- 6 To start the installer, enter the following command:

```
sh ims.bin
```

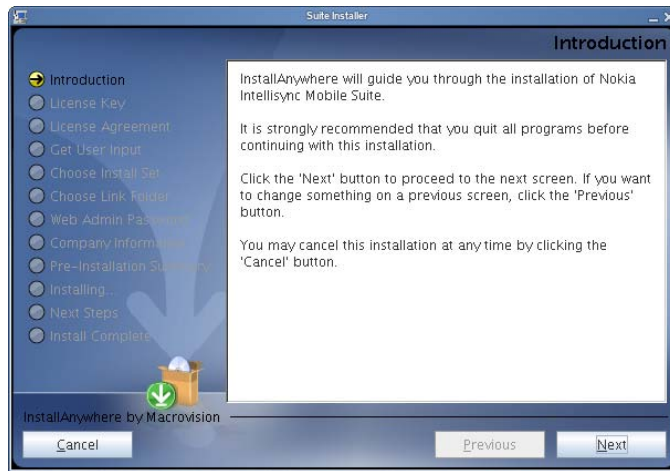

- 7 Click *Next* to input your license key.

You can use the following license key to install the evaluation version of GroupWise Mobile Server for Linux:

```
034B4A597DB4B5B4B54B104B4A4B4B0A7F
```

For evaluation entitlement and upgrade information, see [Section 1.11, "Licensing,"](#) on page 13

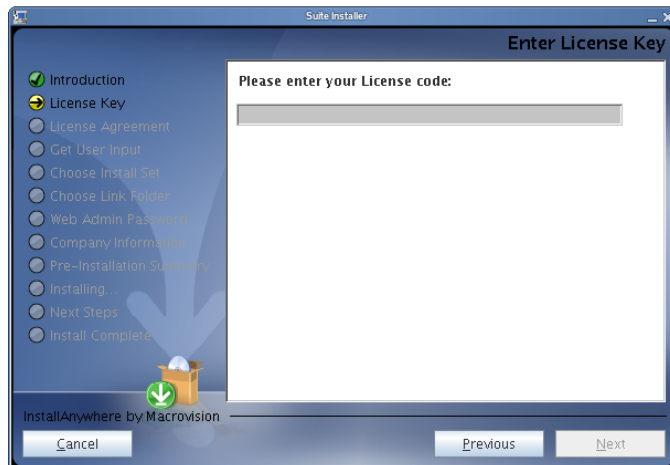

- 8 Select and copy the license key, then use Ctrl+V to paste it into the field.

- 9 Click *Next* to display the License Agreement page.

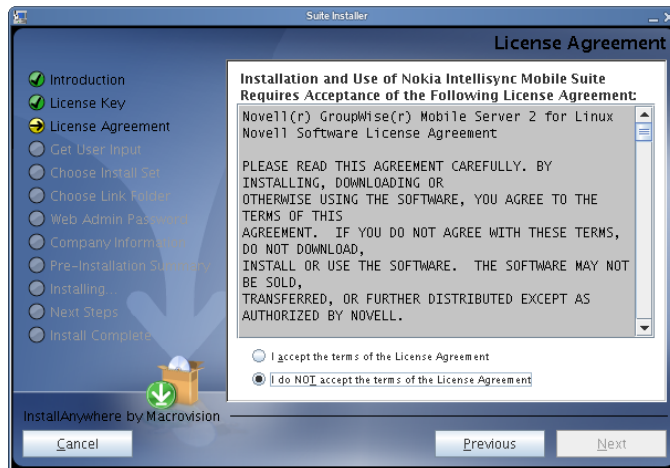

- 10 Accept the License Agreement, then click Next.



- 11 Select *Mobile Suite*, then click *Next*.
- 12 Follow the prompts, referring to the *Intellisync Mobile Suite Linux Installation Guide* (http://www.novell.com/documentation/gwmobility/pdfdoc/wireless_email_linux_install/wireless_email_linux_install.pdf) as needed, until you finish the installation and return to the command prompt.

The GroupWise Mobile Server for Linux software is installed to the `/opt/ims` directory on your Linux server.

3.2 Starting and Stopping GroupWise Mobile Server on Linux

The GroupWise Mobile Server installer should start the GroupWise Mobile Server services automatically. The following commands are useful to check status and to manually start and stop GroupWise Mobile Server.

3.2.1 Checking the Status of GroupWise Mobile Server

Use the following commands:

```
/etc/init.d/mobilesuite status  
/etc/init.d/securegateway status  
/etc/init.d/asadb status
```

3.2.2 Starting GroupWise Mobile Server

Use the following commands:

```
/etc/init.d/asadb start  
/etc/init.d/securegateway start  
/etc/init.d/mobilesuite start
```

3.2.3 Stopping GroupWise Mobile Server

Use the following commands:

```
/etc/init.d/asadb stop  
/etc/init.d/securegateway stop  
/etc/init.d/mobilesuite stop
```

3.3 Using the GroupWise Mobile Server WebAdmin Console

- 1 From your Web browser, open the WebAdmin Console:

<http://localhost/admin>

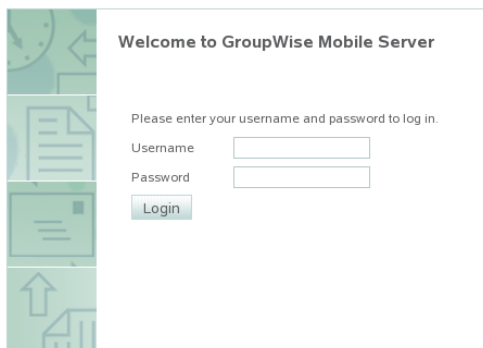

- 2 Log in, using `admin` as the username and the password you specified during installation. You can change your WebAdmin Console password after the first time you log into the WebAdmin Console, as described in [Section 4.7.2, “Accessing the WebAdmin Console from Your Web Browser,”](#) on page 50.

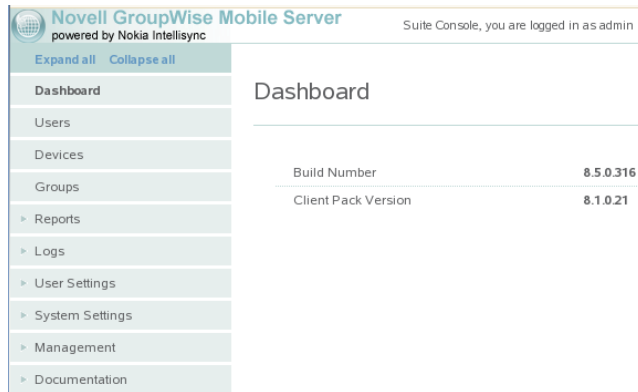

3.4 Adding a GroupWise Authentication Source

A GroupWise authentication source is a program that GroupWise Mobile Server can communicate with in order to log in to your GroupWise system. GroupWise Mobile Server needs to contact a POA that has been configured for SOAP in order to authenticate.

- 1 In the **WebAdmin Console**, click *System Settings > Authentication > Sources*.

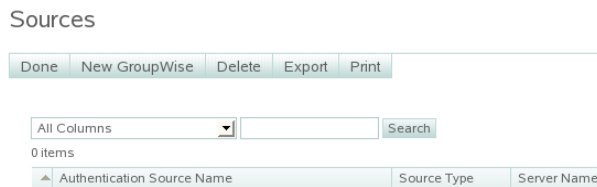

- 2 On the *Sources* page, click *New GroupWise*

Create GroupWise Authentication Source

Save Cancel

* Authentication Source Name

* GroupWise Server

* Port

Use SSL

* Username

* Password

* – Required field

Save Cancel

- 3 In the *Authentication Source Name* field, specify a name for the authentication source.
The authentication source name can be any name you want; for example, GroupWise POA.
- 4 In the *GroupWise Server* field, specify the IP address or DNS hostname of the GroupWise POA to use for authentication.
This POA must have SOAP enabled, as described in [Section 2.2, “Enabling POAs for SOAP,” on page 15](#).
- 5 In the *Port* field, specify the port number to use.

The default port number is 7191.

- 6 Select *Use SSL* if the POA is configured to require a secure SSL connection with GroupWise Mobile Server, as described in [Section 2.2, “Enabling POAs for SOAP,”](#) on page 15.
- 7 Specify a valid GroupWise username and password, as described in [Section 2.3, “Selecting a Test User and POA,”](#) on page 16, so that GroupWise Mobile Server can authenticate to the POA you specified above.
- 8 Click *Save*.
A message information you that GroupWise Mobile Server has successfully connected to the POA.
- 9 Click *Done*.

3.5 Adding and Configuring a GroupWise Server

In addition to communicating with a GroupWise authentication source, GroupWise Mobile Server also needs to communicate with a POA to synchronize GroupWise PIM data from GroupWise mailboxes to mobile devices. You can select the same POA that you are using as a GroupWise authentication source to provide this function, or you can select a different POA. The selected POA must be configured for SOAP, as described in [Section 2.2, “Enabling POAs for SOAP,”](#) on page 15. Configuring a GroupWise server for GroupWise Mobile Server includes the following tasks:

- ♦ [Section 3.5.1, “Providing Server Information,”](#) on page 24
- ♦ [Section 3.5.2, “Configuring GroupWise Mobile Server Access to GroupWise,”](#) on page 25
- ♦ [Section 3.5.3, “Configuring User Options,”](#) on page 26
- ♦ [Section 3.5.4, “Configuring GroupWise Address Book Synchronization,”](#) on page 26
- ♦ [Section 3.5.5, “Creating Multiple Profiles,”](#) on page 28

3.5.1 Providing Server Information

- 1 In the [WebAdmin Console](#), click *User Settings > Wireless Email > Novell GroupWise*.
- 2 On the *Novell GroupWise Access* tab, click *Edit*.

Edit: Default

Save Cancel

Novell GroupWise Access Novell GroupWise User Settings

To assign different settings to particular users or groups, [click here](#)

* Setting Name

GroupWise Server

Server name

Port

Use SSL

GroupWise SOAP interface: http://7191/soap

The steps in this procedure guide you through creating the default profile for a GroupWise server. If you have groups of users that you want to have settings different from the default, you can repeat this procedure multiple times, as described in [Section 3.5.5, “Creating Multiple Profiles,”](#) on page 28.

- 3 In the *Server Name* field, specify the POA's IP address or DNS hostname. Additional fields appear on the *Novell GroupWise Access* tab.

Edit: Default

The screenshot shows a configuration window for 'Novell GroupWise Access'. At the top, there are 'Save' and 'Cancel' buttons. Below is a tabbed interface with 'Novell GroupWise Access' selected. A link says 'To assign different settings to particular users or groups, click here'. The form contains the following fields:

- * Setting Name: Default
- GroupWise Server:
 - Server name: 172.16.5.19
 - Port: 7191
- Use SSL
- GroupWise SOAP interface: http://7191/soap
- Enter a valid GroupWise username and password to verify access to the GroupWise mail server:
 - Username: [empty]
 - Password: [empty]

- 4 In the *Port* field, specify the SOAP port if it is different from the one you specified for the GroupWise authentication source.
- 5 Select *Use SSL* if the POA is configured to require a secure SSL connection with GroupWise Mobile Server, as described in [Section 2.2, “Enabling POAs for SOAP,” on page 15](#).
- 6 Specify a valid GroupWise username and password, so that GroupWise Mobile Server can connect to your GroupWise system.
- 7 Continue with [Configuring GroupWise Mobile Server Access to GroupWise](#).

3.5.2 Configuring GroupWise Mobile Server Access to GroupWise

- 1 Under the *Access GroupWise Using* heading on the *Novell GroupWise Access* tab, select how you want GroupWise Mobile Server to authenticate to the POA.

The screenshot shows the 'Access GroupWise using' section. It has three radio button options:

- Same account used to access Wireless Email: must be using GroupWise authentication, and requires storing user password on the server
- A separate GroupWise account that the user specifies
- Trusted Application (must be registered on the GroupWise server)

 Below the 'Trusted Application' option, there are two input fields:

- Application name: IntellisyncMobileSuite
- Key: [empty]

 At the bottom, there is a legend '* - Required field' and 'Save' and 'Cancel' buttons.

Same Account Used to Access Intellisync Mobile Suite: Select this option if you want GroupWise Mobile Server to use the same usernames that users are already using to access GroupWise. This is the recommended option.

Separate GroupWise Account: This option provides an additional layer of security by having your mobile device provide a generic GroupWise password to GroupWise Mobile Server. GroupWise Mobile Server then prompts you for your personal GroupWise password each time synchronization is required. However, the *Trusted Application* option provides this additional layer of security much more conveniently. Therefore, the *Separate GroupWise Account* option is not recommended unless you require the additional security and would prefer not to set up GroupWise Mobile Server as GroupWise trusted application.

Trusted Application: To review the benefits of setting up GroupWise Mobile Server as a GroupWise trusted application, see “[Trusted Applications](#)” in “[System](#)” in the *GroupWise 7 Administration Guide*. For instructions to set up GroupWise Mobile Server as a trusted application, see [Section 3.8.1, “Creating a Trusted Application on Linux,”](#) on page 30.

If you want to use this access method, you must select the first access method for your initial configuration. After you have started GroupWise Mobile Server and set up GroupWise Mobile Server as a trusted application, then repeat this procedure to select this option and specify the trusted application key.

- 2 Click *Save* to save the access settings for the default profile.
- 3 Continue with [Configuring User Options](#).

3.5.3 Configuring User Options

- 1 Continuing under *User Settings > Wireless Email > Novell GroupWise*, click the *Novell GroupWise User Settings* tab, then click *Edit*.

Edit: Default

Save Cancel

Novell GroupWise Access Novell GroupWise User Settings

Allow user override

User Options and Capabilities

- Show GroupWise UI on the registration web page & discover user's mailbox if possible
- Allow users to choose on registration web page to not connect to GroupWise
- Allow users to manually add / remove GroupWise server connections
- Delete items permanently: Don't move them to Deleted Items

- 2 Select the first three options.
- 3 If you want more information about these options, click *Help*.
- 4 Continue with [Configuring GroupWise Address Book Synchronization](#).

3.5.4 Configuring GroupWise Address Book Synchronization

- 1 Under the *Address Book Sync* heading on the *Novell GroupWise User Settings* tab, select how you want to synchronize the GroupWise Address Book to the GroupWise Mobile Server Web PIM, where users select the GroupWise PIM data that will be synchronized to their mobile devices.

NOTE: In GroupWise Mobile Server, the GroupWise Address Book is referred to as the “system address book” or the “global address list”.



- 2 If you do not want to synchronize the full GroupWise Address Book to the Web PIM, select *Don't Sync System Address Book*.

In the Web PIM, users can still select the personal address book to which their Contacts folder is mapped. Typically, this is the Frequent Contacts address book. Users can map a different address book to the Contacts folder if they would prefer a different personal address book rather than the Frequent Contacts address book. For more information, see [Section 6.3, "Using the Web PIM to Configure Device Synchronization Settings,"](#) on page 62.

- 3 If you have selected or created GroupWise distribution lists that contain subsets of the GroupWise Address Book, as described in [Section 2.4, "Using Distribution Lists for Address Book Synchronization,"](#) on page 17, complete the following steps:

- 3a Select *Sync the Members of These Distribution Lists*.

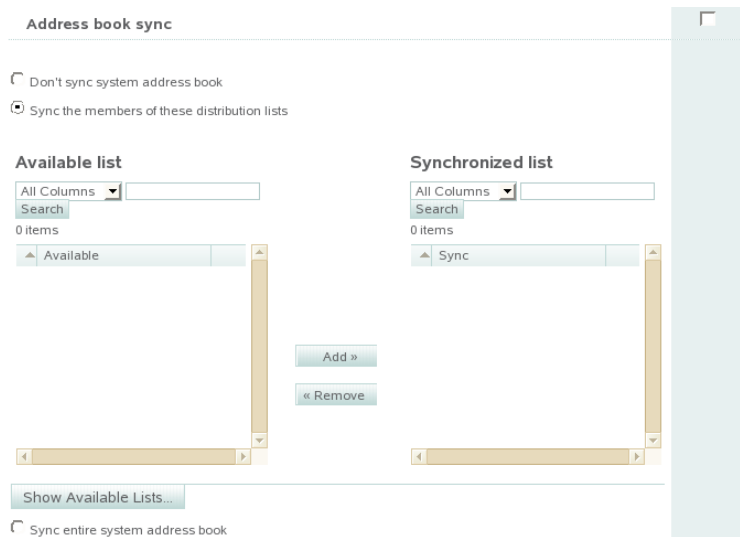

- 3b Click *Show Available Lists*.

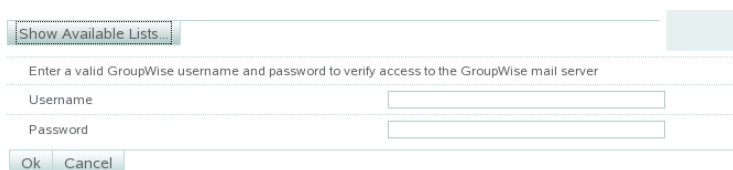

- 3c Specify a valid GroupWise username and password so that GroupWise Mobile Server can log into the post office and retrieve a list of available GroupWise distribution lists.

- 3d Select distribution lists in the *Available List*, then click *Add* to move them to the *Synchronized List*.

The selected GroupWise distribution lists will be synchronized to the Web PIM.

- 4 If you want to synchronize the full GroupWise Address Book to the Web PIM, select *Sync Entire System Address Book*.
- 5 If you want users to be able to override your synchronization setting when they use the Web PIM, select the check box to the right of the *Address Book Sync* heading in the *Allow User Override* column.
- 6 Click *Save* to save the address book synchronization settings for the default profile, then click *Done*.
- 7 If you want all users to use the default profile, skip to [Section 3.6, “Completing the GroupWise Mobile Server Installation,” on page 29](#)
or
If you want to create multiple customized profiles, so that different users can have different settings, continue with [Creating Multiple Profiles](#).
or
If you have just created a customized profile, return to [Step 5](#) in [Creating Multiple Profiles](#).

3.5.5 Creating Multiple Profiles

After creating the default profile:

- 1 On the *Novell GroupWise Access* tab, click *To Assign Different Settings to Particular Users or Groups, Click Here*.
- 2 Click *Create New Setting*.
- 3 In the *Setting Name* field, specify a meaningful name for the customized profile.
This can be any name you want. For example, if you want them to access a different POA, you might want to include the name of the post office that the POA services.
- 4 Return to [Step 3](#) in [Section 3.5.1, “Providing Server Information,” on page 24](#) to create the customized profile, then return to this point.
- 5 Observe that your customized profile has been added to the list.

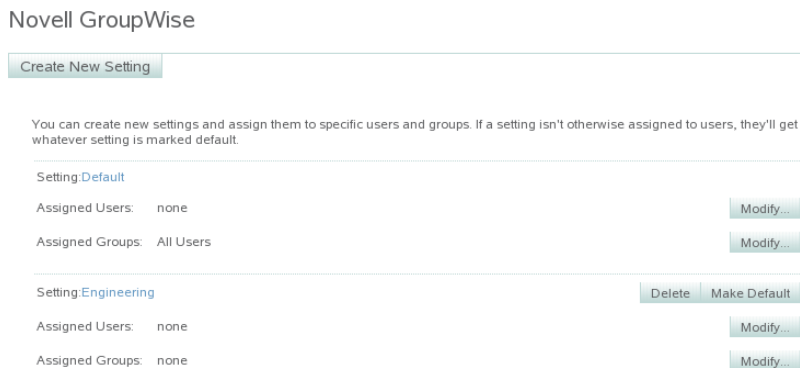

The *Settings* field displays the name of the profile that you defined in [Step 3](#) above.

- 6 Assign users and groups to the first customized profile:
 - 6a In the *Assigned Users* field for the new profile, click *Modify*, assign users to the customized profile as needed, then click *Done*.

- 6b** In the *Assigned Groups* field for the new profile, click *Modify*, assign groups of users to the customized profile as needed, then click *Done*.
- 6c** When you are finished assigning users and groups to the first customized profile, click *Create New Setting* to create additional customized profiles as needed.

3.6 Completing the GroupWise Mobile Server Installation

Continue using the guides provide by Nokia to complete the following tasks as needed:

- ◆ Installing GroupWise Mobile Server on multiple servers
- ◆ Installing the Secure Gateway on additional servers
- ◆ Setting up a remote ASA database server
- ◆ Setting up GroupWise Mobile Server in a cluster
- ◆ Testing your GroupWise Mobile Server installation

If you want to use the Intellisync Mobile Suite Push feature to automatically push GroupWise data to mobile devices, see [Section 3.8.5, “Configuring SMTP Relay for SMS Push,” on page 35](#)

3.7 Enabling Web PIM Access

The GroupWise Mobile Server Web PIM enables users to select the GroupWise PIM data that will be downloaded to their mobile devices. This includes the following tasks:

- ◆ Adding a mobile device to GroupWise Mobile Server
- ◆ Selecting personal address books to synchronize
- ◆ Selecting personal Push settings
- ◆ Selecting personal alert settings

By default, Web PIM access is not granted to users, but you can enable it.

- 1** In the [WebAdmin Console](#), click *User Settings > Wireless Email > Wireless Email User*.

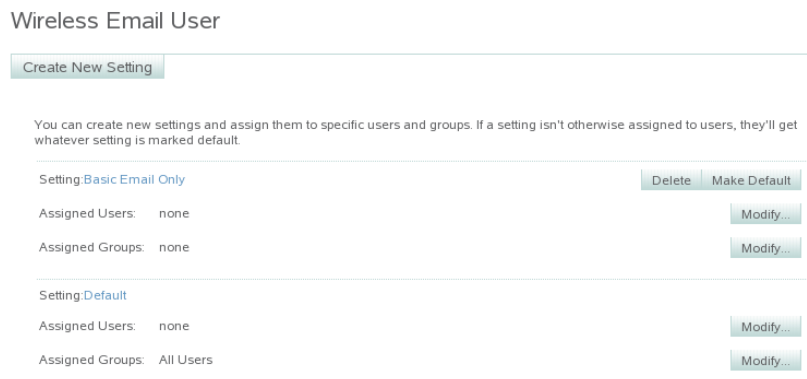

- 2** In the *Setting* field, click *Default*, then click *Edit*.

Edit: Default

Save Cancel

Settings Performance Size Limits

* Setting Name	Default	Allow user override
<input checked="" type="checkbox"/> Show Verify Your Account Settings web page to new users		
<input type="checkbox"/> Allow users to reset their Wireless Email account		
<input checked="" type="checkbox"/> Allow users to sync with SyncML devices		
<input type="checkbox"/> Enable PIM functionality on the Web (turn off to show configuration UI only)		
<input checked="" type="checkbox"/> Allow users to add and remove POP3 / IMAP server connections		
<input type="checkbox"/> Sync POP3 / IMAP mail to backend groupware mailbox		<input checked="" type="checkbox"/>
<input type="checkbox"/> Sync immediately when backend groupware data changes even if user has no push or alert devices		
<input checked="" type="checkbox"/> Import email trip itineraries		
<input checked="" type="checkbox"/> Enable content features (directions, maps, and weather)		
<input type="checkbox"/> Always add signature to the bottom of emails from devices and the web PIM		

- 3 Select *Enable PIM Functionality on the Web*, click *Save*, then click *Done*.
- 4 For instructions on using the Web PIM, see [Section 6.1, “Starting the Web PIM for the First Time,”](#) on page 61 and [Section 6.3, “Using the Web PIM to Configure Device Synchronization Settings,”](#) on page 62.

3.8 Performing Optional Configuration Tasks

- ♦ [Section 3.8.1, “Creating a Trusted Application on Linux,”](#) on page 30
- ♦ [Section 3.8.2, “Changing the WebAdmin Password,”](#) on page 31
- ♦ [Section 3.8.3, “Installing the Secure Gateway on Additional Linux Servers,”](#) on page 31
- ♦ [Section 3.8.4, “Running Apache on the Same Server with the Secure Gateway,”](#) on page 33
- ♦ [Section 3.8.5, “Configuring SMTP Relay for SMS Push,”](#) on page 35

3.8.1 Creating a Trusted Application on Linux

For background information about GroupWise trusted applications, see “[Trusted Applications](#)” in “[System](#)” in the *GroupWise 7 Administration Guide*. When you set up a trusted application, you must register GroupWise Mobile Server as a GroupWise trusted application. When GroupWise Mobile Server has been registered, a trusted application key is assigned to GroupWise Mobile Server for accessing GroupWise. Trusted applications must be set up on Windows, although they can run on Linux.

- 1 From a Windows machine where ConsoleOne and the GroupWise Administrator snap-ins are installed, map a drive to the primary domain directory in your GroupWise system.
- 2 From [Novell Downloads \(http://download.novell.com\)](http://download.novell.com), download GWTrustedApp.exe and GWTAApp.dll to a convenient location on the Windows machine.
- 3 At a command prompt, change to the directory where you downloaded the trusted application files.
- 4 Enter the following command to register GroupWise Mobile Server as a GroupWise trusted application and generate the trusted application key:

```
GWTrustedApp.exe "path_to_primary_domain"
```

A message displays, stating that trusted application was successfully registered. It also displays your trusted application key.

- 5 Transfer the trusted application key to the Linux machine where you are setting up GroupWise Mobile Server.
- 6 Return to [Step 1 in Section 3.5.2, “Configuring GroupWise Mobile Server Access to GroupWise,” on page 25](#), select *Trusted Application*, paste the trusted application key into the *Key* field, click *Save*, then click *Done*.

By default, the key allows GroupWise Mobile Server to connect to any POA in your GroupWise system. For higher security, you can configure the trusted application to allow connection to only one POA and to use SSL if desired. This higher level of security is obtained by configuring the trusted application in ConsoleOne.

- 7 In ConsoleOne, configure GroupWise Mobile Server as a GroupWise trusted application, as described in [“Editing a Trusted Application” in “System” in the *GroupWise 7 Administration Guide*](#).

3.8.2 Changing the WebAdmin Password

- 1 In the [WebAdmin Console](#), click *Management > Administrators*.



The `admin` user created during installation is listed.

- 2 Click *admin*, then click *Edit*.

Edit Administrator: admin

Save Cancel

* Administrator Name

Status

* Password

* Confirm Password

- 3 Type the new password twice, click *Save*, then click *Done*.

3.8.3 Installing the Secure Gateway on Additional Linux Servers

If you want to run the Secure Gateway on a different server from where you installed GroupWise Mobile Server, as illustrated in [Section 1.9.2, “Network Configuration with the Secure Gateway in](#)

Your DMZ,” on page 12, you must run the GroupWise Mobile Server installer again on the Linux server in your DMZ.

- 1 If the Linux server where you are planning to install the Secure Gateway has Apache and Tomcat running on it, you must stop them before installing the Secure Gateway.

If you want to continue to run Apache and Tomcat on the same server where you are installing the Secure Gateway, some post-installation reconfiguration is required, as described in **Section 3.8.4, “Running Apache on the Same Server with the Secure Gateway,” on page 33**.

- 2 Download or copy the `gms203_linux.tar.gz` file to a temporary directory on the Secure Gateway machine and extract it.
- 3 Become `root` by entering `su -` and the `root` password.
- 4 Change to the `Novell` directory:

```
cd Novell
```
- 5 To start the installer, enter the following command:

```
sh ims.bin
```
- 6 Click *Next* to input your license key.
`034B4A597DB4B5B4B54B104B4A4B4B0A7F`
- 7 Select and copy the license key, then use `Ctrl+V` to paste it into the field.
- 8 Click *Next* to display the License Agreement page, then accept the License Agreement.



- 9 Select *Secure Gateway*, then click *Next*.
- 10 Follow the prompts, until you finish the installation and return to the command prompt.
The Secure Gateway daemon (`securegatewayd`) is installed to the `/usr/sbin` directory on your Linux server.
- 11 Use the following commands to manage the Secure Gateway:

```
/etc/init.d/securegateway status  
/etc/init.d/securegateway start  
/etc/init.d/securegateway stop
```

3.8.4 Running Apache on the Same Server with the Secure Gateway

If you want to continue to use Apache on the server where you install the Secure Gateway, some post-installation configuration changes are required. You can decide whether you want to modify the configuration of the Secure Gateway or the configuration of Apache.

- ♦ “Reconfiguring the Secure Gateway to Use a Different Port Number” on page 33
- ♦ “Reconfiguring Apache to Use a Different Port Number” on page 34

Reconfiguring the Secure Gateway to Use a Different Port Number

The default HTTP ports for the Secure Gateway are port 80 for non-secure connections and port 443 for secure SSL connections. You might not want to open port 80 or port 443 to your demilitarized zone (DMZ). Therefore, you might want to change the port for the Secure Gateway from the default port to another port.

1 On the Secure Gateway machine:

1a Use a text editor to edit the `securegateway.properties` file.

By default, the `securegateway.properties` file is located in the following directory:

```
/opt/ims/conf
```

1b Locate the `#HttpPort=80` line, remove the comment character (`#`), and replace 80 with the port you want the Secure Gateway to listen on.

or

If you are using a secure SSL connection, locate the `#HttpSSLPort=443` line, remove the comment character (`#`), and replace 443 with the port you want the Secure Gateway to listen on.

1c Save the `securegateway.properties` file.

2 On the GroupWise Mobile Server machine, start the [WebAdmin Console](#).

3 Update the Secure Gateway port information.

3a Click *System Settings > Secure Gateways*.



3b Click *New*.

Create Secure Gateway

Save Cancel

* Secure Gateway Server Name

* - Required field

Save Cancel

3c Specify the Secure Gateway server, accompanied by the port you want it to use; for example:

http://www.corporate.net:8888

https://www.corporate.net:4433

3d Click *Save*, then click *Done*.

4 Update the Web server and sync server information:

4a Under *System Settings*, click *Server Names*, then click *Edit*.

Edit Server Names Settings

Save Cancel

Website Server Name [?]	gms.corporate.net
Sync Server Name [?]	gms.corporate.net
Network Push Server [?]	gms.corporate.net
Network Push Port	3102
Internal Server Name [?]	gms.corporate.net

* - Required field

Save Cancel

4b In the *Web Server Name* field, add the new port number to the existing DNS hostname with a colon (:) between them.

4c In the *Sync Server Name* field, add the new port number to the existing DNS hostname with a colon (:) between them.

4d Click *Save*, then click *Done*.

5 Restart the GroupWise Mobile Server machine.

6 Restart the Secure Gateway machine.

7 Notify existing mobile device users to add the port number to the server that their devices use for synchronization.

For instructions, see the device-specific *User Guides* at the [GroupWise Mobility Documentation Web site \(http://www.novell.com/documentation/gwmobility\)](http://www.novell.com/documentation/gwmobility).

Reconfiguring Apache to Use a Different Port Number

- 1** Become `root` by entering `su -` and the `root` password.
- 2** Change to the `/etc/apache2` directory, then use a text editor to edit the `listen.conf` file.
- 3** Change the `Listen` parameter from `80` to the port number that you want Apache to use in the future.

or

If you are using SSL, change the `Listen` parameter from 443 to the port number that you want Apache to use in the future.

- 4 Save the `listen.conf` file.
- 5 Restart Apache.

3.8.5 Configuring SMTP Relay for SMS Push

Before configuring the Push feature, you must configure the GroupWise Internet Agent as a relay host, as described in [Section 2.5, “Configuring the Internet Agent to Support SMS Push,”](#) on [page 17](#).

To configure the Push feature:

- 1 In the [WebAdmin Console](#), expand *User Settings*.
- 2 To enable/disable Push and to configure synchronization settings:
 - 2a Expand *General > Push/Interval Sync*.
 - 2b Select a device for which to configure synchronization settings (for example, Symbian), then click *Edit*.

Edit: Default

To assign different settings to particular users or groups, [click here](#)

Setting Name	Allow user override
* Setting Name	Default
<input checked="" type="checkbox"/> Enable Ready Sync	<input checked="" type="checkbox"/>
<input checked="" type="checkbox"/> Enable Push	<input checked="" type="checkbox"/>
Interval Sync and Push	
On times	
Allow On	Every day
From	12:00 AM
To	12:00 AM
<input checked="" type="checkbox"/> Initiate Network Connection	<input checked="" type="checkbox"/>
<input checked="" type="checkbox"/> Initiate even if device is powered off	<input checked="" type="checkbox"/>
<input checked="" type="checkbox"/> Display notification when data is received	<input checked="" type="checkbox"/>
<input checked="" type="checkbox"/> Disable when battery power is less than	<input checked="" type="checkbox"/>
Disable when battery power is less than	15
<input checked="" type="checkbox"/> Retry on failed connections	<input checked="" type="checkbox"/>
Initial retry interval	15 minutes
Subsequent interval	60 minutes

- 2c Click *Help* for information about the Push/ReadySync settings.
 - 2d Set the Push/Interval Sync settings as needed for your mobile users who use the selected device.
 - 2e Click *Save* to save the Push/Interval Sync settings.
 - 2f Repeat [Step 2b](#) through [Step 2e](#) for each device used by your mobile users
- 3 To configure the types of items that are pushed to mobile devices:
 - 3a Expand *Wireless Email > Push*.
 - 3b In the *Setting* field, click *Default*, then click *Edit*.

Edit: Default

Save Cancel

Setting Name	Value	Allow user override
Information to monitor		
<input checked="" type="checkbox"/> Email		<input checked="" type="checkbox"/>
<input checked="" type="checkbox"/> Contacts		<input checked="" type="checkbox"/>
<input checked="" type="checkbox"/> Notes		<input checked="" type="checkbox"/>
<input checked="" type="checkbox"/> Calendar		<input checked="" type="checkbox"/>
<input checked="" type="checkbox"/> Tasks		<input checked="" type="checkbox"/>
Push schedule		
Push information	Every day	<input checked="" type="checkbox"/>
<input type="checkbox"/> Limit push to the following interval		
From	6:00 AM	
To	10:00 PM	
Email Push Settings		
<input checked="" type="radio"/> Push all email		<input checked="" type="checkbox"/>
<input type="radio"/> Push emails based on the following limits		

- 4 Click *Help* for information about the Push settings.
- 5 Set the Push settings as needed for your mobile device users.
These settings apply to all mobile devices.
- 6 Click *Save* to save the Push settings, then click *Done*.

3.9 Updating GroupWise Mobile Server for Linux

When you update GroupWise Mobile Server for Linux, you must uninstall your current version before you install the updated version. See the following sections of the *Intellisync Mobile Suite Linux Installation Guide* (http://www.novell.com/documentation/gwmobility/pdfdoc/wireless_email_linux_install/wireless_email_linux_install.pdf) for instructions:

- ♦ “Uninstalling an Existing Linux Version of Intellisync Mobile Suite”
- ♦ “Restoring Existing Data”

For instructions on how to install GroupWise Mobile Server, see [Section 3.1, “Installing GroupWise Mobile Server for Linux,”](#) on page 19.

3.10 Upgrading an Evaluation License on Linux

For general GroupWise Mobile Server licensing entitlements, see [Section 1.11, “Licensing,”](#) on page 13. Use the [Novell Customer Care Portal](http://www.novell.com/company/customer) (<http://www.novell.com/company/customer>) to upgrade an evaluation license to a permanent license.

After you have installed GroupWise Mobile Server for Linux and obtained a permanent license key:

- 1 In the **WebAdmin Console**, click *System Settings > License*, then click *Edit*.

Edit License

Save Cancel

* License Key

License Details

Install Date	04/07/2008 12:00:00 AM
Status	Valid
Users	Unlimited Users
Expiration	Evaluation license will expire in 174 days.
Customer ID	4663
Products	Wireless Email Handheld

* - Required field

Save Cancel

- 2 Delete the evaluation license key from the *License Key* field.
- 3 Select and copy your permanent license key into the *License Key* field.
- 4 Click *Save* to put the new license into effect, then click *Done*.

Installing GroupWise Mobile Server for Windows

4

You can meet most of the system requirements for GroupWise® Mobile Server for Windows and install the software by following the installation instructions in the *Intellisync Mobile Suite Installation Guide* (http://www.novell.com/documentation/gwmobility/pdfdoc/install_gde/install_gde.pdf).

NOTE: Keep in mind that the Nokia guide describes the Device Management, File Sync, and Application Sync modules, which are *not* part of GroupWise Mobile Server, but which can be purchased separately from [Nokia](http://www.nokia.com) (<http://www.nokia.com>).

This section focuses on installation issues and common tasks that are specific to GroupWise:

- ♦ [Section 4.1, “Installing GroupWise Mobile Server for Windows,” on page 39](#)
- ♦ [Section 4.2, “Starting and Stopping GroupWise Mobile Server on Windows,” on page 43](#)
- ♦ [Section 4.3, “Using the Admin Console,” on page 43](#)
- ♦ [Section 4.4, “Configuring a GroupWise Server,” on page 44](#)
- ♦ [Section 4.5, “Completing the GroupWise Mobile Server Installation,” on page 48](#)
- ♦ [Section 4.6, “Enabling Web PIM Access,” on page 48](#)
- ♦ [Section 4.7, “Performing Optional Configuration Tasks,” on page 49](#)
- ♦ [Section 4.8, “Updating GroupWise Mobile Server for Windows,” on page 54](#)
- ♦ [Section 4.9, “Upgrading an Evaluation License on Windows,” on page 54](#)

4.1 Installing GroupWise Mobile Server for Windows

- 1** If the server where you are planning to install GroupWise Mobile Server has a Web server running on it, you must stop it before installing GroupWise Mobile Server.
- 2** Download the GroupWise Mobile Server compressed executable file (`gms204.exe`) from the [Novell download Web site](http://www.novell.com/download) (<http://www.novell.com/download>) to a temporary directory on your Windows server.
- 3** Extract the `.exe` file into a directory at the root of your local drive or to a network server drive that can handle long pathnames.
The compressed file contains directory paths that could exceed DOS limits.
- 4** In Windows, click *Start > Run > Browse*, then locate the directory where you extracted the GroupWise Mobile Server files.
- 5** Select the `setup.exe` file, then click *OK* to run the GroupWise Mobile Server Installation program.
- 6** Click *Next*. The contents of the installation package extract and the Welcome dialog box appears.

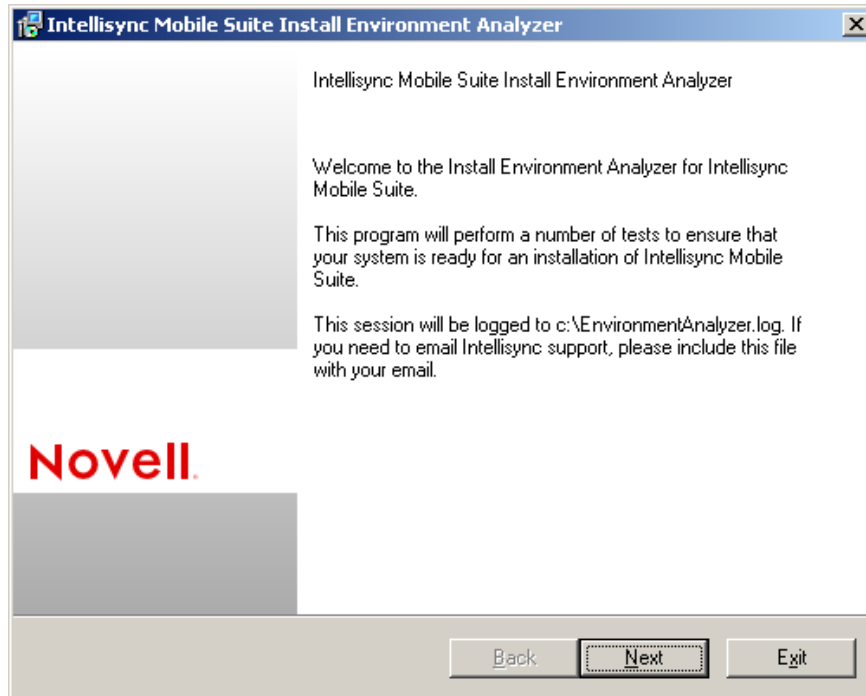

- 7 Click *Next* to display the License Agreement dialog box.

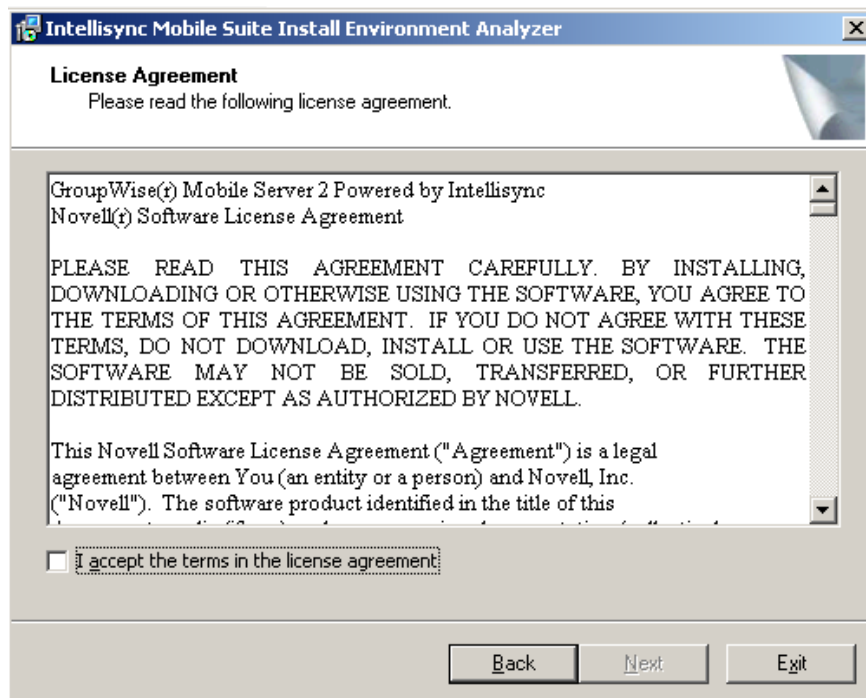

- 8 Read the Novell GroupWise Mobile Server License Agreement, accept the License Agreement, then click *Next*.

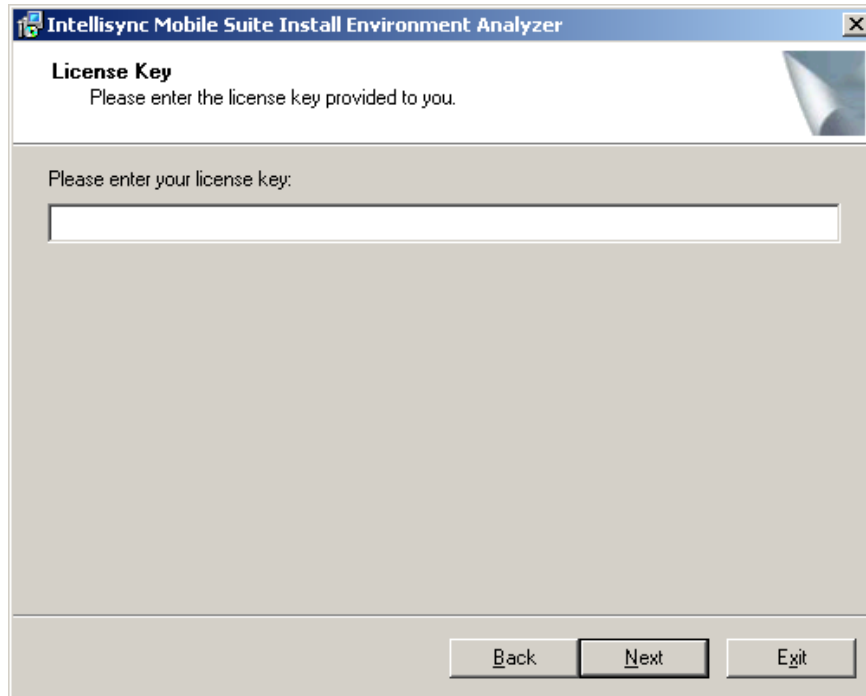

- 9 Specify the license key for your software, then click *Next*.

You can use the following license key to install the evaluation version of GroupWise Mobile Server for Windows:

034B4A597DB4B5B4B54B104B4A4B4B0A7F

- 10 Follow the prompts, referring to the *Intellisync Mobile Suite Installation Guide* (http://www.novell.com/documentation/gwmobility/pdfdoc/install_gde/install_gde.pdf) as needed, until you reach the Mail Server page.

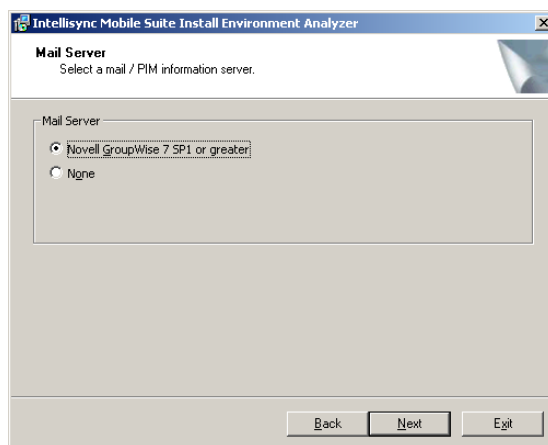

- 11 Select *Novell GroupWise 7 SP1 or greater*, then click *Next*.

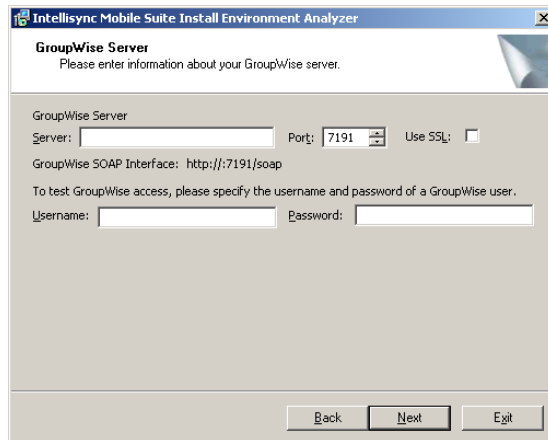

12 Provide the information required for GroupWise Mobile Server to access a POA:

12a Specify the IP address or full DNS hostname for the GroupWise server where a POA configured for SOAP is running, as described in [Section 2.2, “Enabling POAs for SOAP,” on page 15](#)

12b Specify the SOAP port for the POA.

The default port is 7191.

12c Select *Use SSL* if the POA is configured to require a secure SSL connection with GroupWise Mobile Server, as described in [Section 2.2, “Enabling POAs for SOAP,” on page 15](#).

12d Specify a GroupWise username and password to test the connection between GroupWise Mobile Server and the POA, as described in [Section 2.3, “Selecting a Test User and POA,” on page 16](#).

13 Click *Next*.

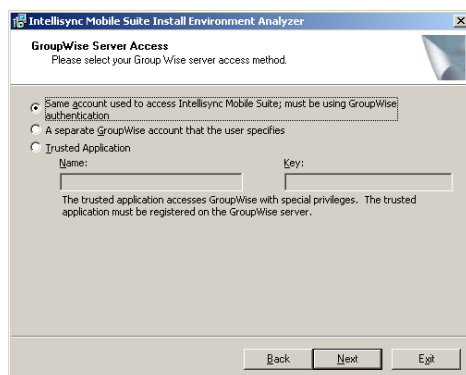

14 Select the method that you want mobile devices to use when authenticating to the POA for the post office where the mobile device user’s mailbox is located.

Same Account Used to Access Intellisync Mobile Suite: Select this option if you want GroupWise Mobile Server to use the same usernames that users are already using in GroupWise. This is the recommended option.

Separate GroupWise Account: This option provides an additional layer of security by having your mobile device provide a generic password to GroupWise Mobile Server. GroupWise Mobile Server then prompts you for your GroupWise password each time synchronization is

required. The *Trusted Application* option provides this additional layer of security much more conveniently. Therefore, the *Separate GroupWise Account* option is not recommended.

Trusted Application: To review the benefits of setting up GroupWise Mobile Server as a GroupWise trusted application, see “**Trusted Applications**” in “**System**” in the *GroupWise 7 Administration Guide*. For instructions specific to setting up GroupWise Mobile Server as a trusted application, see **Section 4.7.1, “Creating a Trusted Application on Windows,”** on **page 49**. If you want to use this access method, you must select one of the other two access methods for your initial installation, start GroupWise Mobile Server, set up GroupWise Mobile Server as a trusted application, then repeat the installation to select this option and specify the trusted application key.

- 15 Click *Next*, then continue following the prompts, referring to the *Intellisync Mobile Suite Installation Guide* (http://www.novell.com/documentation/gwmobility/pdfdoc/install_gde/install_gde.pdf) as needed, until you complete the GroupWise Mobile Server installation.

4.2 Starting and Stopping GroupWise Mobile Server on Windows

To check the current status of GroupWise Mobile Server:

- 1 On your Windows server desktop, click *Start > Administrative Tools > Services*.
- 2 Scroll down to the Intellisync services:
 - ♦ Intellisync Mobile Gateway
 - ♦ Intellisync Mobile Suite
 - ♦ Intellisync Secure Gateway
 - ♦ Intellisync Systems Management
- 3 Make sure that the first three Intellisync services are running.

The Intellisync Systems Management service is not required by GroupWise Mobile Server.

To start or stop GroupWise Mobile Server:

- 1 In the **Admin Console**, expand the Intellisync Mobile Suite object, then click *Servers*.
- 2 Right-click the GroupWise Mobile Server machine, then click *Start* or *Stop*.

4.3 Using the Admin Console

The GroupWise Mobile Server Admin Console enables you to configure settings that are specific to GroupWise and to manage GroupWise Mobile Server.

- 1 On the Windows desktop where you installed GroupWise Mobile Server, click *Start > All Programs > Intellisync Mobile Suite > Admin Console*.

For convenience, you might want to create a desktop shortcut for the Admin Console.

- 2 Expand the Intellisync Mobile Suite object to connect the Admin Console to GroupWise Mobile Server.

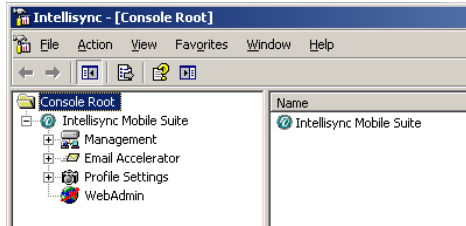

4.4 Configuring a GroupWise Server

During installation, basic GroupWise configuration information is imported into GroupWise Mobile Server.

- ◆ [Section 4.4.1, “Viewing Initial Configuration Information,” on page 44](#)
- ◆ [Section 4.4.2, “Configuring User Options,” on page 45](#)
- ◆ [Section 4.4.3, “Configuring GroupWise Address Book Synchronization,” on page 45](#)
- ◆ [Section 4.4.4, “Creating Multiple Profiles,” on page 46](#)

4.4.1 Viewing Initial Configuration Information

- 1 In the **Admin Console**, expand *Profile Settings > Email Accelerator > Novell GroupWise*.
- 2 Right-click *Default*, then click *Properties* to display the Access page.

The steps in this procedure guide you through creating the default profile for GroupWise. If you have groups of users that you want to have settings different from the default, you can repeat this procedure multiple times, as described in [Section 4.4.4, “Creating Multiple Profiles,” on page 46](#).

- 3 Change access settings as needed.

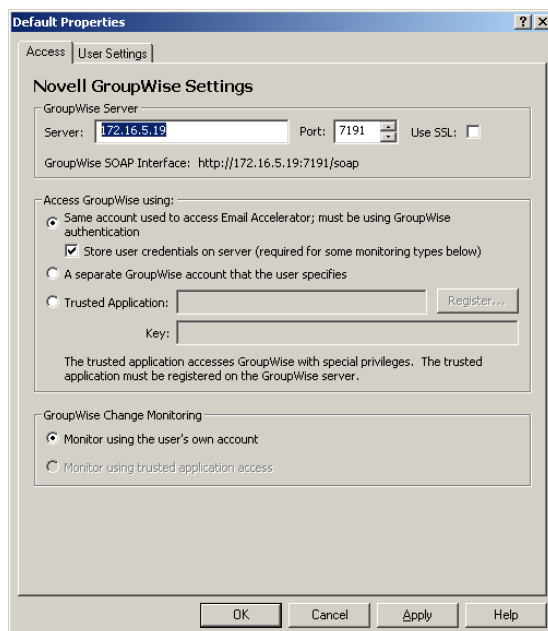

- 4 Click *Apply* to save the access settings for the default profile, then continue with [Configuring User Options](#).

4.4.2 Configuring User Options

- 1 Continuing under *Profile Settings > Email Accelerator > Novell GroupWise > Default*, click the *User Settings* tab.

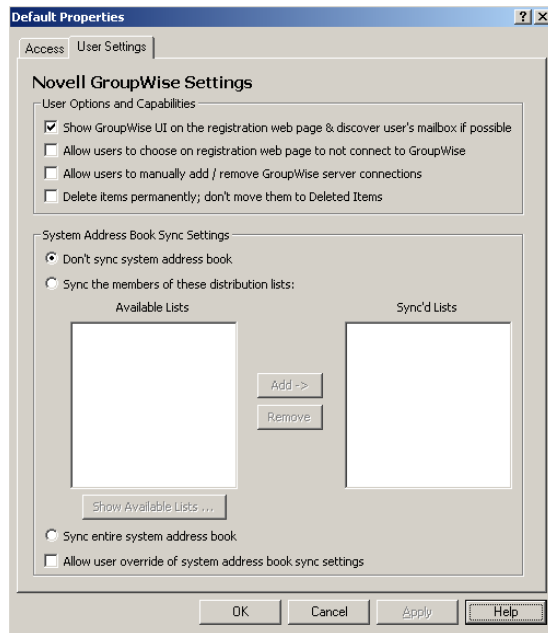

- 2 In the *User Options and Capabilities* box, select the first three options, then click *Apply* to save the user options for the default profile.
- 3 Continue with [Configuring GroupWise Address Book Synchronization](#).

4.4.3 Configuring GroupWise Address Book Synchronization

After setting the user options:

- 1 In the *System Address Book Sync Settings* box on the *User Settings* tab, select how you want to synchronize the GroupWise Address Book to the GroupWise Mobile Server Web PIM, where users select the GroupWise PIM data that will be synchronized to their mobile devices.

NOTE: In GroupWise Mobile Server, the GroupWise Address Book is referred to as the “system address book” or the “global address list”.

- 2 If you do not to synchronize the full GroupWise Address Book to the Web PIM, select *Don't Sync System Address Book*.

In the Web PIM, users can still select the personal address book to which their Contacts folder is mapped. Typically, this is the Frequent Contacts address book. Users can map a different address book to the Contacts folder if they would prefer a different personal address book rather than the Frequent Contacts address book. For more information, see [Section 6.3, “Using the Web PIM to Configure Device Synchronization Settings,”](#) on page 62.

- 3** If you have selected or created GroupWise distribution lists that contain subsets of the GroupWise Address Book, as described in [Section 2.4, “Using Distribution Lists for Address Book Synchronization,”](#) on page 17, complete the following steps:

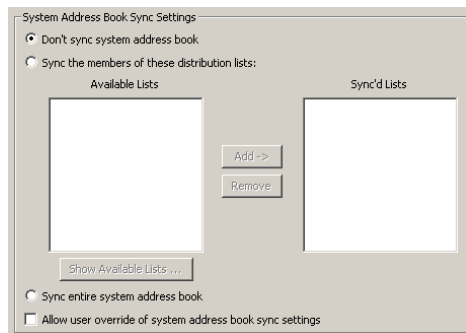

- 3a** Select *Sync the Members of These Distribution Lists*.
- 3b** Click *Show Available Lists*.
- 3c** Specify a valid GroupWise username and password so that GroupWise Mobile Server can log into the post office and retrieve a list of available distribution lists.
- 3d** Select distribution lists in the *Available List*, then click *Add* to move them to the *Sync'd List*.

The selected GroupWise distribution lists will be synchronized to the Web PIM

- 4** If you want to synchronize the full GroupWise Address Book to the Web PIM, select *Sync Entire System Address Book*.
- 5** If you want users to be able to override your synchronization setting when they use the Web PIM, select *Allow User Override of System Address Book Sync Settings*.
- 6** Click *OK* to save the address book synchronization settings for the default profile.
- 7** If you want all users to use the default profile, skip to [Section 4.5, “Completing the GroupWise Mobile Server Installation,”](#) on page 48

or

If you want to create multiple customized profiles, so that different users can have different settings, continue with [Creating Multiple Profiles](#)

or

If you have just created a custom profile, return to [Step 4 in Creating Multiple Profiles](#).

4.4.4 Creating Multiple Profiles

After creating the default profile:

- 1** Under *Profile Settings > Email Accelerator*, right-click *Novell GroupWise*, then click *Create New Setting*.

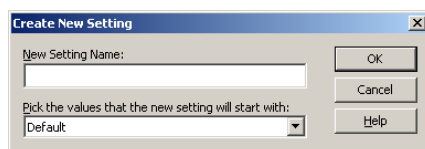

- 2 In the *New Setting Name* field, specify a meaningful name for the customized profile, then click *OK*.

This can be any name you want. For example, if you want them to access a different POA, you might want to include the name of the post office that the POA services.

- 3 Return to **Step 3** in **Section 4.4.1, “Viewing Initial Configuration Information,”** on page 44 to create the profile of customized settings, then return to this point.
- 4 To assign the customized profile to selected users or a specified group of users:
 - 4a Expand *Management*.
 - 4b Click *Users* or *Groups*, then select the users or groups that you want to assign the profile to.
 - 4c Right-click the selected users or groups, then click *Properties*.

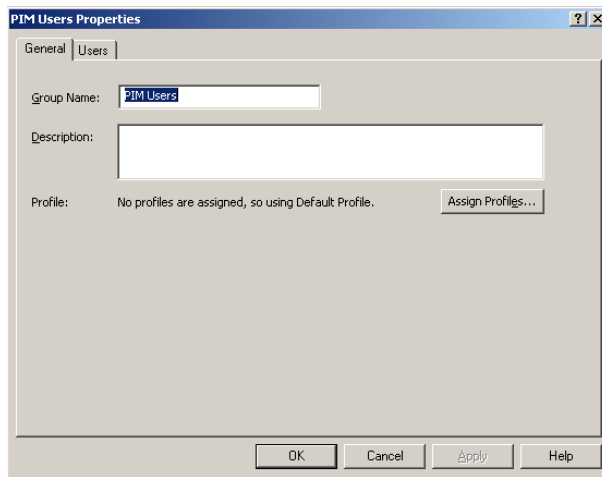

This example shows the properties of a group.

- 4d Click *Assign Profiles*, then click the *Server* tab.

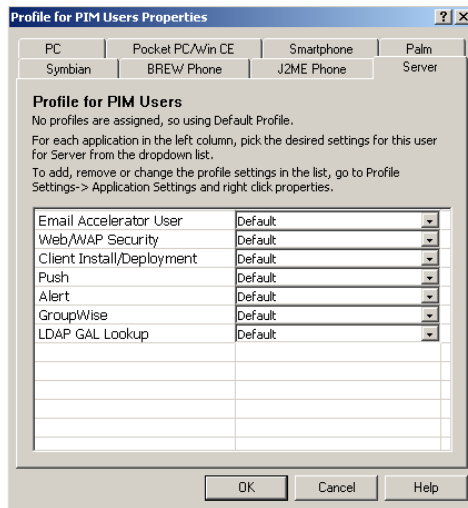

- 4e In the *Email Accelerator User* drop-down list, select the customized profile that you just created, then click *OK* to assign that profile to the selected group.

4f Repeat [Step 4b](#) through [Step 4e](#) to assign other custom profiles to other users and groups.

4.5 Completing the GroupWise Mobile Server Installation

Continue using the guides provide by Nokia to complete the following tasks as needed:

- ♦ Installing GroupWise Mobile Server on multiple servers
- ♦ Installing the Secure Gateway (recommended)
- ♦ Setting up a remote ASA database server
- ♦ Setting up GroupWise Mobile Server in a cluster
- ♦ Testing your GroupWise Mobile Server installation

If you want to use the Intellisync Mobile Suite Push feature to automatically push GroupWise data to mobile devices, continue with [Section 4.7.4, “Configuring SMTP Relay for SMS Push,”](#) on [page 53](#)

4.6 Enabling Web PIM Access

The GroupWise Mobile Server Web PIM enables users to select the GroupWise PIM data that will be downloaded to their mobile devices. This includes the following tasks:

- ♦ Adding a mobile device to GroupWise Mobile Server
- ♦ Selecting personal address books to synchronize
- ♦ Selecting personal Push settings
- ♦ Selecting personal alert settings

By default, Web PIM access is not granted to users, but you can enable it.

- 1 In the [Admin Console](#), click *Profile Settings* > *Email Accelerator* > *Email Accelerator User*.
- 2 Right-click *Default*, then click *Properties*.

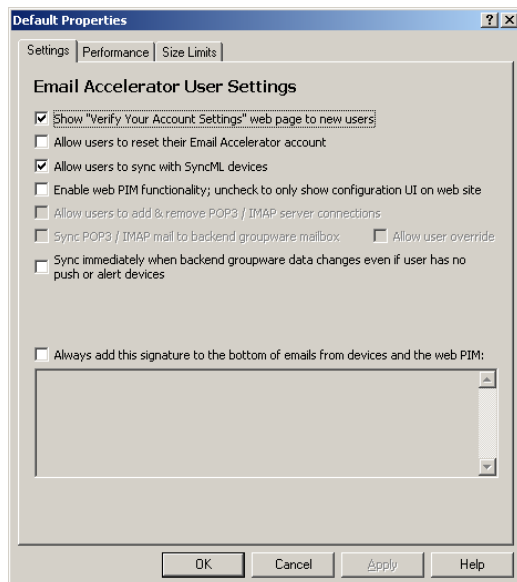

- 3 Select *Enable Web PIM Functionality*, then click *OK*.
- 4 For instructions on using the Web PIM, see [Section 6.1, “Starting the Web PIM for the First Time,”](#) on page 61 and [Section 6.3, “Using the Web PIM to Configure Device Synchronization Settings,”](#) on page 62.

4.7 Performing Optional Configuration Tasks

- ♦ [Section 4.7.1, “Creating a Trusted Application on Windows,”](#) on page 49
- ♦ [Section 4.7.2, “Accessing the WebAdmin Console from Your Web Browser,”](#) on page 50
- ♦ [Section 4.7.3, “Reconfiguring the Secure Gateway to Use a Different Port Number,”](#) on page 51
- ♦ [Section 4.7.4, “Configuring SMTP Relay for SMS Push,”](#) on page 53

4.7.1 Creating a Trusted Application on Windows

For background information about GroupWise trusted applications, see “[Trusted Applications](#)” in “[System](#)” in the *GroupWise 7 Administration Guide*. When you set up a trusted application, you must register GroupWise Mobile Server as a GroupWise trusted application. When GroupWise Mobile Server has been registered, a trusted application key is assigned to GroupWise Mobile Server for accessing GroupWise.

- 1 From your Windows server, map a drive to the primary domain directory in your GroupWise system.
- 2 On the GroupWise Mobile Server machine, open a command window.
- 3 Change to the following directory:
`C:\Program Files\Intellisync Mobile Suite\PIM`
- 4 Enter the following command to register GroupWise Mobile Server as a GroupWise trusted application and generate the trusted application key:
`GWTrustedApp.exe "path_to_primary_domain"`
A message displays, stating that trusted application was successfully registered. It also displays your trusted application key.
- 5 Copy the key to the Windows clipboard.
- 6 In the [Admin Console](#), click *Intellisync Mobile Suite* to connect the console to GroupWise Mobile Server.
- 7 Expand *Profile Settings > Email Accelerator > Novell GroupWise*.
- 8 Right-click *Default*, then click *Properties*.

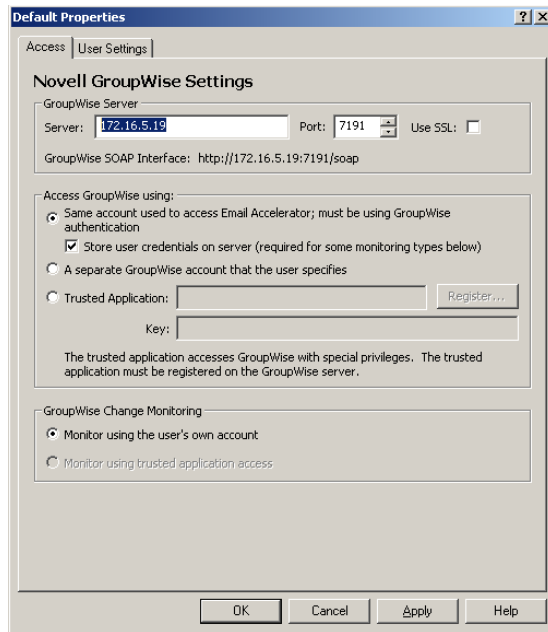

- 9 Select *Trusted Application*, then paste the trusted application key into the *Key* field.
- 10 Click *OK*, then specify a valid GroupWise username and password of a user on the POA.
- 11 Click *OK*.

By default, the key allows GroupWise Mobile Server to connect to any POA in your GroupWise system. For higher security, you can configure the trusted application to allow connections to only one POA and to use SSL if necessary. This higher level of security is obtained by configuring the trusted application in ConsoleOne.

- 12 In ConsoleOne, configure GroupWise Mobile Server as a GroupWise trusted application, as described in “[Editing a Trusted Application](#)” in “[System](#)” in the *GroupWise 7 Administration Guide*.
- 13 To apply the settings, reboot the GroupWise Mobile Server machine.

4.7.2 Accessing the WebAdmin Console from Your Web Browser

By default, you can access the WebAdmin Console only from the Admin Console. If you want to be able to access the WebAdmin Console directly from your Web browser, you must create an administrative user for this purpose.

- 1 Access the WebAdmin Console from the [Admin Console](#).
 - 1a Click *Intellisync Mobile Suite* to connect the console to GroupWise Mobile Server.
 - 1b Click the WebAdmin object, then click *Actions > Launch WebAdmin*.

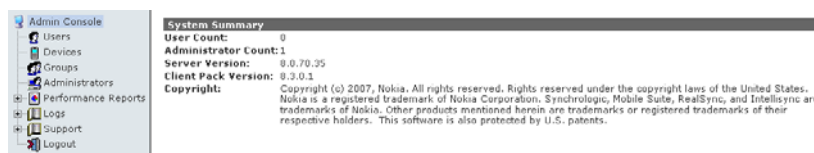

- 2 In the WebAdmin Console, click *Administrators*.

Administrator Name	Description	Status	Created
sysadmin	The sysadmin administrator is a special administrator used or	Active	04/12/2008 10:52:40 AM

By default, the Admin Console uses the `sysadmin` user to connect to the WebAdmin console.

- 3 To create your own administrative account, click *Add*.

Save | Close | Help

Add Administrator

Administrator Name: Status: Active

Password:

Confirm Password:

Time Zone: Mountain Time (US & Canada) (GMT-7:00)

Language: English

Locale: United States

Description:

- 4 Specify the administrative username and password, change other settings as needed, then click *Save*.

The new administrative user is added to the list. You can now use this username and password to access the WebAdmin Console directly from your Web browser.

4.7.3 Reconfiguring the Secure Gateway to Use a Different Port Number

The default HTTP ports for the Secure Gateway are port 80 for non-secure connections and port 443 for secure SSL connections. You might not want to open port 80 or port 443 to your demilitarized zone (DMZ). Therefore, you might want to change the port for the Secure Gateway from the default port to another port.

- 1 On the Secure Gateway machine,
 - 1a Use a text editor to edit the `securegateway.properties` file.

By default, the `securegateway.properties` file is located in the following directory:

```
C:\Program Files\Secure Gateway\CommSvr\conf
```
 - 1b Locate the `#HttpPort=80` line, remove the comment character (`#`), and replace 80 with the port you want the Secure Gateway to listen on.

or

If you are using an SSL connection, locate the `#HttpSSLPort=443` line, remove the comment character (`#`), and replace 443 with the port you want the Secure Gateway to listen on.
 - 1c Save the `securegateway.properties` file.
- 2 On the GroupWise Mobile Server machine, start the **Admin Console**.
- 3 Update the Secure Gateway port information.

- 3a** Right-click the Intellisync Mobile Suite object, then click *Properties*.
- 3b** Click the *Secure Gateway* tab.

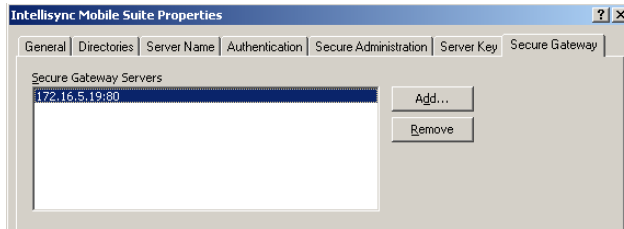

- 3c** If a Secure Gateway server is already listed, select it, then click *Remove*.
- 3d** Click *Add*.

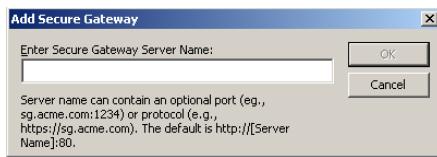

- 3e** Specify the IP address or DNS hostname and port number, then click *OK*; for example:
 http://www.corporate.net:8888
 https://www.corporate.net:4433
- 3f** Click *OK* to save the updated list of Secure Gateway servers.

- 4** Update the Web server and sync server information:
 - 4a** Click the *Server Name* tab.

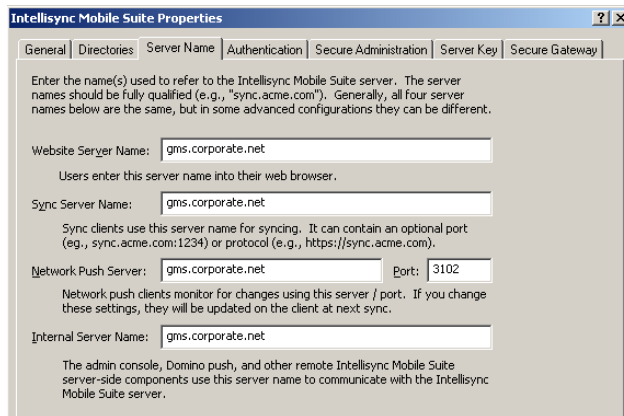

- 4b** In the *Web Server Name* field, add the new port number to the existing DNS hostname with a colon (:) between them.
- 4c** In the *Sync Server Name* field, add the new port number to the existing DNS hostname with a colon (:) between them.
- 4d** Click *OK* to save the changes.
- 5** Restart the GroupWise Mobile Server machine.
- 6** Restart the Secure Gateway machine.

- 7 Notify existing mobile device users to add the port number to the server that their devices use for synchronization.

For instructions, see the device-specific *User Guides* at the [GroupWise Mobility Documentation Web site](http://www.novell.com/documentation/gwmobility) (<http://www.novell.com/documentation/gwmobility>).

4.7.4 Configuring SMTP Relay for SMS Push

Before configuring the Push feature, you must configure the GroupWise Internet Agent as a relay host, as described in [Section 2.5, “Configuring the Internet Agent to Support SMS Push,”](#) on [page 17](#).

To configure the Push feature:

- 1 In the **Admin Console**, expand *Profile Settings*.
- 2 To enable/disable Push, and to configure synchronization settings:
 - 2a Expand *General > Push/ReadySync*.
 - 2b Right-click *Default*, then click *Properties*.

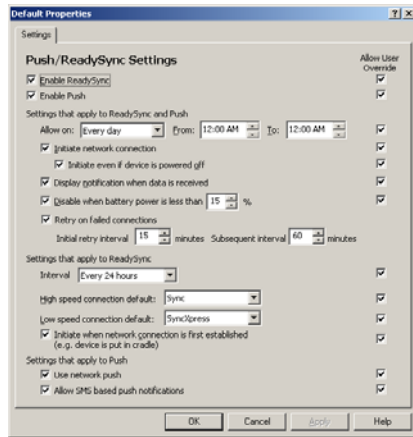

- 2c Click *Help* for information about the Push/ReadySync settings.
 - 2d Set the Push/ReadySync settings as needed for your mobile users.
 - 2e Click *OK* to save the Push/ReadySync settings.
- 3 To configure the types of items that are pushed to mobile devices:
 - 3a Expand *Email Accelerator > Push*.
 - 3b Right-click *Default*, then click *Properties*.

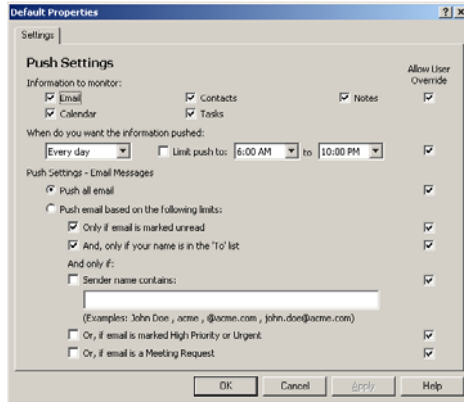

- 4 Click *Help* for information about the Push settings.
- 5 Set the Push settings as needed for your mobile users.
- 6 Click *OK* to save the Push settings.

4.8 Updating GroupWise Mobile Server for Windows

When updating GroupWise Mobile Server for Windows, you can install the new version of GroupWise Mobile Server over a previous version. You do not need to uninstall GroupWise Mobile Server before installing the new version. For instructions on how to install GroupWise Mobile Server, see [Section 4.1, “Installing GroupWise Mobile Server for Windows,” on page 39](#).

4.9 Upgrading an Evaluation License on Windows

For general GroupWise Mobile Server licensing entitlements, see [Section 1.11, “Licensing,” on page 13](#). Use the [Novell Customer Care Portal \(http://www.novell.com/company/customer\)](http://www.novell.com/company/customer) to upgrade an evaluation license to a permanent license.

After you have installed GroupWise Mobile Server for Windows and obtained a permanent license key:

- 1 In the Intellisync Mobile Suite Admin Console, select *Intellisync Mobile Suite*.
- 2 Click *Action > About Intellisync Mobile Suite*.
- 3 Click *License*.

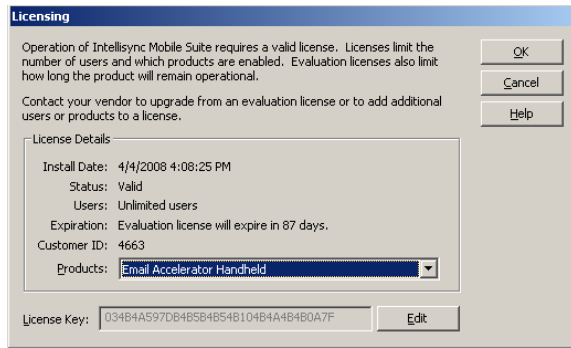

- 4 Click *Edit*, then delete the evaluation license key from the *License Key* field.
- 5 Select and copy your permanent license into the *License Key* field, then click *Apply*.
- 6 Click *OK* to put the new license into effect.

Initial Testing for GroupWise Mobile Server

5

After installing GroupWise® Mobile Server, test your system by using the instructions in this section.

- ♦ [Section 5.1, “Web Site Availability Test,” on page 57](#)
- ♦ [Section 5.2, “GroupWise Login Test,” on page 58](#)

5.1 Web Site Availability Test

This test verifies whether the GroupWise Mobile Server Web PIM site is available. Users can use the Web PIM site to verify their access to GroupWise Mobile Server, to configure their personal account settings, and to install GroupWise Mobile Server client software on their mobile devices, as described in [Section 6.3, “Using the Web PIM to Configure Device Synchronization Settings,” on page 62](#).

- ♦ [Section 5.1.1, “Without a Secure Gateway,” on page 57](#)
- ♦ [Section 5.1.2, “With a Secure Gateway,” on page 57](#)

5.1.1 Without a Secure Gateway

- 1 On the GroupWise Mobile Server machine, enter the Web PIM URL:
`http://localhost/en/logon.asp`

The Authentication window appears.

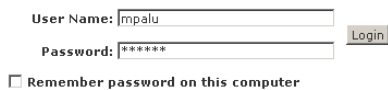

User Name:

Password:

Remember password on this computer

- 2 If you receive an HTTP error, try the following:
 - ♦ If a Web server was originally running on the Linux or Windows server before your installed GroupWise Mobile Server, make sure you have stopped the original Web server.
 - ♦ Restart the Linux or Windows server.

5.1.2 With a Secure Gateway

- 1 On the Secure Gateway machine, enter the Web PIM URL:
`http://localhost/en/logon.asp`

The Authentication window appears.

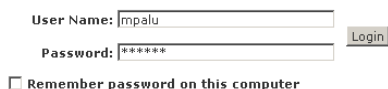

User Name:

Password:

Remember password on this computer

2 If you receive an HTTP error, try the following:

- ♦ Verify that the Secure Gateway address is correct.
In the Linux WebAdmin Console, click *System Settings > Secure Gateways*, click the Secure Gateway, then click *Edit* to verify the Secure Gateway address.
In the Windows Admin Console, select the Intellisync Mobile Suite object, then click *Action > Properties*. Click the *Secure Gateway* tab to verify the Secure Gateway address.
- ♦ If a Web server was originally running on the Linux or Windows server before your installed GroupWise Mobile Server, make sure you have stopped the original Web server.
- ♦ Restart the Linux or Windows server.

5.2 GroupWise Login Test

The easiest and best approach to user access is GroupWise authentication, which is the default at installation, as described in [Chapter 3, “Installing GroupWise Mobile Server for Linux,”](#) on page 19 and [Chapter 4, “Installing GroupWise Mobile Server for Windows,”](#) on page 39.

- ♦ [Section 5.2.1, “Logging In to GroupWise,”](#) on page 58
- ♦ [Section 5.2.2, “Successful Login,”](#) on page 58
- ♦ [Section 5.2.3, “Unsuccessful Login,”](#) on page 59

5.2.1 Logging In to GroupWise

On the GroupWise Mobile Server Web PIM Login page:

User Name:
Password:
 Remember password on this computer

1 Specify a valid GroupWise username and password, then click *Login*.

Depending on the computer capabilities, it might take some time to connect. The first access to GroupWise might be slower than subsequent accesses.

5.2.2 Successful Login

On successful authentication, the GroupWise Mobile Server uses the SOAP port you specified during the installation to query the GroupWise POA in order to gather user information. The most important information is mailbox discovery.

On first access, you are prompted to verify personal information:

| Next | Cancel | Help

Verify your account settings

Please fill in / verify the information below for mpatu.
 Note that the fields marked with red asterisks (*) are required.

Your location

Time Zone: Mountain Time (US & Canada) (GMT-7:00)

I've verified that the above time zone is correct *

Country: United States

Work Address:

City: *

State/Province: * ZIP/Postal Code: *

Your name and email address

First Name: null * Last Name: null *

Please enter your Email Address *

- 1 Enter at least the required information (marked with red asterisks), then click *Next*.
- 2 For instructions on using the Web PIM to access your GroupWise PIM data and configure your synchronization settings, see [Section 6.3, “Using the Web PIM to Configure Device Synchronization Settings,”](#) on page 62.

5.2.3 Unsuccessful Login

- ♦ [“General Troubleshooting Strategies”](#) on page 59
- ♦ [“Linux Troubleshooting Strategies”](#) on page 60
- ♦ [“Windows Troubleshooting Strategies”](#) on page 60

General Troubleshooting Strategies

- ♦ If the GroupWise Mobile Server does not recognize the account or password, the login fails. Make sure you typed the correct username and password, then try again.
- ♦ Make sure that the GroupWise user account exists in ConsoleOne®.
- ♦ Test the SOAP connection to the GroupWise POA by using the following command at a command prompt on the GroupWise Mobile Server machine:

```
telnet groupwise server_name 7191
```

You should receive the following response:

```
HTTP/1.0 500
Date: Wed, 26 Apr 2008 13:29:22 GMT
Server: Linux GroupWise POA 7.0.3
Content-Type: text/html
Pragma: no-cache
```

If the telnet session cannot connect, review the SOAP setup instructions provided in [Section 2.2, “Enabling POAs for SOAP,”](#) on page 15

- ♦ Use telnet sessions to test the connections from your workstation to the POA and to the GroupWise Mobile Server machine. Telnet sessions ensure that your firewall is not blocking any required connections.
- ♦ On the Settings page in the Web PIM, click the *Novell GroupWise (username)* link, then click *Test Access* to verify that the Web PIM can access the user’s GroupWise mailbox.

Linux Troubleshooting Strategies

- ♦ Make sure that the GroupWise Mobile Server processes are running, as described in [Section 3.2, “Starting and Stopping GroupWise Mobile Server on Linux,”](#) on page 21.

Windows Troubleshooting Strategies

- ♦ Make sure that the GroupWise Mobile Server services are running, as described in [Section 4.2, “Starting and Stopping GroupWise Mobile Server on Windows,”](#) on page 43.
- ♦ Try the additional troubleshooting strategies listed in “Logon Troubleshooting” in the *Intellisync Mobile Suite Installation Guide* (http://www.novell.com/documentation/gwmobility/pdfdoc/install_gde/install_gde.pdf)

Installing the Client Software and Configuring Device Synchronization

Mobile device users use the GroupWise Mobile Server Web PIM to configure synchronization settings and, optionally, to install GroupWise Mobile Server client software on their devices.

- ♦ [Section 6.1, “Starting the Web PIM for the First Time,” on page 61](#)
- ♦ [Section 6.2, “Installing the Client Software from the GroupWise Mobile Server URL,” on page 62](#)
- ♦ [Section 6.3, “Using the Web PIM to Configure Device Synchronization Settings,” on page 62](#)
- ♦ [Section 6.4, “Manuals and References for the Client Software,” on page 64](#)

6.1 Starting the Web PIM for the First Time

- 1 In your Web browser, open the Web PIM URL:

`http://localhost`

User Name:

Password:

Remember password on this computer

- 2 Log in, using your GroupWise username and password.

Next | Cancel | Help

— Verify your account settings —

Please fill in / verify the information below for mpalu.
Note that the fields marked with red asterisks (*) are required.

Your location

Time Zone: Mountain Time (US & Canada) (GMT-7:00)

I've verified that the above time zone is correct *

Country: United States

Work Address:

City: *

State/Province: * ZIP/Postal Code: *

Your name and email address

First Name: null * Last Name: null *

Please enter your Email Address *

- 3 On initial access, provide the required personal information, then click *Next* in the upper left corner of the page.

After initial access, you can update this information using the *General User Information* link.

On initial access, the list of available synchronization devices displays.

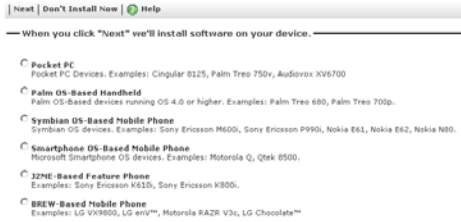

- 4 If you want to install the GroupWise Mobile Server client software from the Web PIM, select your mobile device, then click *Next*.

Options vary depending on the mobile device you select. Follow the on-screen instructions. After installing the GroupWise Mobile Server client software to your mobile device, skip to [Section 6.3, “Using the Web PIM to Configure Device Synchronization Settings,” on page 62.](#)

or

If you want to install the GroupWise Mobile Server client software by specifying the GroupWise Mobile Server URL on your mobile device, click *Don't Install Now*.

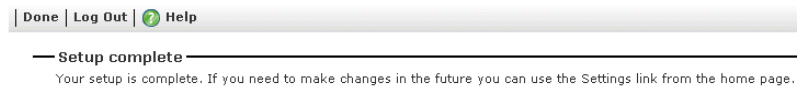

- 5 Continue with [Section 6.2, “Installing the Client Software from the GroupWise Mobile Server URL,” on page 62.](#)

6.2 Installing the Client Software from the GroupWise Mobile Server URL

- 1 On your mobile device, use the following URL to access GroupWise Mobile Server:

`http://GMS_server_address/install`

Specify the full IP address or DNS host name of the GroupWise Mobile Server machine. Instructions for installing GroupWise Mobile Server software on your particular mobile device are provided in the Nokia *Client Guides* on the [GroupWise Mobility Documentation Web page](http://www.novell.com/documentation/gwmobility/index.html) (<http://www.novell.com/documentation/gwmobility/index.html>).

- 2 After installing the software to your device, continue with [Section 6.3, “Using the Web PIM to Configure Device Synchronization Settings,” on page 62](#)

6.3 Using the Web PIM to Configure Device Synchronization Settings

- 1 Log in to the Web PIM again.

After the initial use, the Web PIM immediately displays the Sync Devices page.

Sync Devices

- [Add Sync Device](#) A device that stores email, PIM information, files, etc. locally
Examples: Pocket PC, Smartphone, Palm OS device
- [Add Alert Device](#) A device that receives short alert emails when important events occur
Examples: Mobile phones, pagers, email accounts
- [SyncML](#) SyncML devices are typically mobile phones with which you can sync your address book and calendar.
Examples: Sony Ericsson K750i, Nokia 6600/6822, Siemens S 55, etc..
- [Browse Info](#) Look up and edit your information on a web browser or WAP (Internet) phone.

Device Name	Sync	Most Recent	Push

[Pick Contacts to Sync](#) | [Push Settings](#) | [Alert Settings](#) | [Update Software](#) | [View Activity Log](#)

Server Connections

Connection Name:

Novell GroupWise (Mike Palu)
[Pick Folders to Sync](#)

- 2 To select personal address books to synchronize, click the *Pick Contacts to Sync* link, select options as desired, click *Save*, then click *Settings* to return to the Settings page.

The GroupWise Address Book or its subsets are made available by the GroupWise administrator, as described in [Section 3.5.4, “Configuring GroupWise Address Book Synchronization,” on page 26](#). Additional personal address books are available to users in the Web PIM.

- 3 To select folders in your mailbox to sync, click the *Pick Folders to Sync* link, select the folders you want on your mobile device, click *Save*, then click *Settings* to return to the Settings page.
- 4 To select personal Push settings for automatically synchronizing selected GroupWise item types on a specified schedule, click the *Push Settings* link, select options as desired, click *Save*, then click *Settings* to return to the Settings page.

The default Push settings are configured by the GroupWise administrator, as described in [Section 3.8.5, “Configuring SMTP Relay for SMS Push,” on page 35](#).

- 5 Select other personal settings as desired.
- 6 Click *Save*, then click *Done*.

This displays what has synchronized from your GroupWise mailbox to GroupWise Mobile Server. When you provision your mobile device, GroupWise Mobile Server downloads this GroupWise data to your device.

New	X	Search	Clear	Help																									
Mike Palu					Page 1																								
<input type="checkbox"/>	<input type="checkbox"/>	<input type="checkbox"/>	<input type="checkbox"/>	<input type="checkbox"/>	<table border="1" style="width: 100%; border-collapse: collapse;"> <thead> <tr> <th style="width: 10%;">From</th> <th style="width: 50%;">Subject</th> <th style="width: 40%;">Received</th> </tr> </thead> <tbody> <tr> <td>Alfons Skoczylas</td> <td>Demonstrations</td> <td>March , 2008 11:12 AM</td> </tr> <tr> <td>Tabitha Hu</td> <td>Reality Check</td> <td>February 28, 2008 11:03 AM</td> </tr> <tr> <td>Tabitha Hu</td> <td>Re: Are You Ready</td> <td>February 22, 2008 11:15 AM</td> </tr> <tr> <td>Tabitha Hu</td> <td>Are You Ready</td> <td>February 22, 2008 11:15 AM</td> </tr> <tr> <td>Charles Bolton</td> <td>Meeting</td> <td>February 22, 2008 11:11 AM</td> </tr> <tr> <td>Grace Smith</td> <td>Lunch</td> <td>February 22, 2008 11:05 AM</td> </tr> <tr> <td>Tabitha Hu</td> <td>Re: Reality Check</td> <td>February 22, 2008 11:04 AM</td> </tr> </tbody> </table>	From	Subject	Received	Alfons Skoczylas	Demonstrations	March , 2008 11:12 AM	Tabitha Hu	Reality Check	February 28, 2008 11:03 AM	Tabitha Hu	Re: Are You Ready	February 22, 2008 11:15 AM	Tabitha Hu	Are You Ready	February 22, 2008 11:15 AM	Charles Bolton	Meeting	February 22, 2008 11:11 AM	Grace Smith	Lunch	February 22, 2008 11:05 AM	Tabitha Hu	Re: Reality Check	February 22, 2008 11:04 AM
From	Subject	Received																											
Alfons Skoczylas	Demonstrations	March , 2008 11:12 AM																											
Tabitha Hu	Reality Check	February 28, 2008 11:03 AM																											
Tabitha Hu	Re: Are You Ready	February 22, 2008 11:15 AM																											
Tabitha Hu	Are You Ready	February 22, 2008 11:15 AM																											
Charles Bolton	Meeting	February 22, 2008 11:11 AM																											
Grace Smith	Lunch	February 22, 2008 11:05 AM																											
Tabitha Hu	Re: Reality Check	February 22, 2008 11:04 AM																											

- 7 Review the GroupWise PIM data to see if it is what you want to synchronize to your mobile device, then click *Next*.

GroupWise Mobile Server now synchronizes the PIM data to your mobile device.

6.4 Manuals and References for the Client Software

In addition to this guide, the following client documentation is provided in Adobe Portable Document Format (PDF), at the [GroupWise Mobility Documentation Web site \(http://www.novell.com/documentation/gwmobility\)](http://www.novell.com/documentation/gwmobility):

- ♦ *Palm Client User Guide*
- ♦ *Pocket PC Client User Guide*
- ♦ *Smartphone Client User Guide*
- ♦ *Symbian60 Client User Guide*
- ♦ *Symbian80 Client User Guide*
- ♦ *SymbianUIQ Client User Guide*
- ♦ *SymbianUIQ3 Client User Guide*
- ♦ *J2ME Client User Guide*

NOTE: BREW devices are supported by GroupWise Mobile Server but not by Nokia Intellisync Mobile Suite. Refer to your BREW device documentation for installation instructions.
